

bycool!
green line

COMPACT 1.4
VOLVO



Instrucciones de Montaje

Mounting Instructions

Instructions de Montage

Montageanweisungen

Istruzioni di Montaggio

ES Spanish

EN English

FR French

GE German

IT Italian

Recomendaciones Para el montaje

- Antes de iniciar el montaje leer las instrucciones y seguirlas durante el proceso de instalación.
- Usar las herramientas adecuadas para cada operación.

Electricidad

- Desconectar la llave de contacto.
- Desconectar la batería antes de empezar el montaje.
- Asegurar el conexionado de los componentes eléctricos, verificando su correcto encaje.

Atención

Si durante el montaje el equipo se inclina ó se abate la cabina con el equipo montado, se deberá esperar un mínimo de 60 minutos, desde que el equipo quede horizontal, antes de ponerlo en marcha.

Atención

Al instalar el equipo de aire acondicionado en el techo se debe proteger la parte superior de la cabina con un paño ó manta protectora para evitar posibles arañazos. Al instalar **Compact** en el techo hay que tener en cuenta que, normalmente, las cabinas que vienen provistas de escotilla, tienen una estructura suficiente para soportar el peso del equipo. Sin embargo, cuando no ocurra así y sea necesario realizar corte en el techo ó incluso si en el caso de llevar escotilla el material no es lo suficientemente resistente (caso de techo de fibra, plástico, etc...) es el instalador el que debe decidir, **bajo su responsabilidad**, sobre la necesidad de reforzar el techo para evitar posibles deformaciones, roturas, entradas de agua, etc... habilitando los medios para que esto no ocurra.

Herramientas

Juego de Llaves Torx

Juego de Llaves Allen

Llave fija 10, 13, 14

Tijeras

Flexómetro

Documentación incluida

Instrucciones de montaje	220.AA6.0410
Manual del usuario	220.AA6.0170
Diagnosis de averías	220.AA6.0013
Garantía	220.AA1.0017

Simbología



Frágil





Atención corte!



Riesgo eléctrico

Advertencias

 El personal instalador debe poseer una formación suficiente en Aire Acondicionado de vehículos.

 **dirna Bergstrom, s.l.** queda exenta de responsabilidad si se producen averías que procedan de una inadecuada manipulación ó instalación del equipo, ó por modificaciones y sustituciones efectuadas sin nuestra expresa autorización por escrito.

 **Equipo precargado con gas refrigerante. (No manipular el circuito de gas refrigerante).**

 Véase **procedimiento de garantía** del producto incluido en **Diagnosis de Averías**.

 Véase **Manual de Usuario** del equipo para el correcto funcionamiento del mando a distancia y del panel de control.

 Al finalizar la instalación se debe entregar al usuario: **Manual del Usuario, Garantía y Diagnosis de averías.**

 Antes de empezar con el montaje, montar rejilla entrada aire delantera.



1 Desmontar tapa escotilla, los elementos de fijación y entregar éstos al cliente.

 Si el vehículo incorpora spoiler es necesario desmontarlo para iniciar la instalación del equipo.

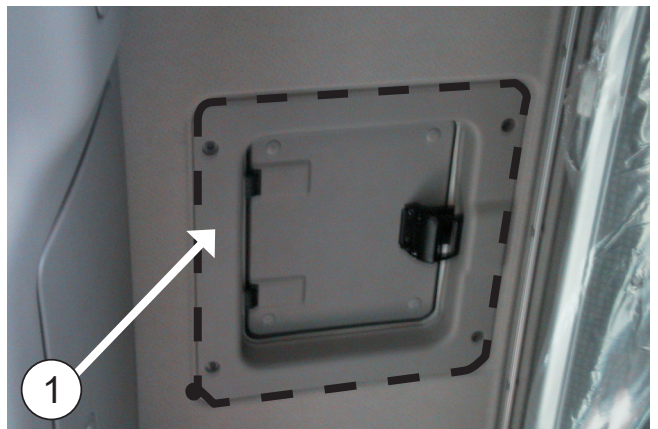
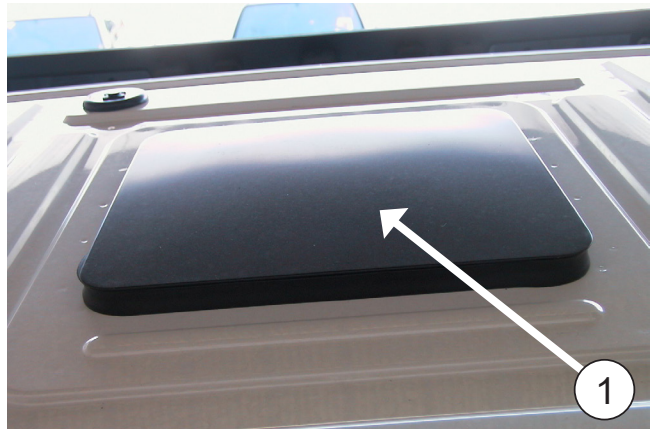

2 Pegar junta alrededor del hueco de escotilla respetando medida indicada, para que la recirculación quede dentro de la junta EPDM.

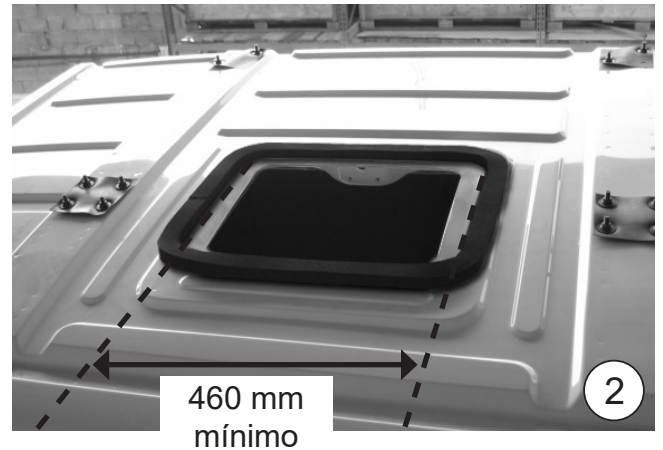

2a Detalle de la colocación de la junta.



COMO CORTAR LA JUNTA EPDM PARA EVITAR FILTRACIÓN DE AGUA EN LA CABINA

- A-** Pegar la junta, manteniendo 100 mm de papel protector por cada lado.
- B-** Quitar los dos piezas de papel.
- C-** Pegue presionado ambos finales.

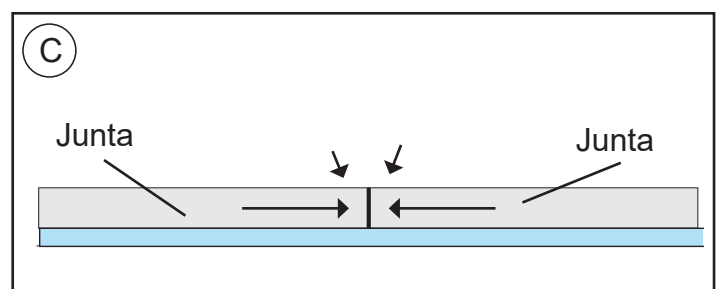
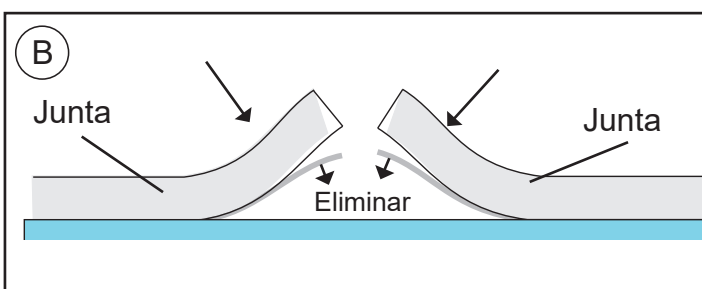
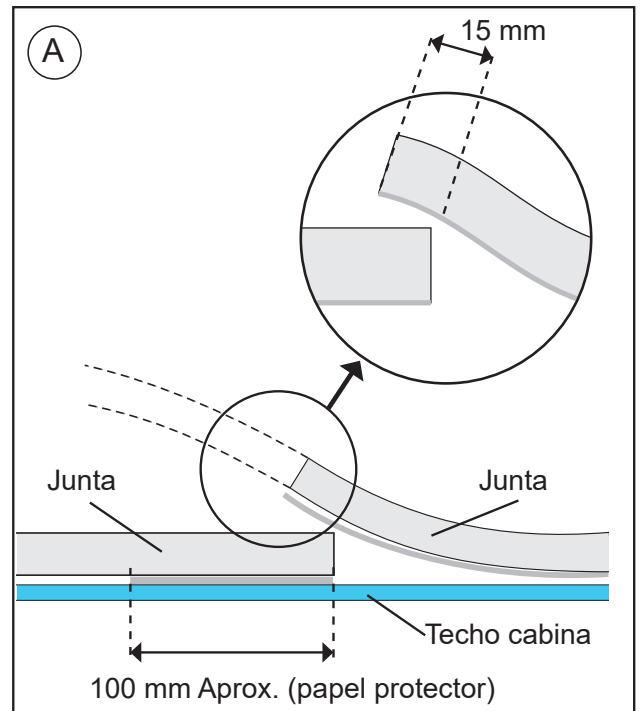

3 EXTERIOR CABINA:

Posicionar el Compact en el hueco de la escotilla.

¡Atención! Al colocar el equipo encima del hueco escotilla, revisar que las salidas de desagüe no queden obstruidas por la junta EPDM

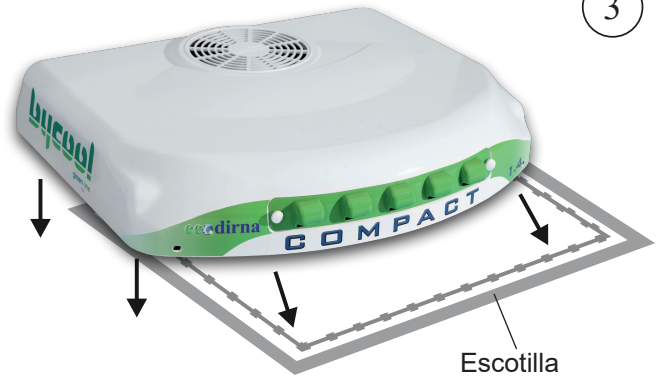

4 INTERIOR CABINA:

Roscar 5 mm aproximadamente (4) espárragos M6/100x120 en la base del Compact.

Desde el punto 5 hasta el punto 10 las operaciones realizadas se harán para conseguir que el Compact quede centrado, por lo que no se hacen aprietes totales.

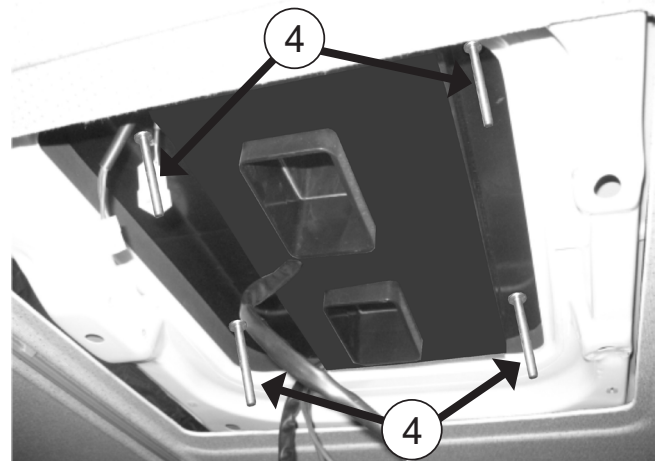

5 Colocar (1) arandela Ø 6 de goma, (1) arandela plana Ø 6 ala ancha, (2) tuerca M6 y (1) arandela plana Ø 6 ala ancha, en cada uno de los espárragos anteriores.

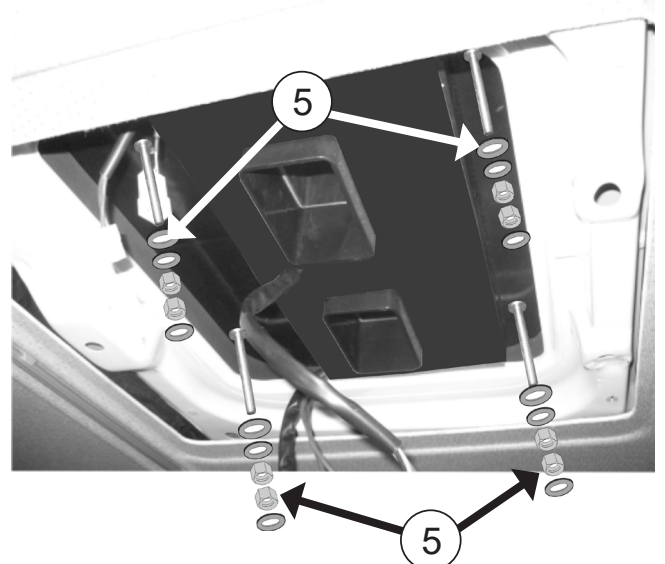

5a Posicionar (2) soportes sujeción sobre los espárragos entre el tapizado y la estructura metálica de la cabina.

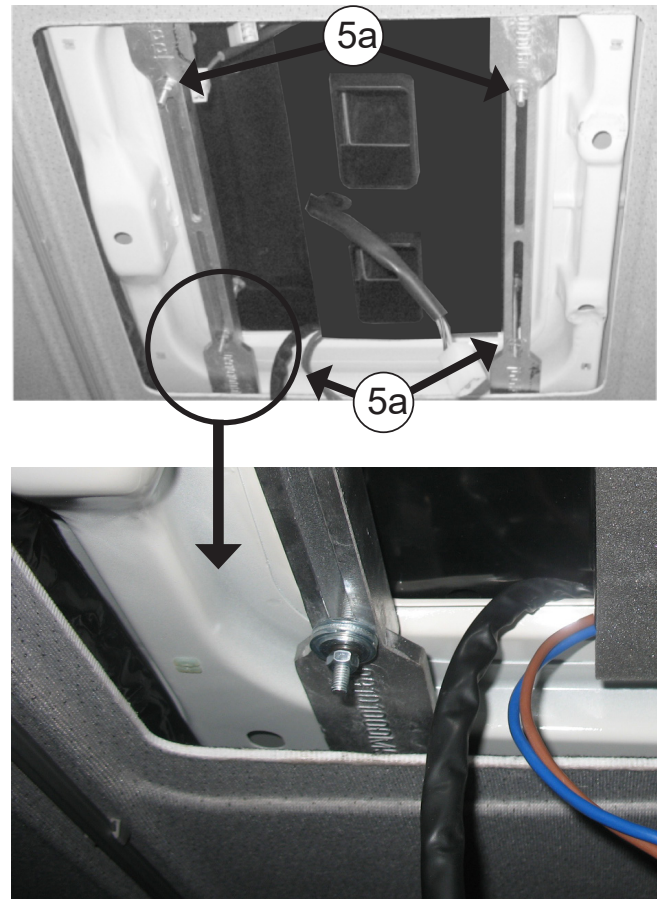

6 Colocar canalizador gomaespuma quedando la parte más blanda en la base del equipo.



7 Entre equipo y panel interior de distribución de aire, conectar las (2) cajas de 4 vías; las (2) cajas de 2 vías y conectar cableado de alimentación en caja de 2 vías en "T".
ATENCIÓN: Es muy importante no invertir los colores de la caja de dos vías del ventilador del condensador (caja con cables R y N).

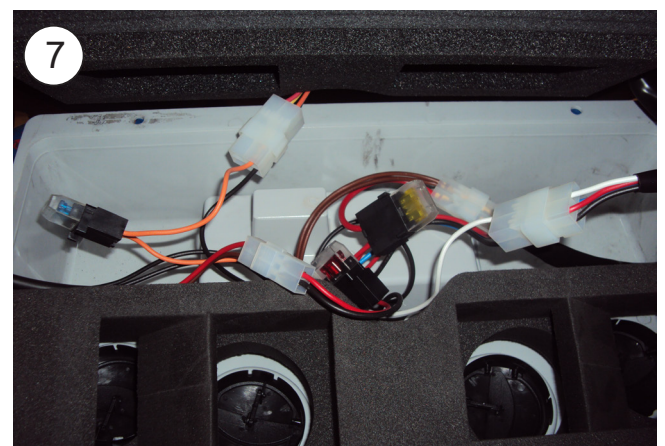

8 Introducir cableados en el hueco existente (H) en el panel interior de distribución de aire para no interferir en el ajuste de los canalizadores con la base del equipo.

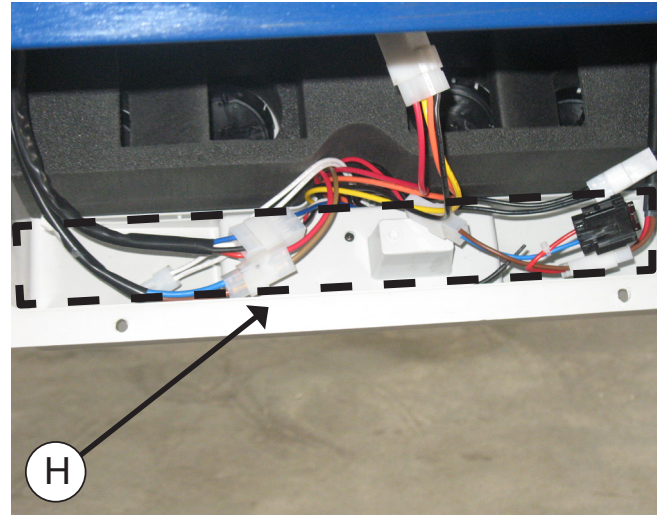

9 Presentar conjunto panel interior de distribución de aire sobre los soportes de fijación (4) arandelas planas de 6 mm), fijándolo con tuercas (4) M6 autoblocantes, y roscar sin llegar a apretar.

Importante: Los canalizadores deben hacer tope contra la goma espuma para evitar fugas de aire.



10 Presentar consola con tornillos originales y centrar en el Compact en la posición más idónea hasta hacer coincidir los tornillos originales en su ubicación.



11 Una vez realizadas estas operaciones, desmontar consola, apretando las tuercas (A) hasta que la junta EPDM se comprima entre 3 y 5 mm aproximadamente posteriormente apretar tuercas a base del Compact (B) y tuercas superiores del soporte C. Esquema A.

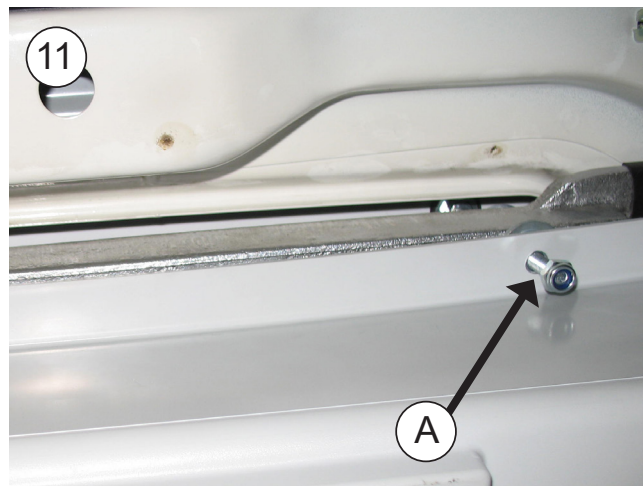

Importante: Para evitar posibles filtraciones de agua, asegurar el apriete de la junta con la base del Compact - Par de apriete 1.3 a 1.8 Kg Tal como se indica en el Esquema A.

Apretar tuercas "A" hasta el apriete de la junta entre 3 y 5 mm y después apretar tuercas "B" y "C".

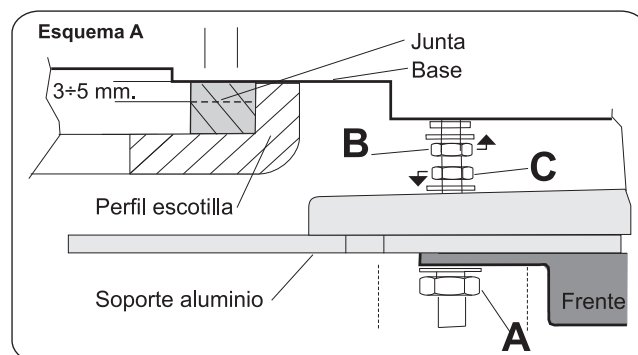

12 Volver a montar consola con los tornillos originales.

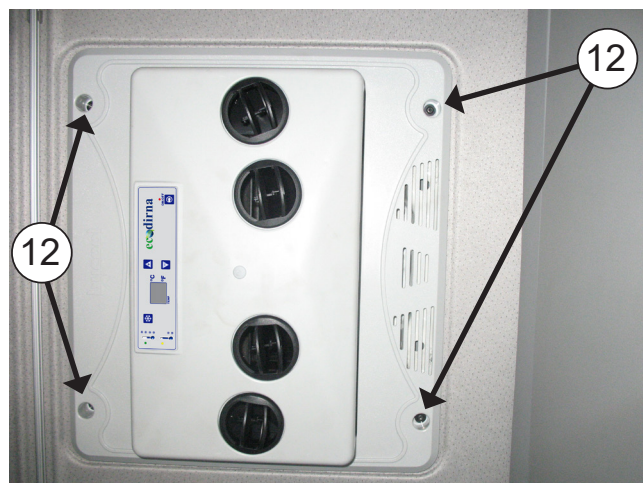

Vista explosionada hasta la fijación de los soportes

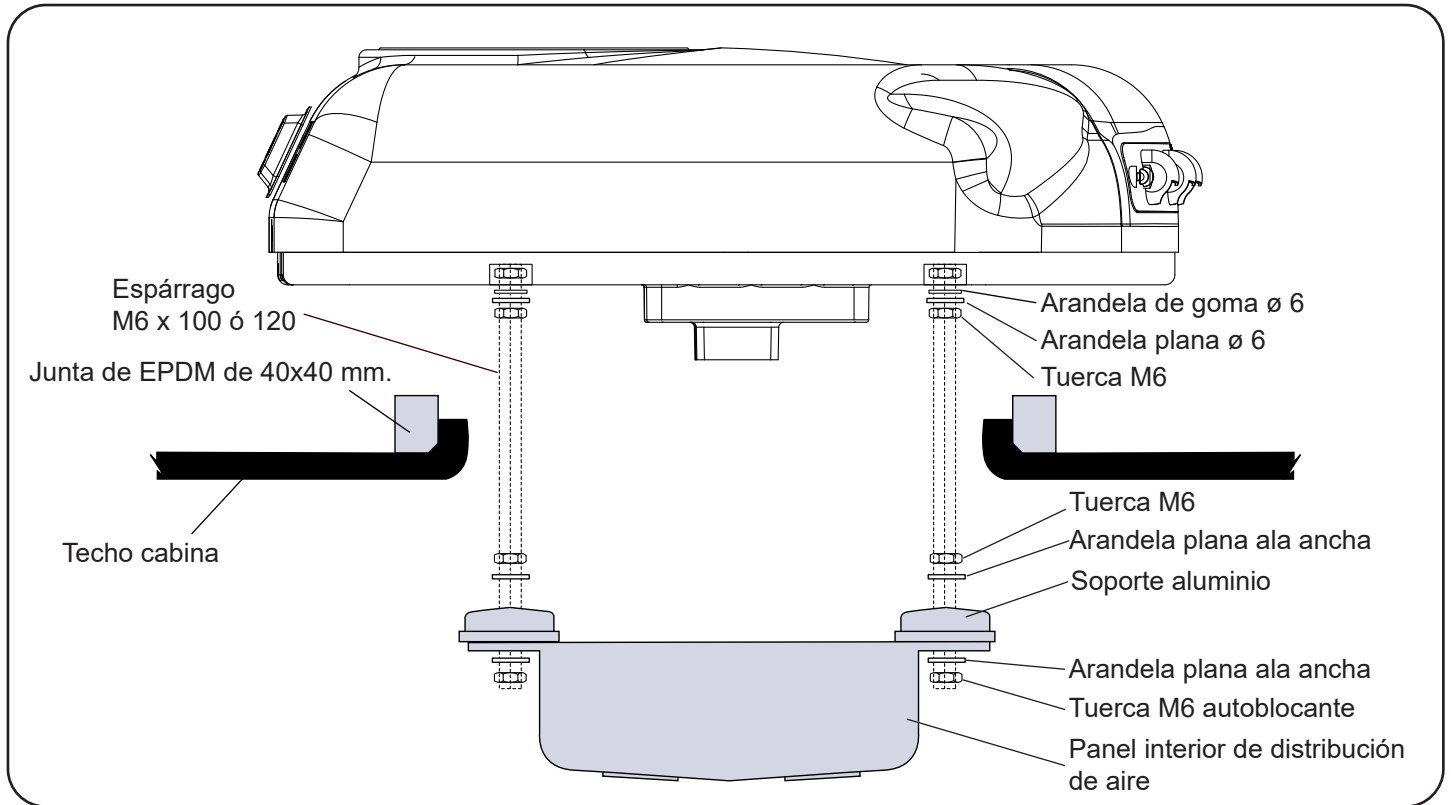

Vista explosionada hasta la fijación de las consolas

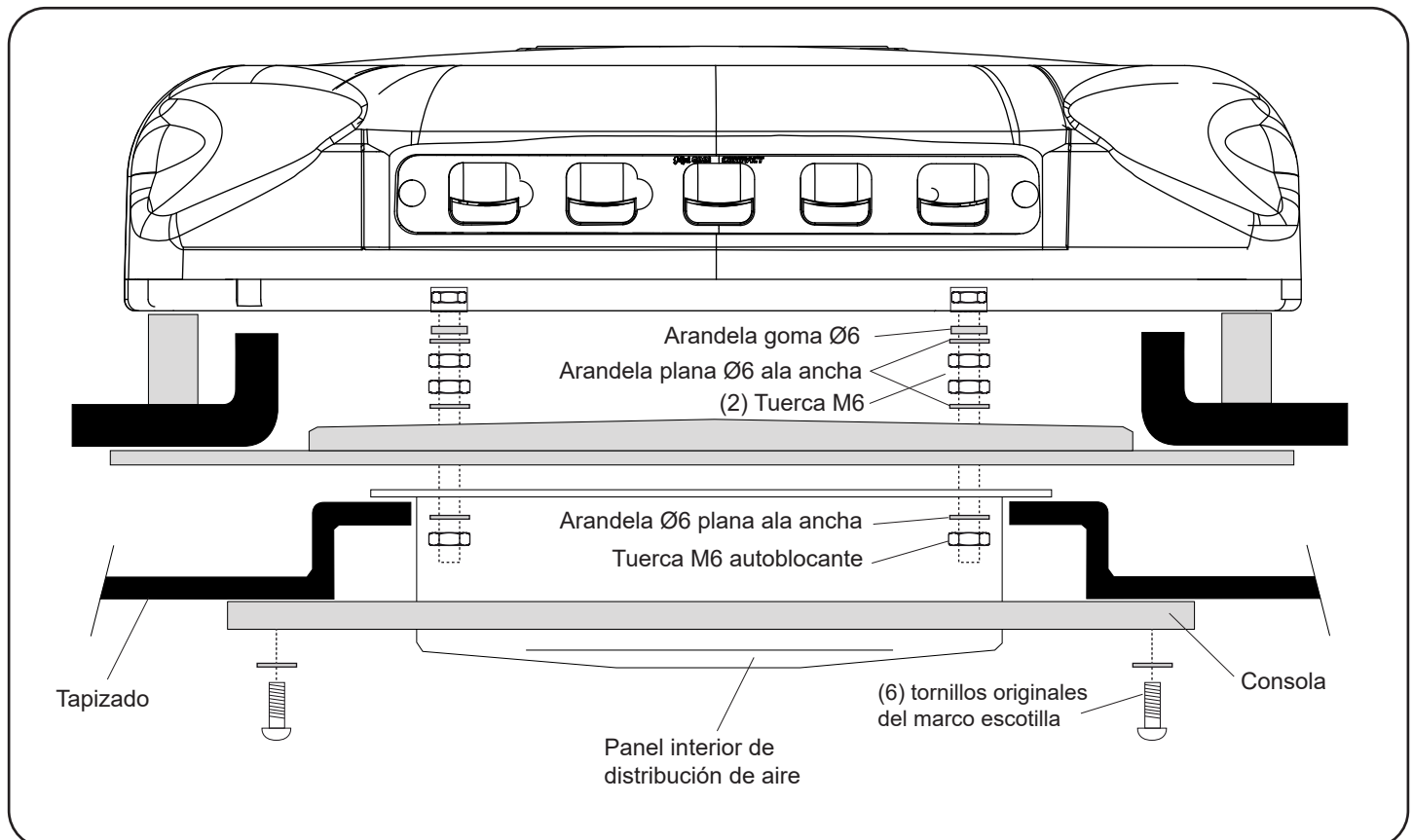

Instrucciones detalladas sobre instalación del cableado de alimentación

1 Conectar clema del cable de alimentación con la clema del equipo y pasar cableado por detrás del tubo de admisión.

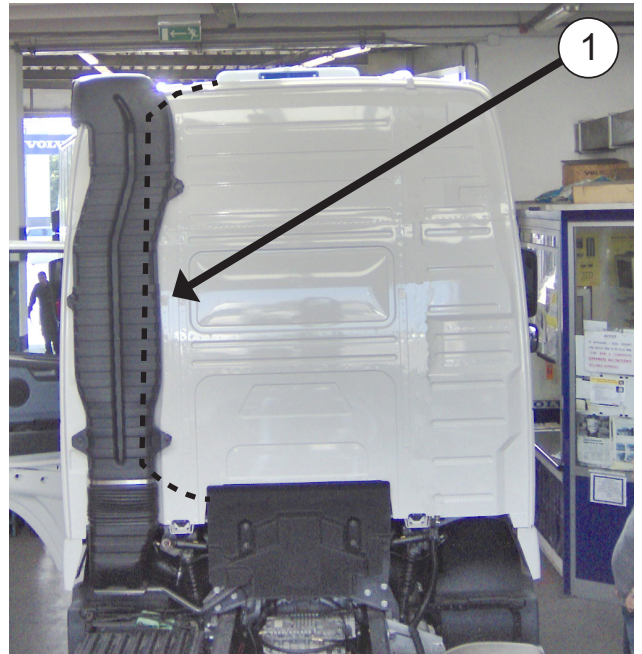
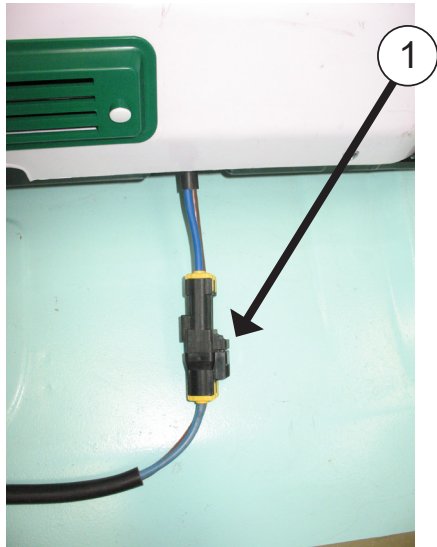

2 Abatir cabina y llevar cable por el lugar indicado hasta la toma de positivo situada en la parte delantera de la cabina.

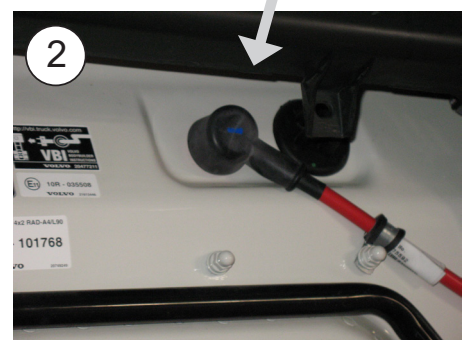
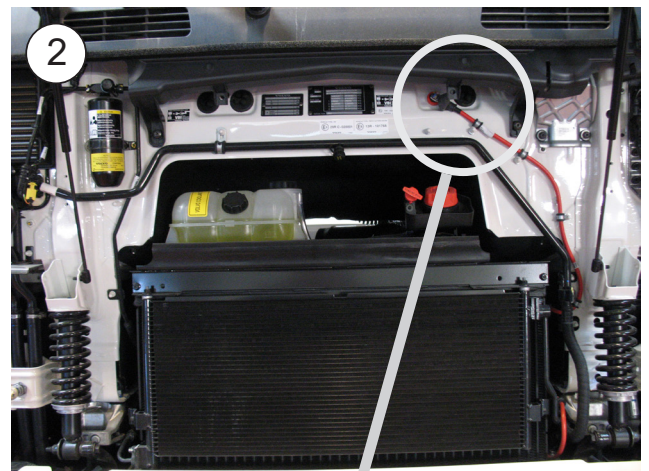
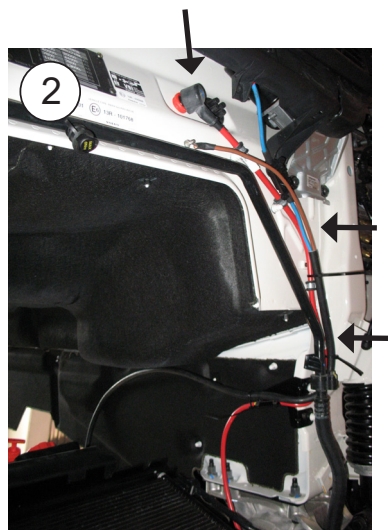
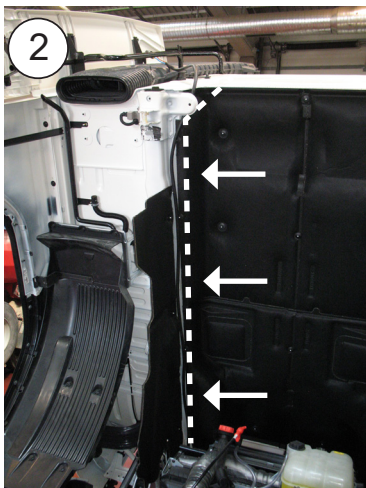

3 Desmontar tuerca M6 y tuerca M8 de toma (+) y conectar cableado de alimentación como se indica.

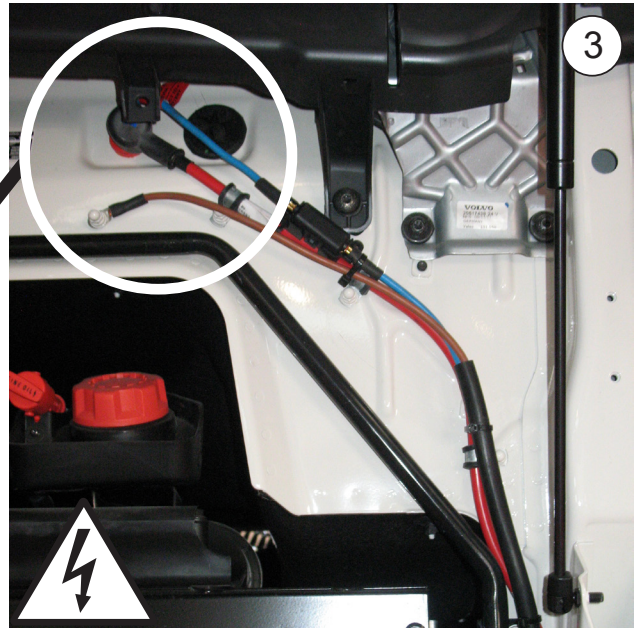
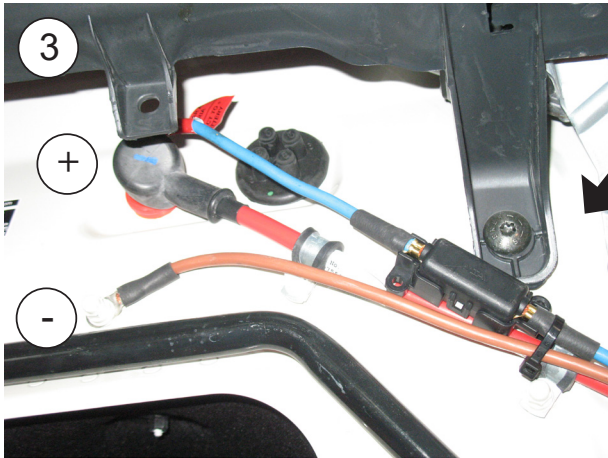

4 Fijar cableado con bridas a cable original.



5 En parte inferior de la cabina fijar con abrazaderas a espárragos originales.

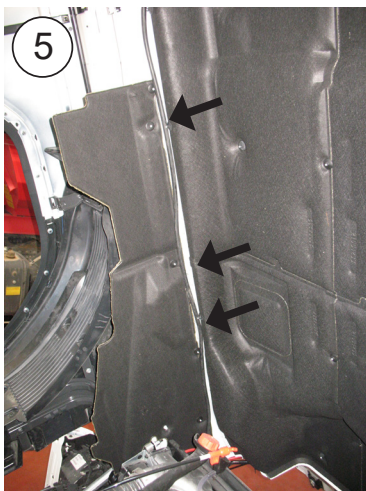

6 Abatir cabina y dejar en posición de marcha, perder cableado sobrante detrás del tubo de admisión.

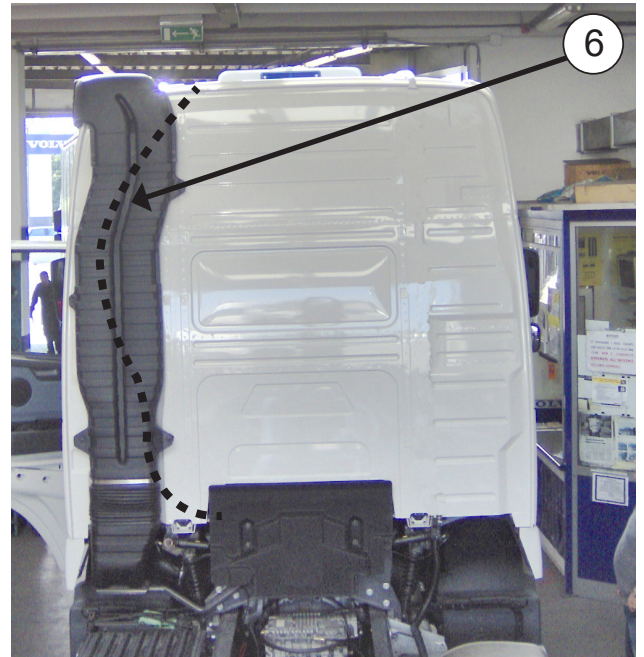

 Si el vehículo incorpora spoiler es necesario realizar las modificaciones indicadas antes de volver a instalar el spoiler en su posición de origen.

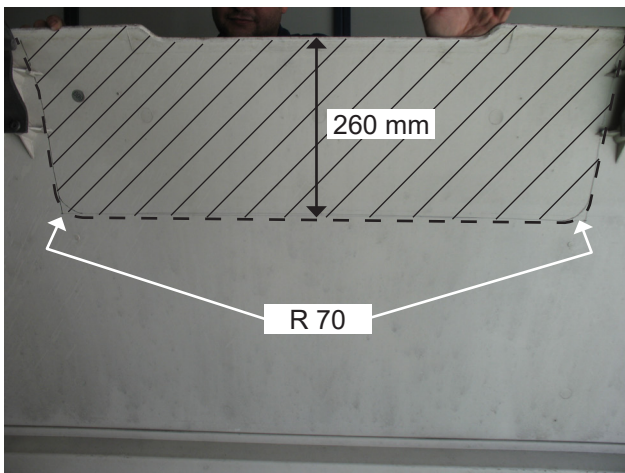

Vista por la parte inferior del spoiler. Efectuar corte a medidas indicadas.



Esquema eléctrico

¡AVISO IMPORTANTE!

Precaución de no invertir las polaridades al conectar el equipo a la batería. Si esto sucediera la placa de mandos no se enciende y el equipo no funciona.

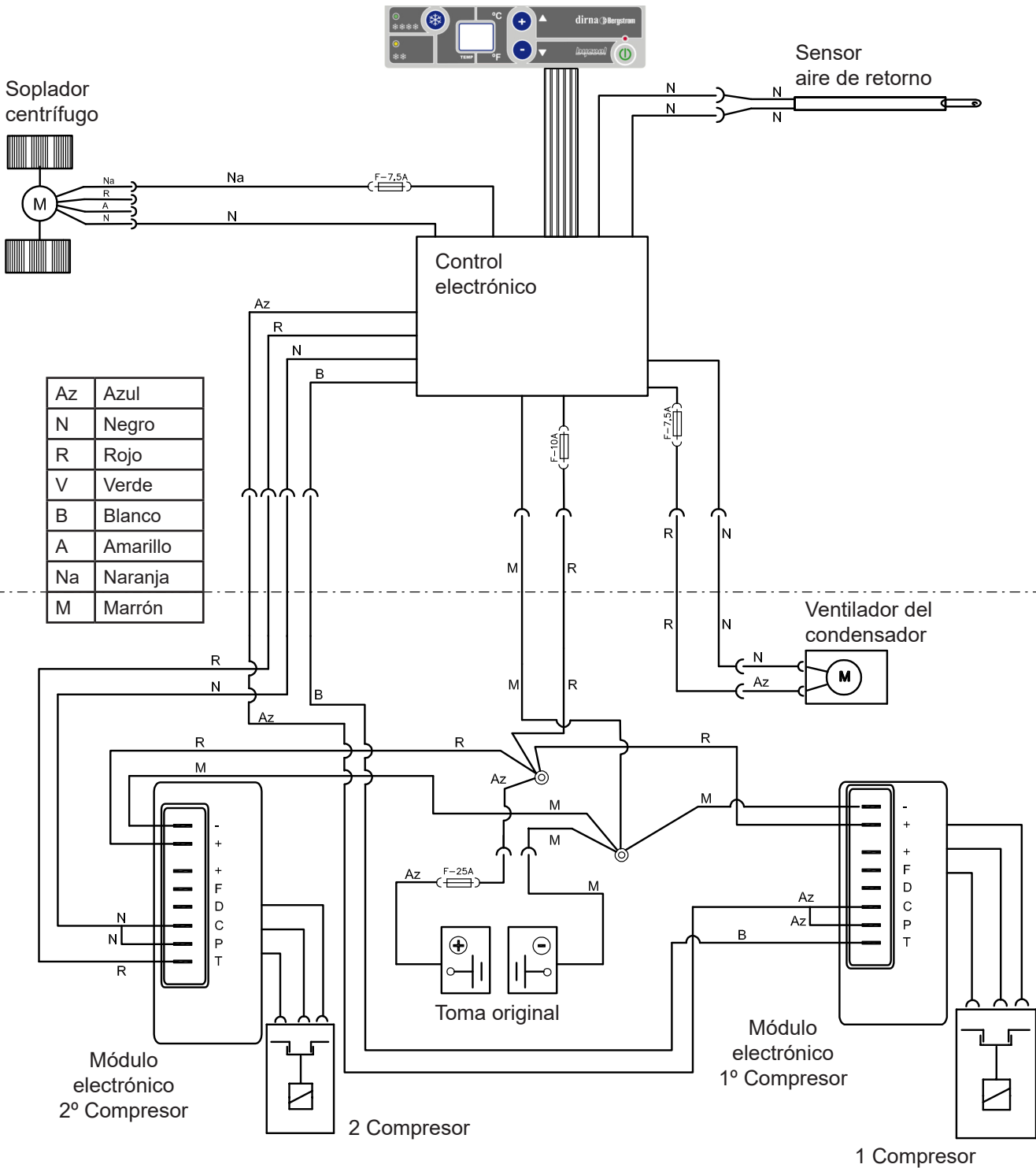

Assembly Recommendations

- Before starting assembly, please read instructions and follow them during installation process.
- Use the adequate tools for each operation.

Electricity

- Disconnect ignition key.
- Disconnect battery before starting assembly.
- Make sure electric components are securely connected, checking their correct fitting.

Warning

If the unit slants during assembly, wait for at least 60 minutes with the unit in horizontal position before starting it up.

Warning

When installing air conditioning equipment on roof, the upper cabin part must be protected with a cloth or a protective blanket to avoid possible scratches. When installing **Compact** on roof, take into account that, normally, cabins equipped with a hatch have a strong enough structure to hold equipment weight. However, if it is not the case and it is necessary to carry out a cut in the roof or, although it has a hatch, the material is not resistant enough (*if roof is made of fibre, plastic, etc...*), it is the installer who will have to decide, under his responsibility, if it is necessary to reinforce the roof to avoid possible deformations, breaks, water entries, etc., habituating the means required to stop it from occurring.

Tools

Torx wrenches set
 Allen wrenches set
 Open-jawed spanner 10, 13, 14
 Scissors
 Flexo-meter

Documentation included

Mounting instructions	220.AA6.0410
User's guide	220.AA6.0170
Troubleshooting	220.AA6.0013
Warranty	220.AA1.0017

Symbology



Fragile









Beware of cuts!



Electrical hazard

Warnings

-  The installing personnel must have a sufficient training in vehicles air conditioning.
-  **dirna Bergstrom, s.l.** shall not be responsible for breakdowns or damages coming from an inadequate handling or installation of the equipment or from modifications and substitutions carried out without our express and written authorisation.
-  **Equipment pre-charged with refrigerating gas. (Do not handle refrigerating gas circuit).**
-  Please see product **warranty procedure** included in **Troubleshooting**.
-  Please see equipment **User's Guide** for its correct functioning of the remote control and control panel.
-  Once installation is finished, the following documents must be handed over to the user: **User's Guide, Warranty and Troubleshooting**.

 Mount the front air input grille before starting assembly.



1 Dismount the hatch cover and the inner frame, and give to the customer.

 If the vehicle has a spoiler fitted, remove it before installing the unit.

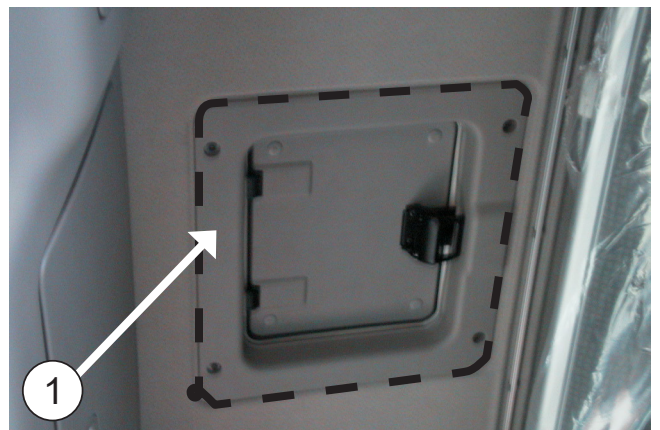
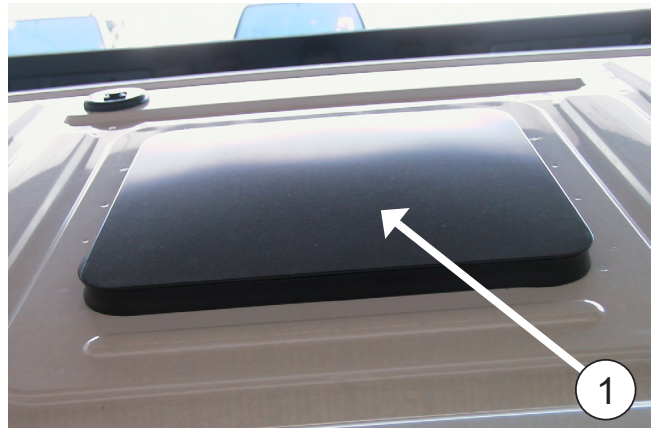

2 Attach the seal around the hatch gap, respecting the indicated measurement, in order to ensure recirculation remains within the EPDM seal.

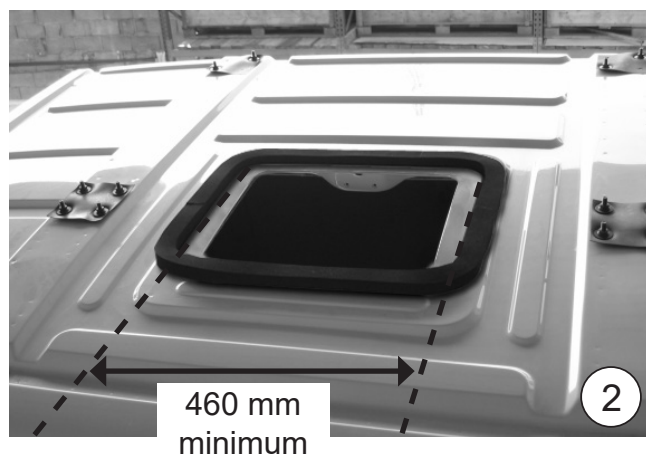

2a Details of the positioning of the seal.



! HOW TO CUT EPDM GASKET TO AVOID WATER FILTRATION INTO THE CABIN

- A-** Glue gasket, keeping 100 mm of protection paper at each side.
- B-** Remove the two pieces of paper.
- C-** Glue by pressing both ends.

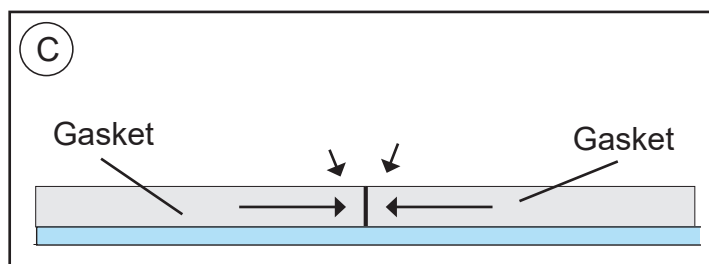
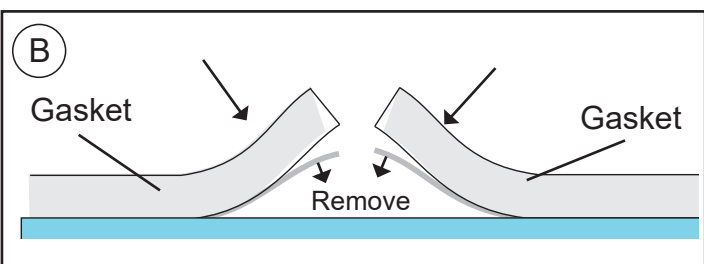
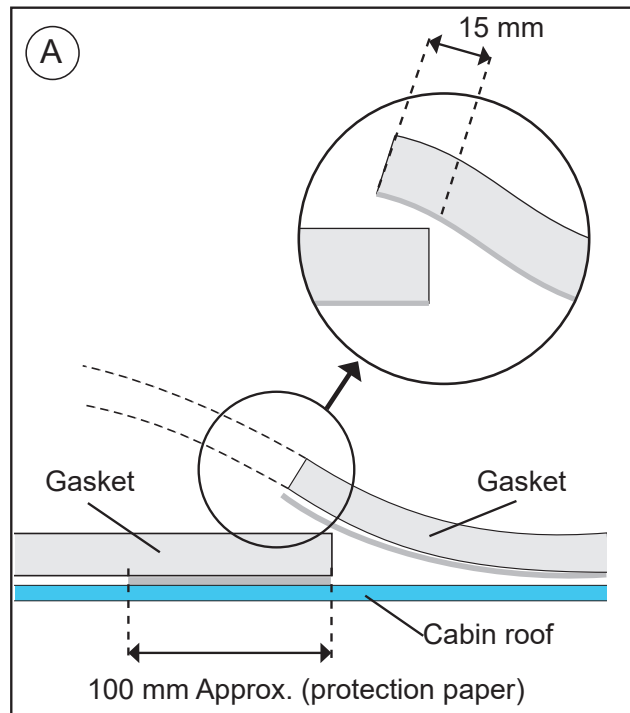

3 OUTSIDE CABIN:

Position **Compact** in sun hatch hole.

CAUTION! When positioning the unit above the hatch gap, check that the wastewater run-offs are not blocked by the EPDM seal.

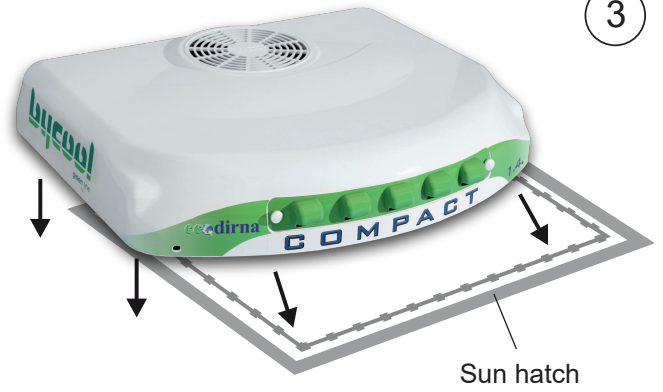

4 CABIN INTERIOR:

Thread 5 mm approximately (4) studs 6/100x120 in the base of the **Compact**.

From point 5 up to point 10 the operations carried out are to align the **Compact**, which is why there is no full tightening.

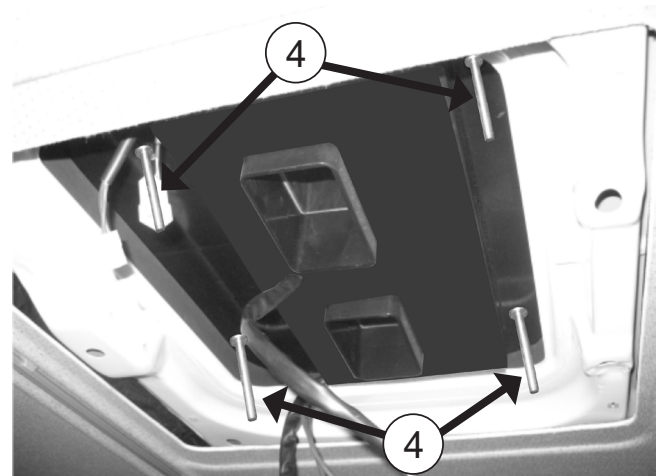

5 Position (1) rubber washer Ø 6, (1) wide flanged Ø 6 flat washer, (2) M6 nut and (1) wide flanged Ø 6 flat washer, in each one of the previous studs.

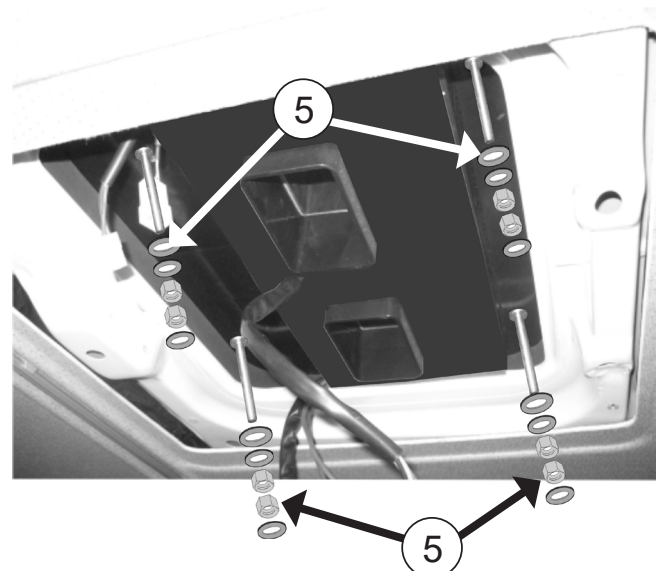

5a Position (2) attachment supports on the studs between the outer cover and the metallic structure of the cabin.

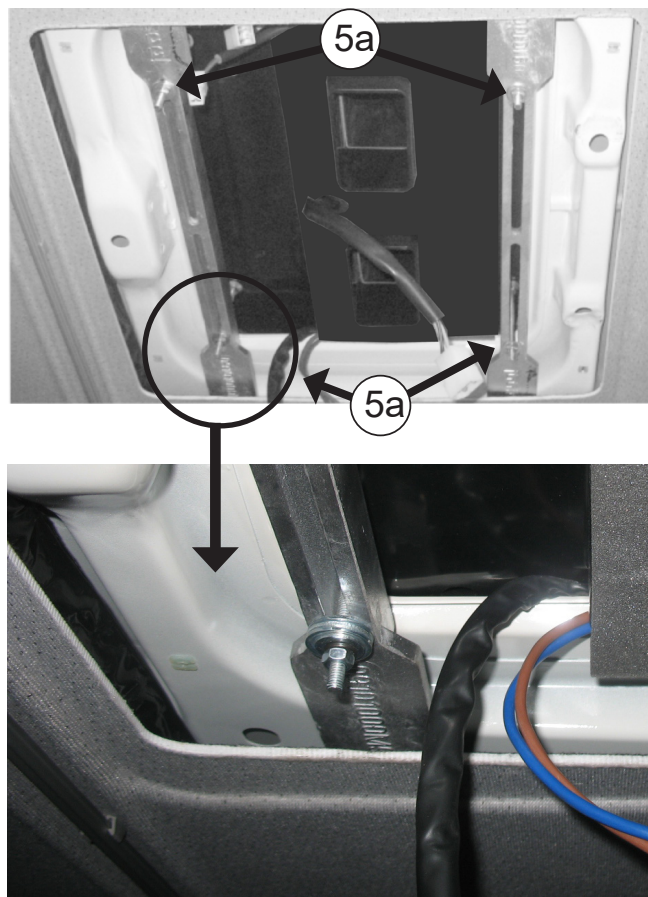

6 To place the foam rubber ducting remaining at the softer part of the base.



7 Connect the (2) 4-way boxes and the (2) 2-way boxes and connect the power cable in the 2-way box in a "T" between the unit and the interior air distribution panel.

NOTE: It is very important not to invert the colours of the condenser fan 2-way box (box with R and N wires).

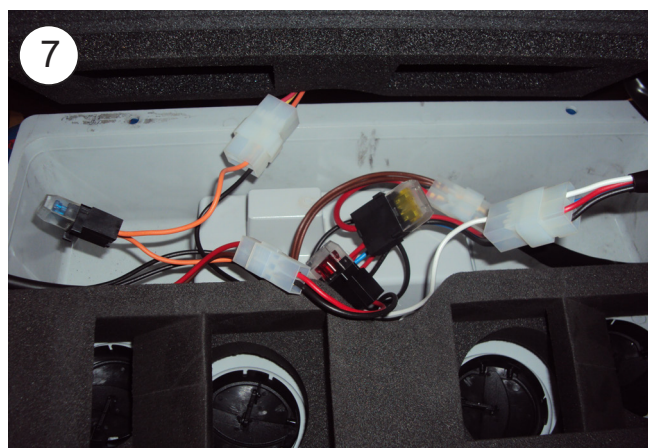

8 Introduce the cabling in the gap (H) in the interior air distribution panel in order not to interfere in the adjustment of the ducts with the base of the unit.

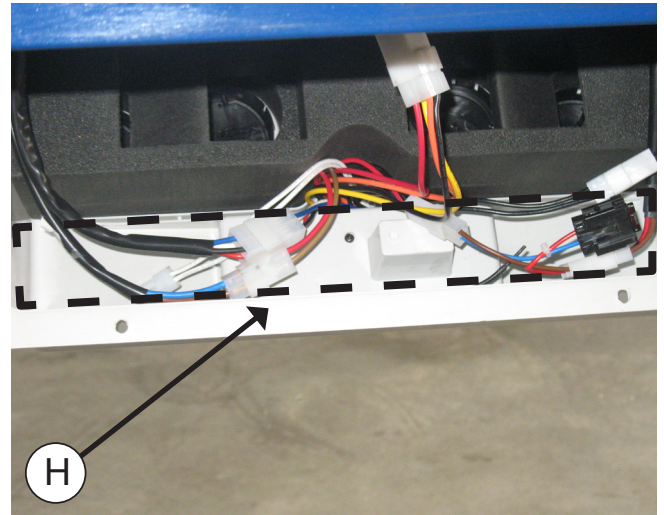

9 Place the interior air distribution panel on the fastening mounts with (4) 6 mm flat washers, securing with (4) M6 self-locking nuts, and screw without tightening.

Important: The channelling equipment should come to a stop against the foam rubber in order to prevent leakages of air.



10 Place the console using original screws and align in the Compact in the most ideal position, until the original screws coincide in their location.



11 Once these operations are complete, dismount the console, turning the nuts (A) until the EPDM seal is compressed between 3 and 5 mm approximately, then turn the nuts at the base of the Compact (B) and the upper nuts of support C. Diagram A.

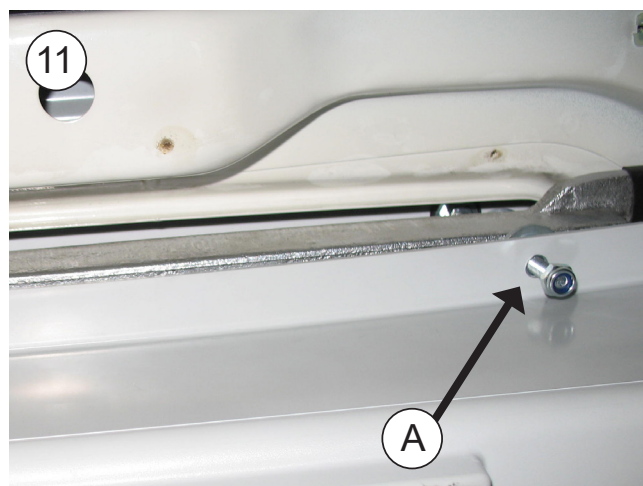

Important: In order to prevent possible filtrations of water, ensure the seal is tight with the base of the Compact - Torque 1.3 a 1.8 kg. As indicated in Diagram A.

Turn nuts "A" to tighten the seal between 3 and 5 mm and then tighten nuts "B" and "C".

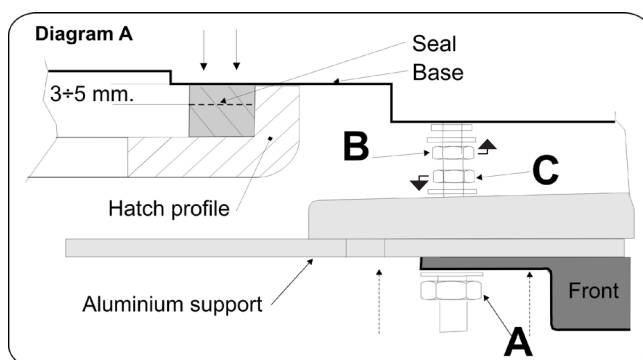

12 Mount the console again using the original screws.

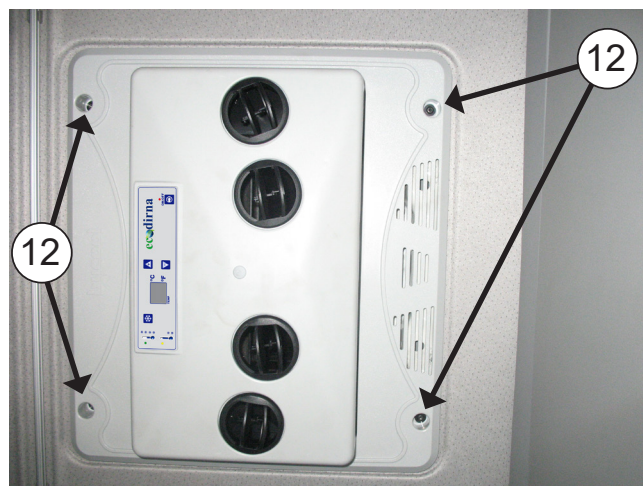

Exploded view up to supports fastening

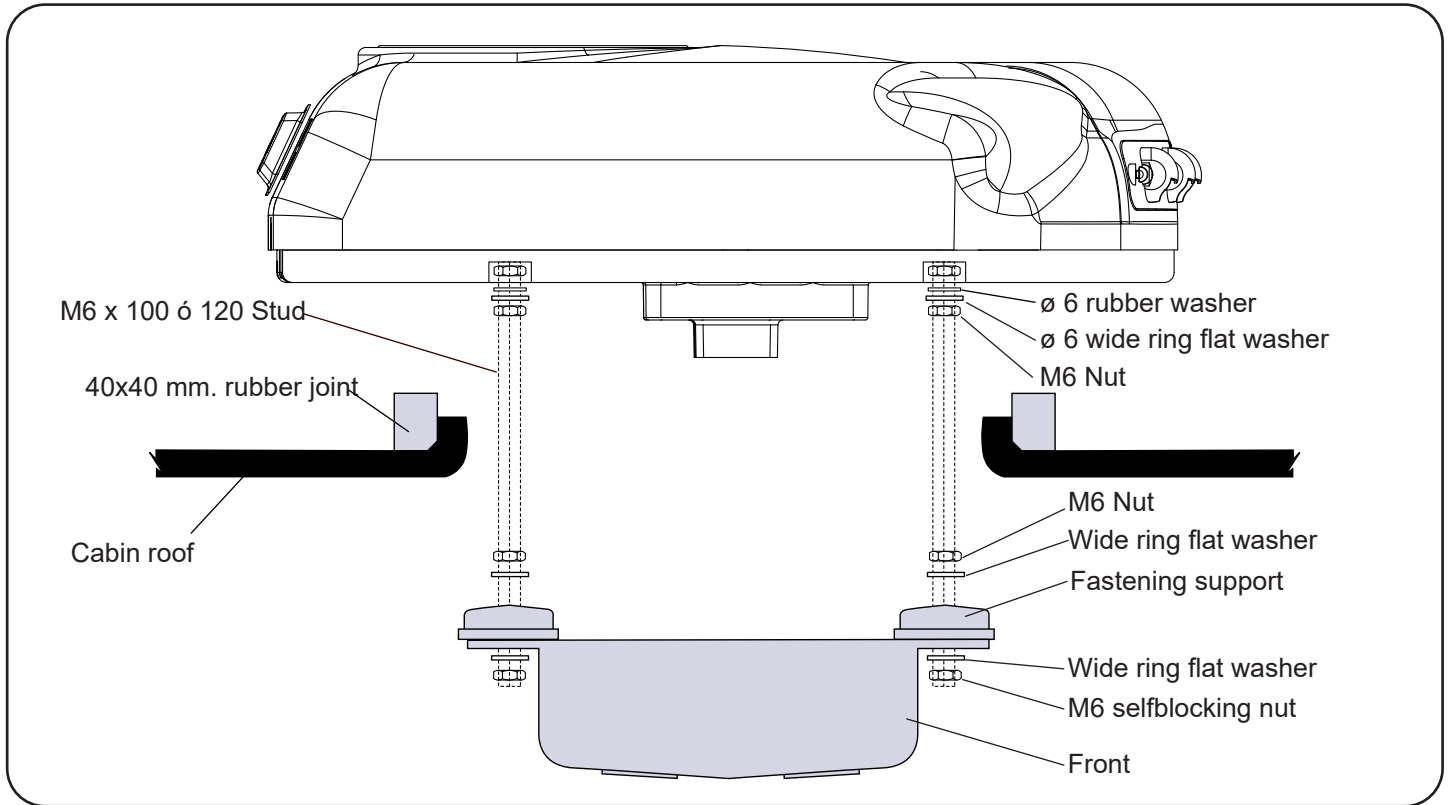

Exploded view up to console fastening

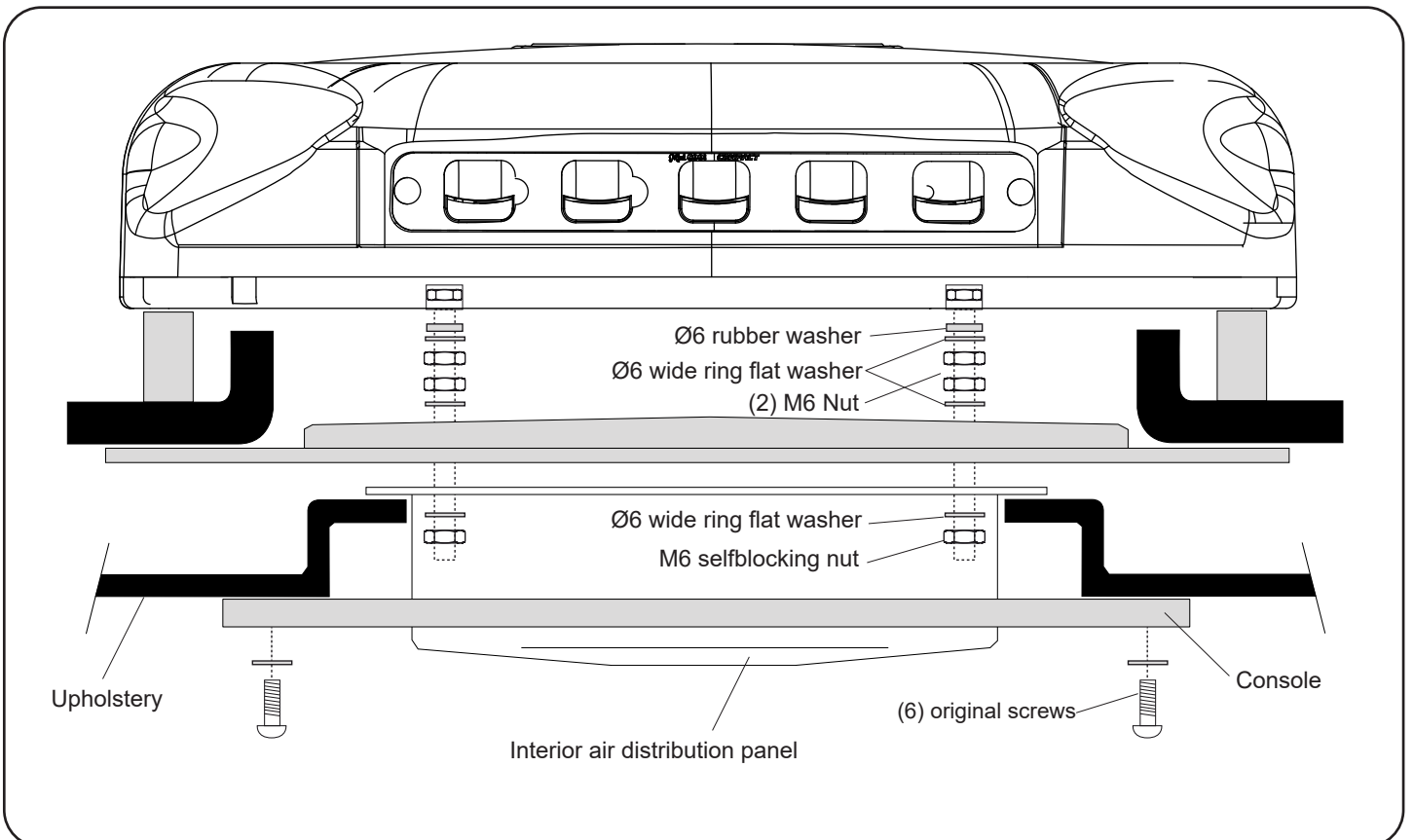

Detailed instructions on the installation of power supply cables

1 Connect the power cable to the unit's cable clamp and pass the cabling behind the input pipe.

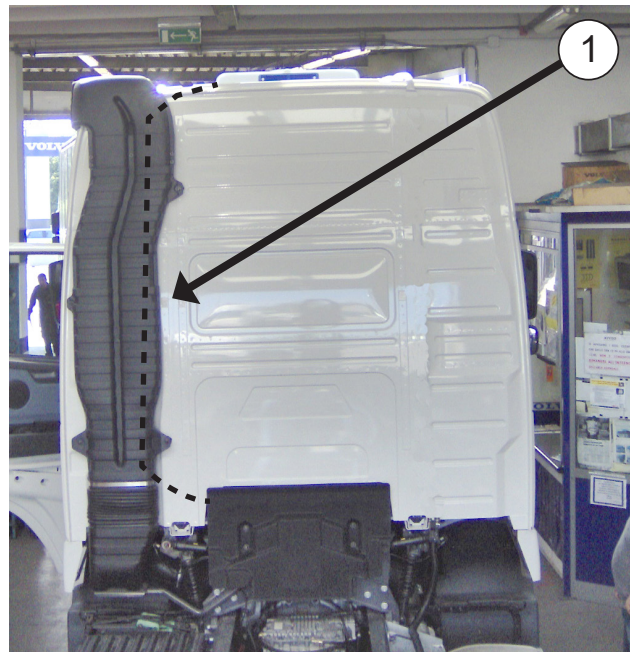
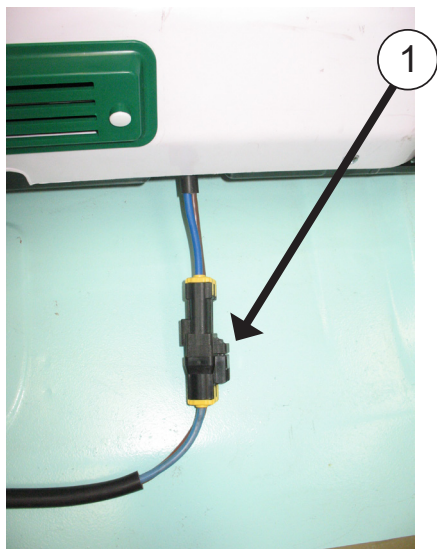

2 Take down the cabin and pass the cable through the indicated place to the positive connection point on the front of the cabin.

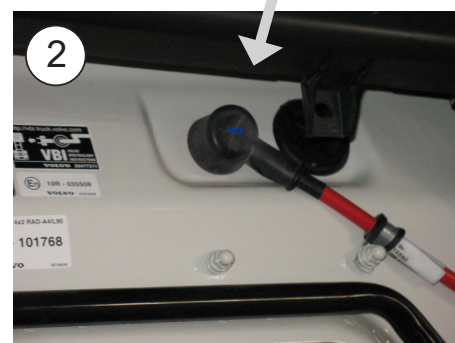
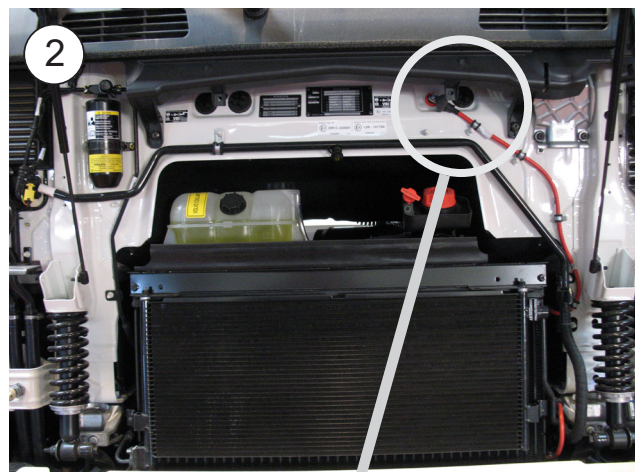
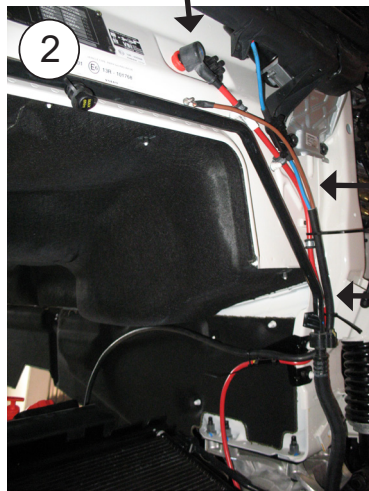
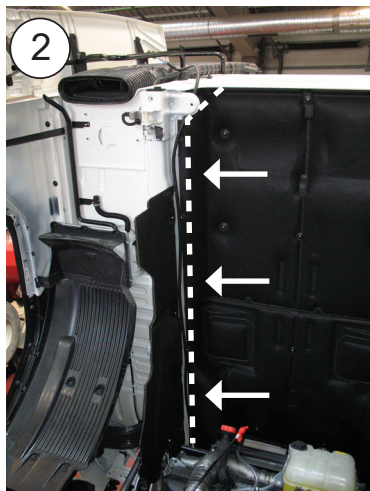

3 Remove the M6 nut and the M8 connection nut (+), and connect the power cable as indicated.

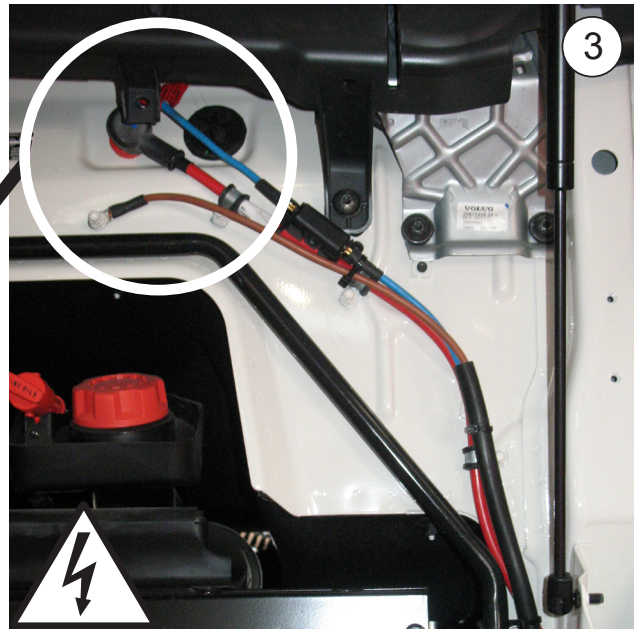
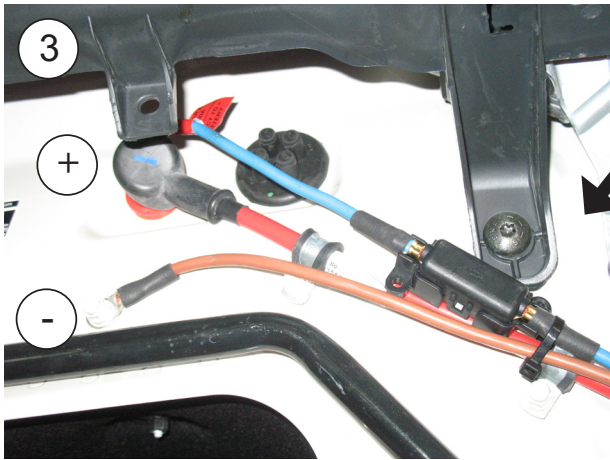

4 Secure the cabling to the original cable with flanges.



5 In the lower section, secure to the original studs with fasteners.

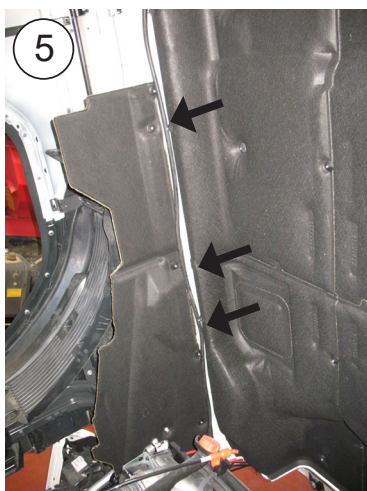

6 Take down the cabin and leave it in on position, placing any excess cabling behind the input pipe.

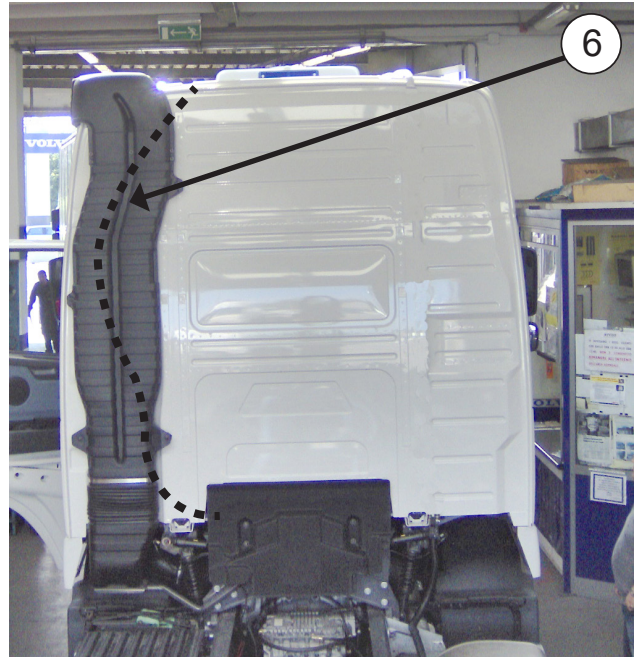

 If the vehicle has a spoiler fitted, the modifications shown here must be carried out before placing it back in its original position.

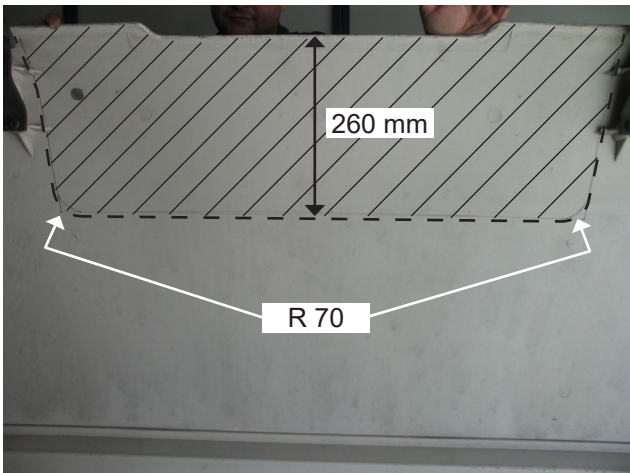

View inside the spoiler. Make cuts at the indicated points.



Electric wiring

IMPORTANT WARNING!

Take care not to invert the polarities when connecting the equipment to the battery. If this happens, the plate does not come on and the unit does not work.

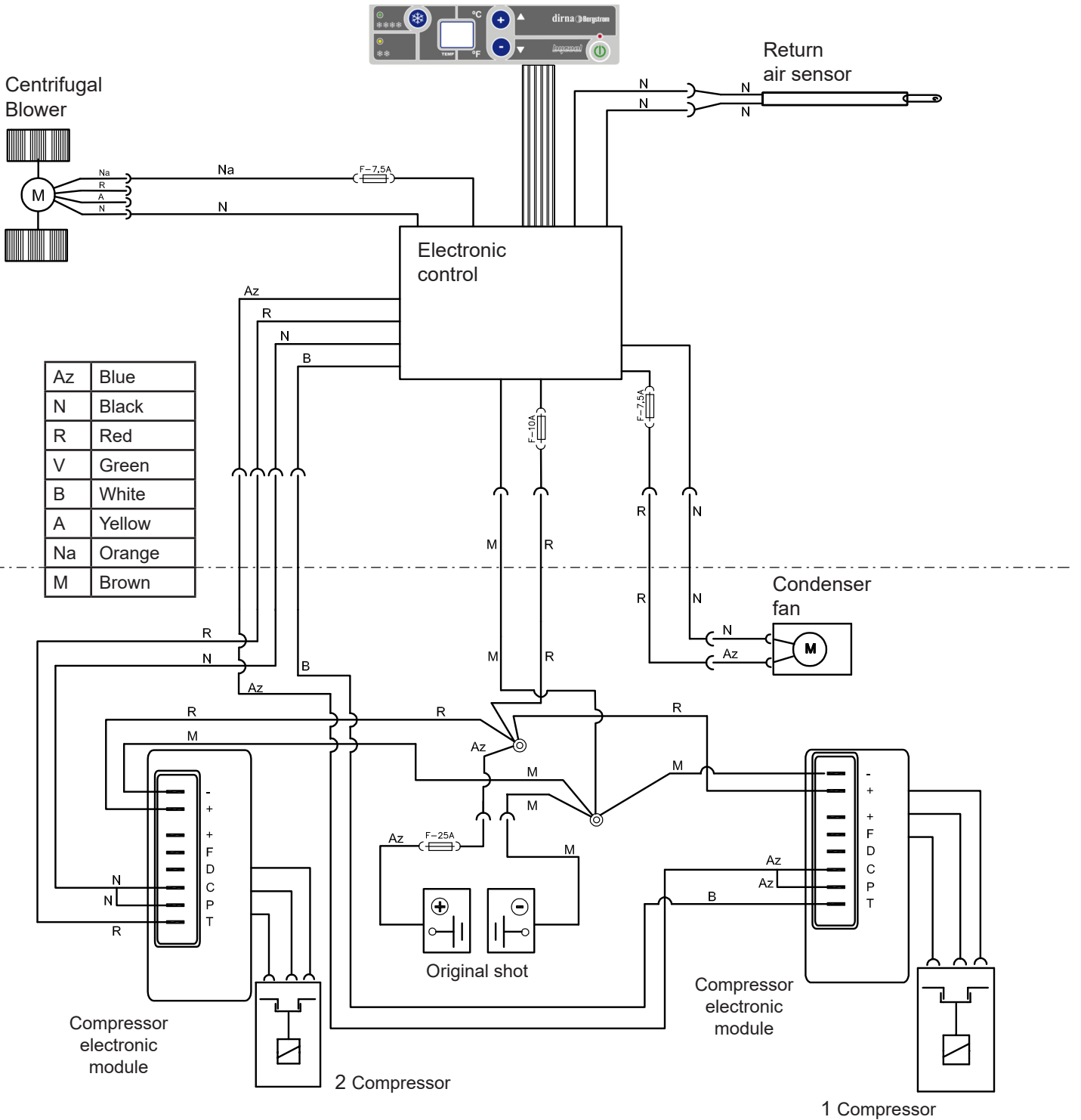

Recommandations Pour Le Montage

- Avant de commencer le montage de l'appareil, prière de lire les instructions et de les suivre attentivement.
- Utiliser les outils convenant à chaque opération.

Electricity

- Déconnecter la clé de contact.
- Déconnecter la batterie avant de commencer le montage.
- Vérifier le câblage des composants électriques et leur correcte installation.

Attention

Si pendant le montage l'équipement est incliné, il faudra attendre au moins 60 minutes avant de le mettre en marche une fois qu'il aura été remis sur sa position horizontale.

Attention

Lors de l'installation de l'appareil d'air conditionné sur le toit, il faudra protéger la partie supérieure de la cabine avec un linge ou une couverture de protection afin d'éviter les éventuelles égratignures.

Durant l'installation du **Compact**, tenir compte du fait que normalement les cabines pourvues d'écouille possède une structure suffisamment solide pour supporter le poids de l'appareil. Cependant, si ce n'est pas le cas et qu'il est nécessaire de découper le toit ou même si disposant d'écouille, la structure n'est pas suffisamment rigide (si elle était en fibre, plastique, etc.) il appartiendra à l'installateur de décider s'il faut renforcer le toit pour éviter toute déformation, rupture ou voie d'eau, etc., et prendre les mesures nécessaires à cet effet.

Outils

Jeu de clés Torx

Jeu de clés Allen

Clé fixe 10, 13, 14

Ciseaux

Mètre

Documentation included

Instructions de montage	220.AA6.0410
Guide de l'utilisateur	220.AA6.0170
Solution des problèmes	220.AA6.0013
Garantie	220.AA1.0017

Symbologie



Fragile





Attention aux coupures !



Risque électrique

Garantie

 L'installateur devra posséder la formation pertinente en air conditionné sur véhicules.

 **dirna Bergstrom, s.l.**, ne sera pas responsable des dommages ou des bris dérivés d'une installation ou d'une manipulation incorrecte ni des modifications réalisées sans autorisation expresse par écrit.

 **Appareil pré-chargé de gaz réfrigérant. (Ne pas manipuler le circuit de gaz réfrigérant).**

 Voir **la procédure de garantie** du produit au **Diagnostic de problèmes**.

 Voir le **Guide de l'Usager** de l'appareil pour le fonctionnement correcte de la télécommande et du tableau de commande.

 Après l'installation, vous devez fournir à l'utilisateur: Manuel d'utilisation, garantie et diagnostic de pannes.

 Avant de commencer le montage, monter la grille d'entrée d'air frontale.



1 Démontez le couvercle de l'écouille, les éléments de fixations et les remettez au client.

 Si le véhicule incorpore un spoiler, il est nécessaire de le démonter pour commencer l'installation de l'équipement.

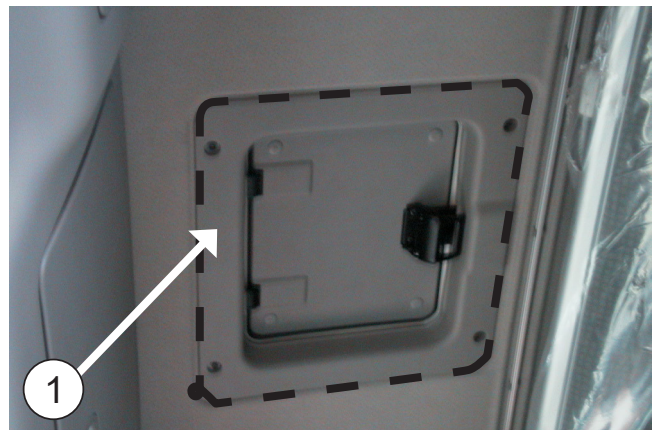
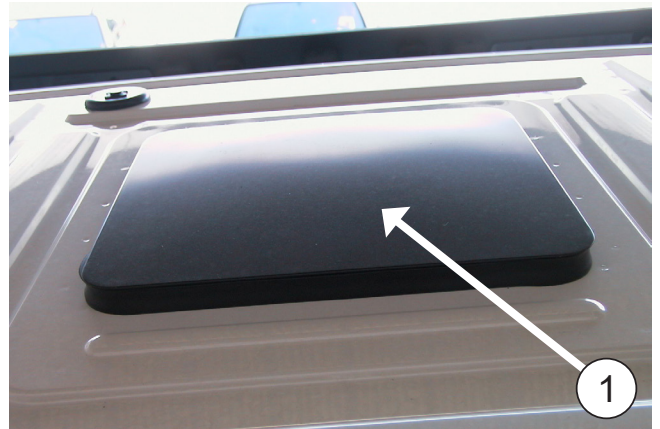

2 Coller le joint autour du creux de l'écouille en respectant la mesure indiquée pour que la recirculation se maintienne dans le joint EPDM.

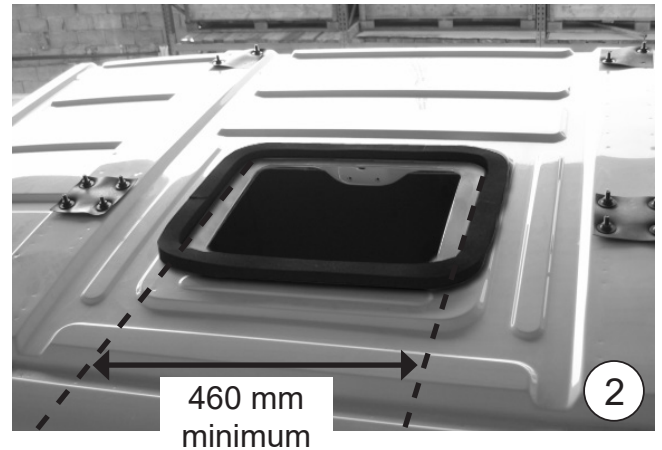

2a Détail du placement du Joint.



COMMENT COUPER LE JOINT EPDM POUR EVITER LES FILTRATIONS DANS LA CABINE

- A-** Coller le joint en maintenant une protection en papier de 100 mm de chaque côté.
- B-** Retirer les deux morceaux de papier.
- C-** Coller en faisant pression sur les deux extrémités.

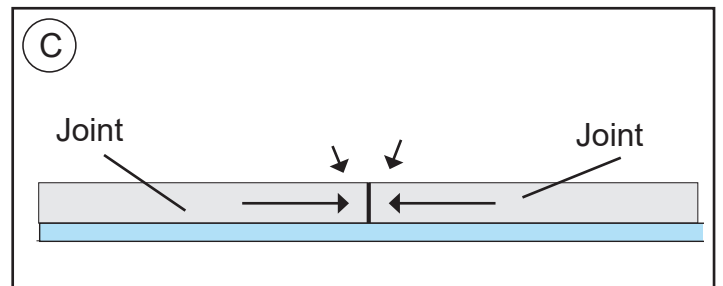
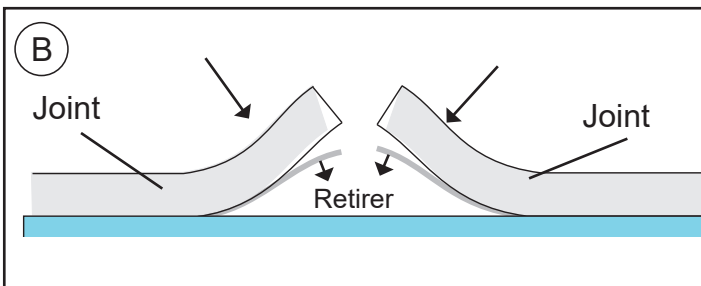
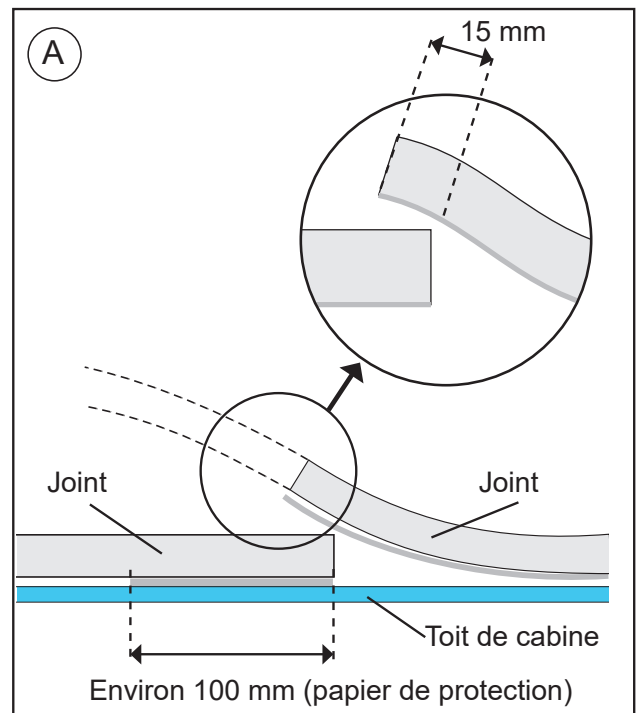

3 EXTERIEUR CABINE:

Positionner le **Compact** dans l'espace prévu.

ATTENTION ! Avant de placer l'équipement sur le creux de l'écouille, vérifier que les sorties d'écoulement ne soient pas bouchées par le joint EPDM.

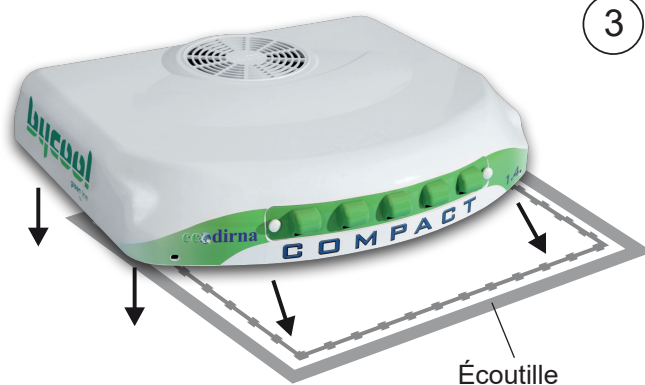

4 INTÉRIEUR CABINE:

Visser 5 mm environ (4) tubes 6/100x120 dans la base du **Compact**.

Du point 5 au point 10, les opérations effectuées se feront pour rendre le Compact centré, pour éviter les serrages complets.

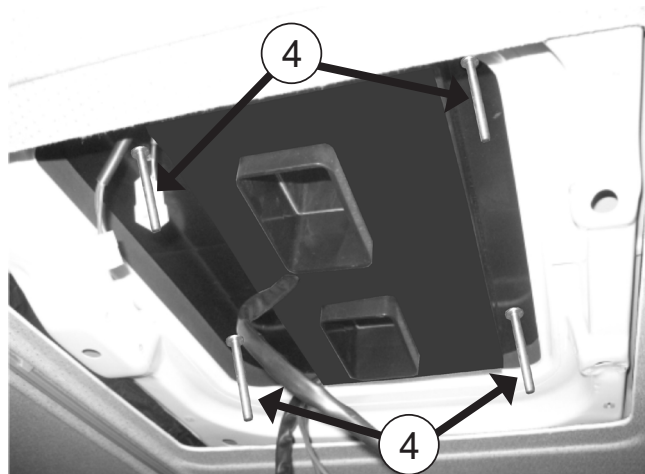

5 Placer (1) rondelle Ø 6 en caoutchouc, (1) rondelle plate Ø 6 aile large, (2) écrou M6 et (1) rondelle plate Ø 6 aile large, dans chacun des tubes antérieurs.

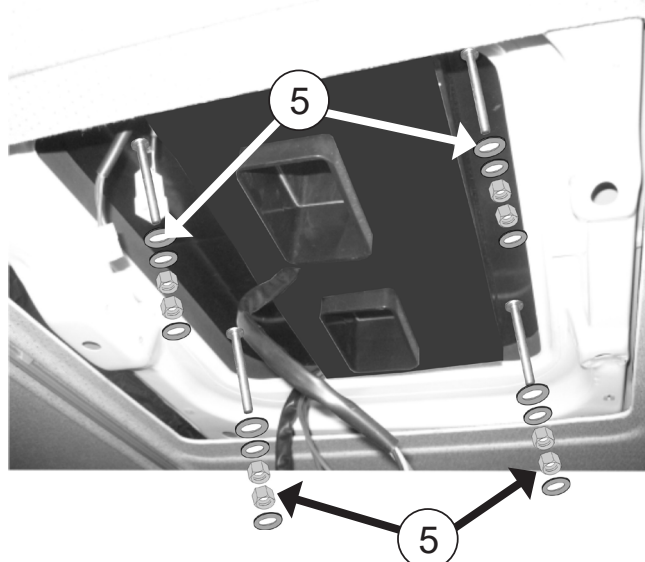

- 5a** Positionner (2) supports fixation sur les tubes entre la tapiserie et la structure métallique de la cabine.

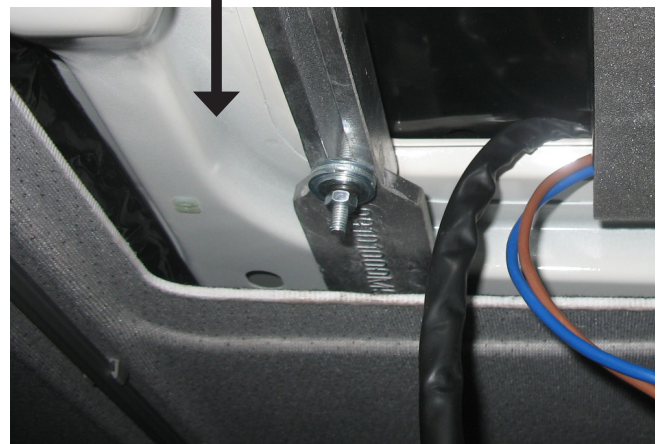
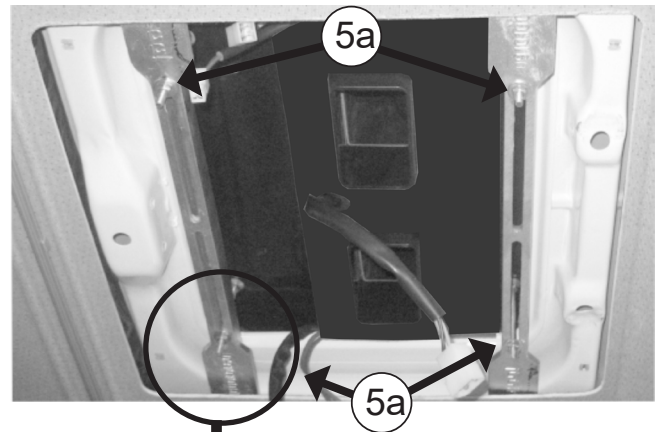

- 6** Placer les canalisations a mousse en restanta la part plus molle sous la base d'équipement.



- 7** Connecter les (2) boîtiers à 4 voies, les (2 boîtiers à 2 voies et connecter le câblage d'alimentation au boîtier à 2 voies en "T" entre l'équipement et le panneau intérieur de distribution d'air.

ATTENTION : il est très important de ne pas inverser les couleurs de la boîte à 2 voies du ventilateur du condenseur (boîte avec câbles R et N).

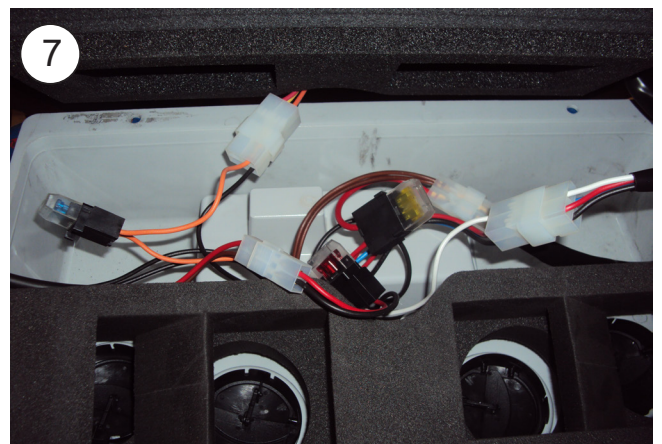

8 Introduire les câblages dans le creux existant (H) du panneau intérieur de distribution d'air pour ne pas interférer dans le réglage des canalisateurs avec la base de l'équipement.

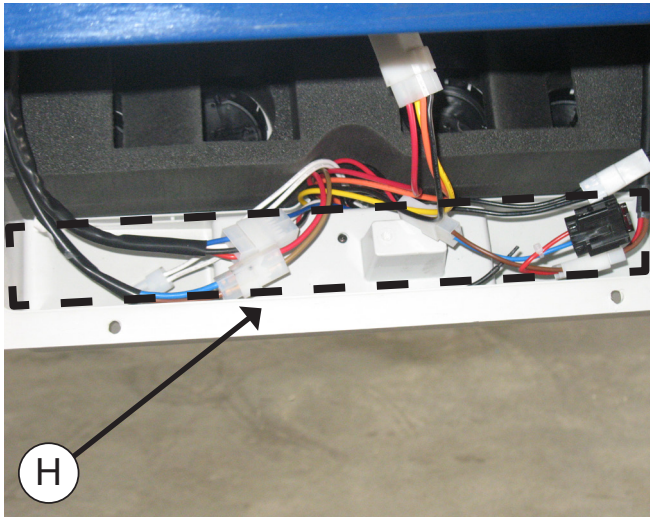

9 Présenter l'ensemble du panneau intérieur de distribution d'air sur les supports de fixation avec (4) rondelles plates de 6 mm, en le fixant avec (4) écrous M6 autoblocants et visser sans serrer.

Important: Les canalisateurs doivent faire butée contre la mousse pour éviter les fuites d'air.



10 Présenter la console avec vis originales et centrer sur le **Compact** dans la meilleure position pour faire coïncider les vis originales avec leurs positions.



- 11** Une fois ces opérations effectuées, démonter la console, en serrant les écrous (A) jusqu'à ce que le joint EPDM se comprime entre 3 et 5 mm environ, puis serrer les écrous à la base du Compact (B) et les écrous supérieurs du support C. Schéma A.

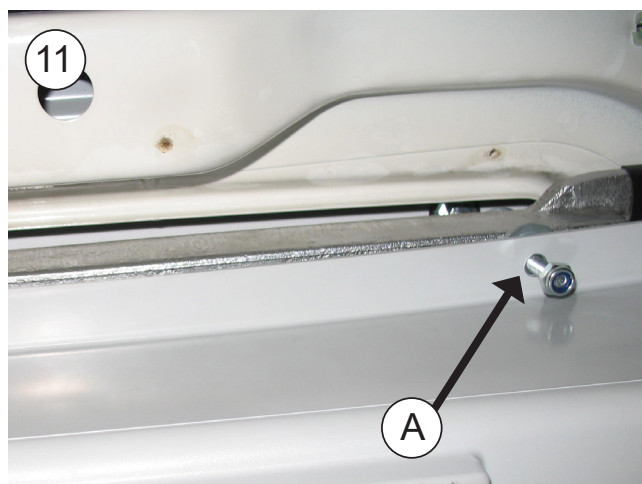

! **Important:** Pour éviter de possibles filtrations d'eau, assurer le serrage du joint avec la base du Compact – Paire de serrage 1.3 à 1.8 Kg Tel qu'indiqué sur le Schéma A.

Serrer écrous "A" jusqu'au serrage du joint entre 3 et 5 mm. Puis serrer écrous "B" y "C".

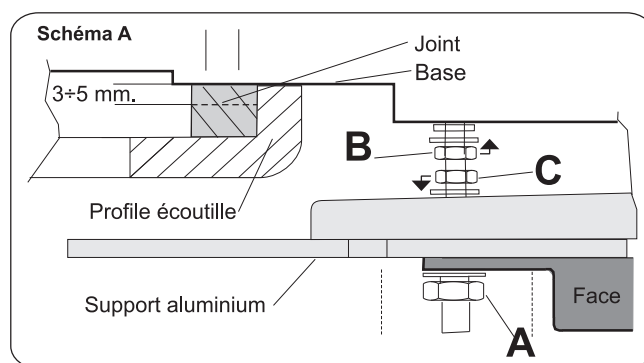

- 12** Monter de nouveau la console avec les vis originales.

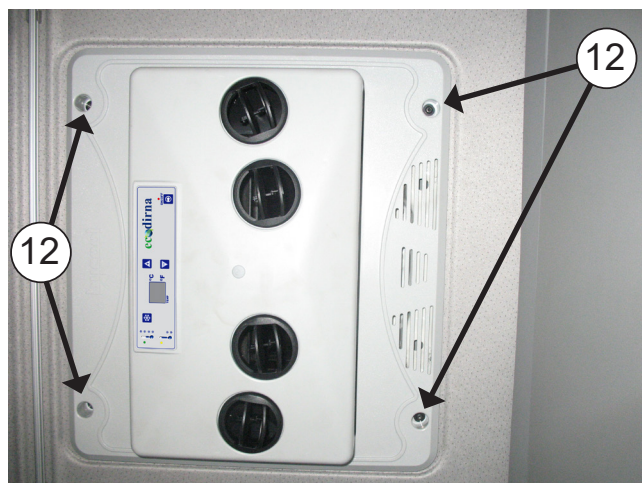

Vue en éclaté jusqu'à la fixation des supports

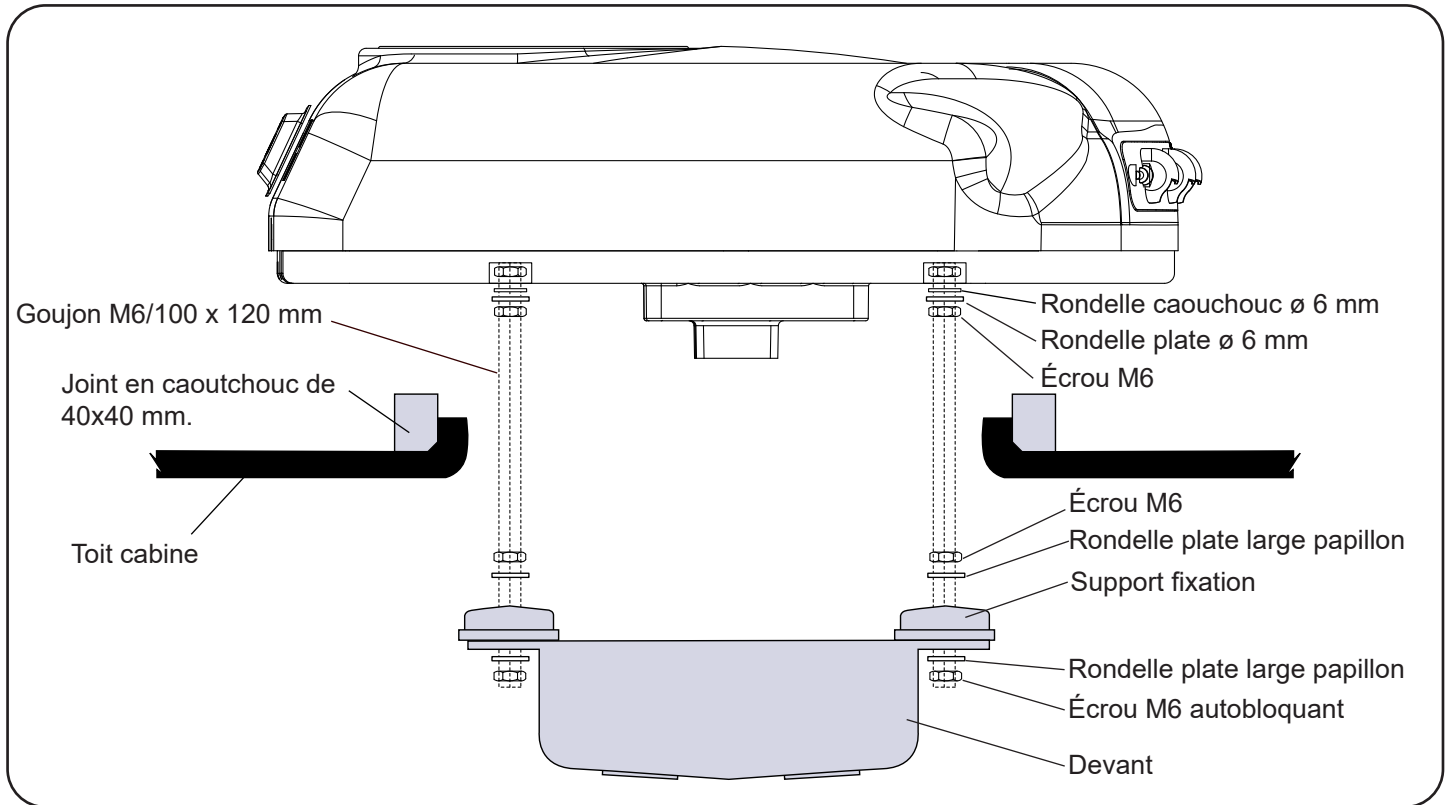

Vue en éclaté jusqu'à la fixation de la console

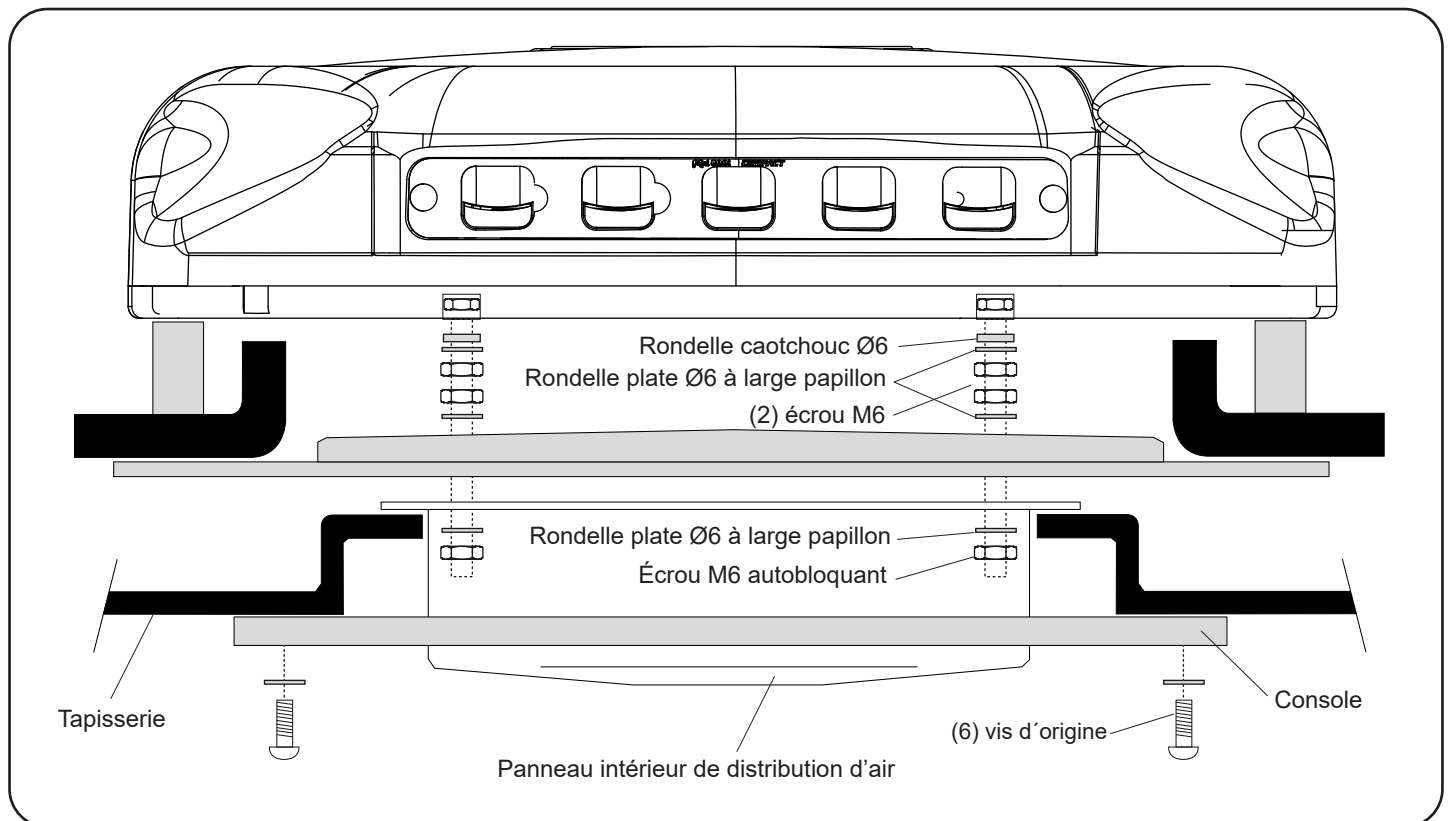

Instructions détaillées sur l'installation du câblage d'alimentation

1 Connecter la borne du câble d'alimentation à la borne de l'équipement et passer le câblage derrière le tuyau d'admission.

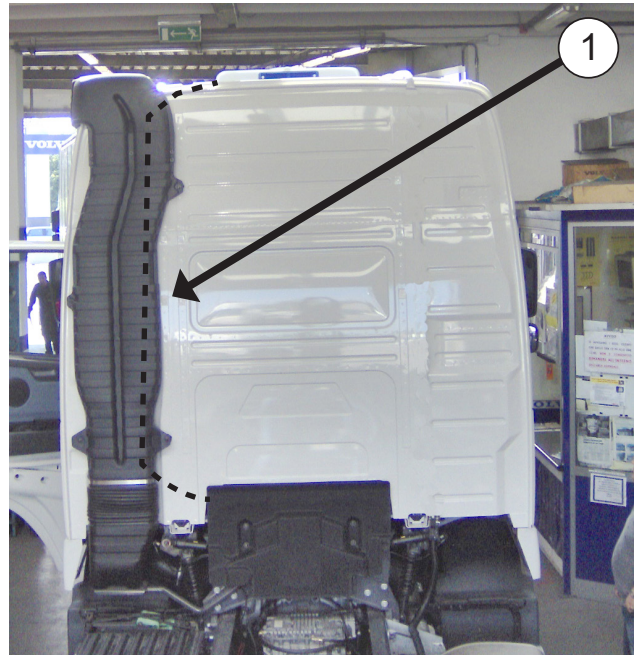
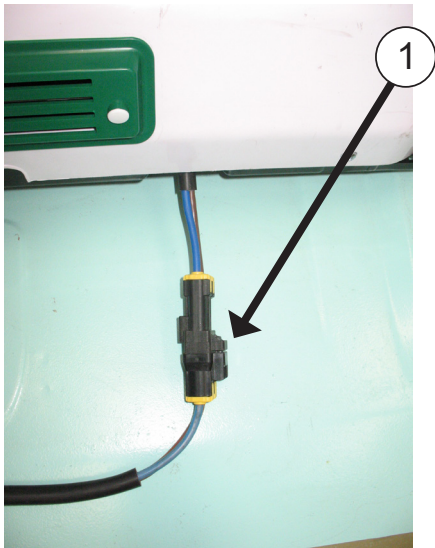

2 Incliner la cabine et mener le câble à travers le lieu indiqué jusqu'à la prise de positif située sur la partie avant de la cabine.

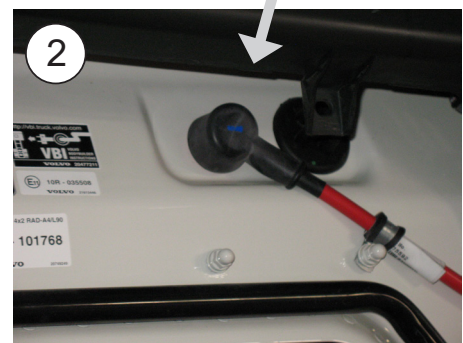
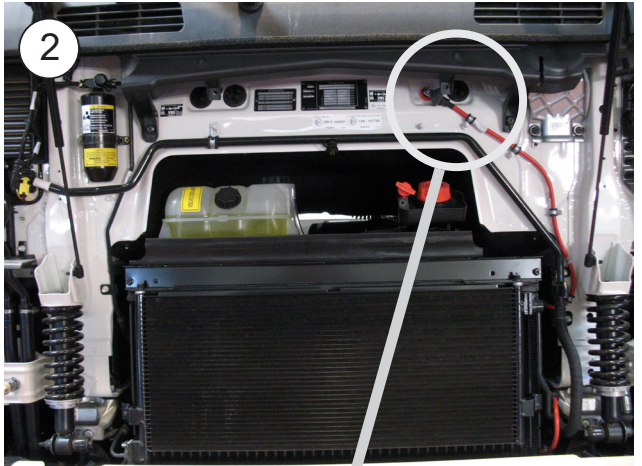
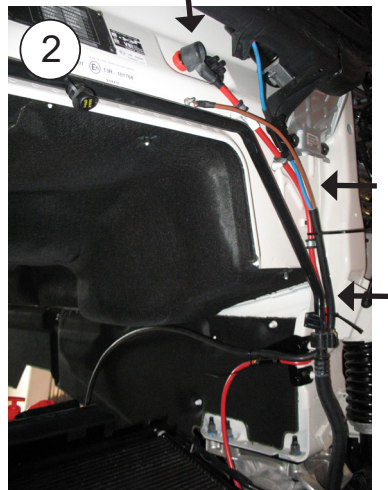
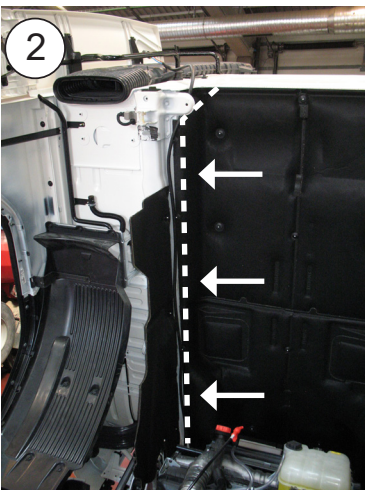

3 Démontez l'écrou M6 et l'écrou M8 de la prise (+) et connectez le câblage d'alimentation comme cela est indiqué.

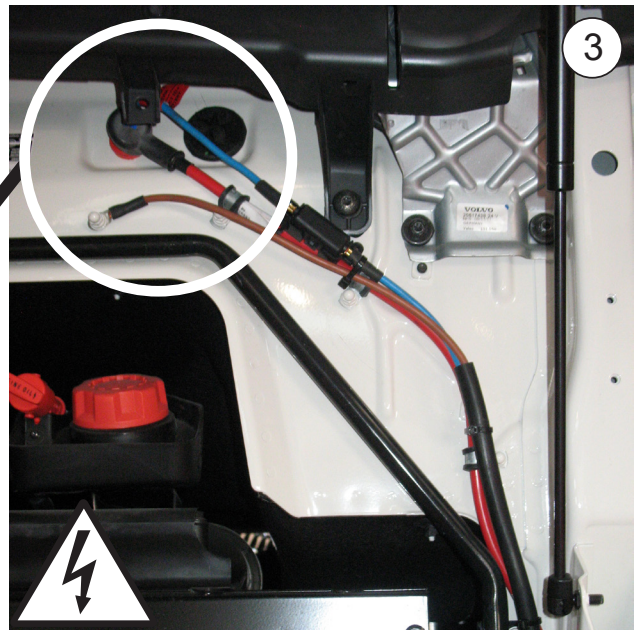
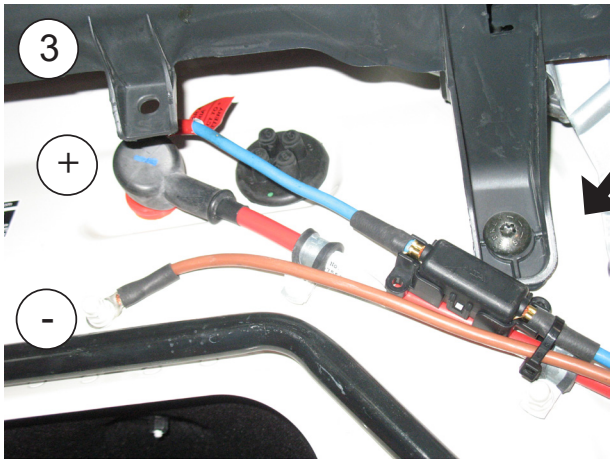

4 Fixer le câblage avec des brides au câble d'origine.

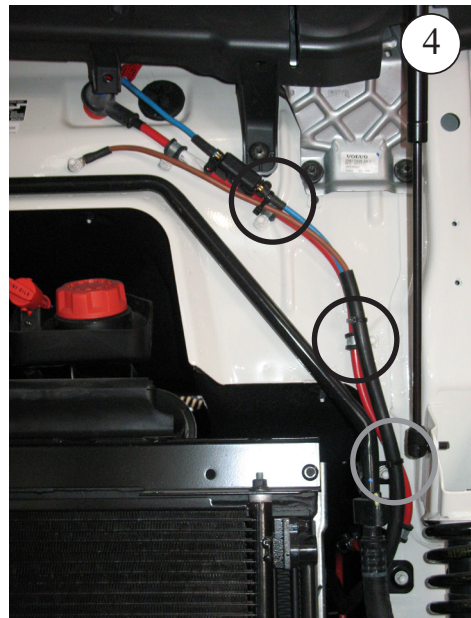

5 Sur la partie inférieure, fixer avec des colliers aux vis sans tête d'origine.

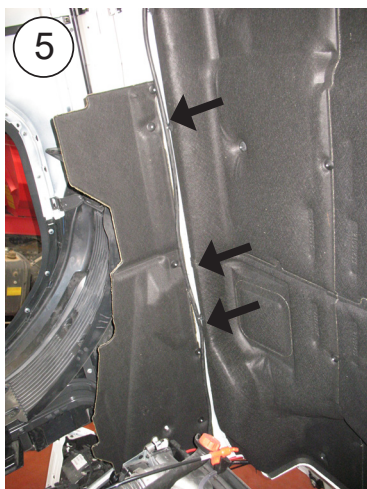

6 Incliner la cabine et laisser sur la position de marche. Placer le câblage restant derrière le tuyau d'admission.

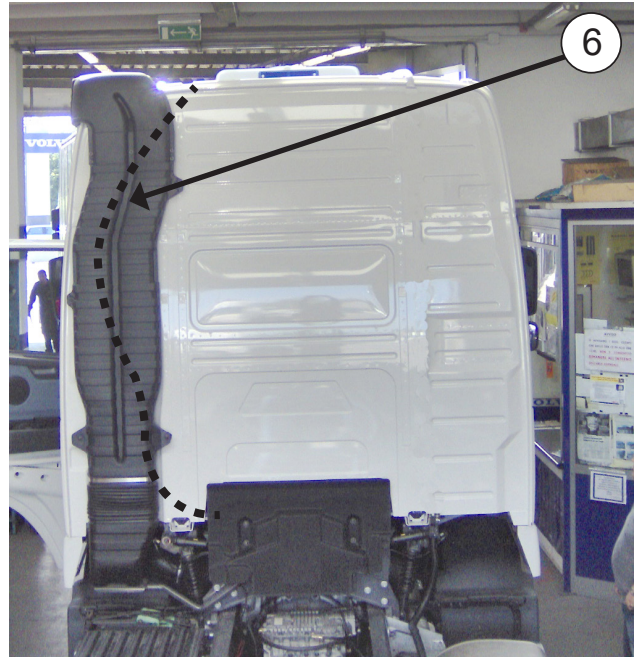

 Si le véhicule incorpore un spoiler, il est nécessaire d'effectuer les modifications indiquées avant de réinstaller le spoiler à sa position d'origine.

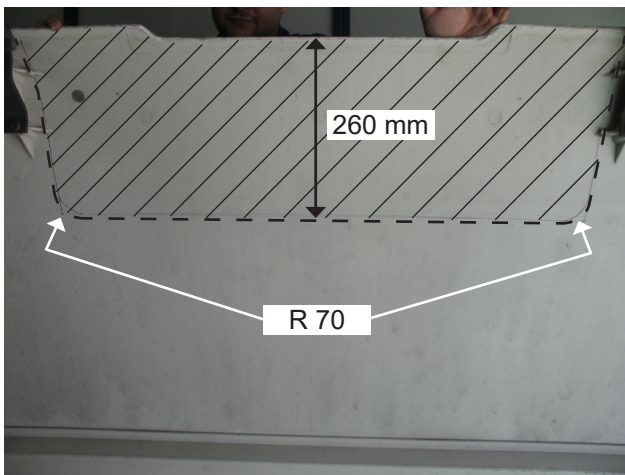

Vue à travers la partie intérieure du spoiler. Couper en fonction des mesures indiquées.



Câblage électrique

AVERTISSEMENT IMPORTANT!

Attention de ne pas inverser les polarités au moment de connecter l'équipement à la batterie. Si cela se produisait, la plaque de commande ne s'allumerait pas et l'équipement ne fonctionnerait pas.

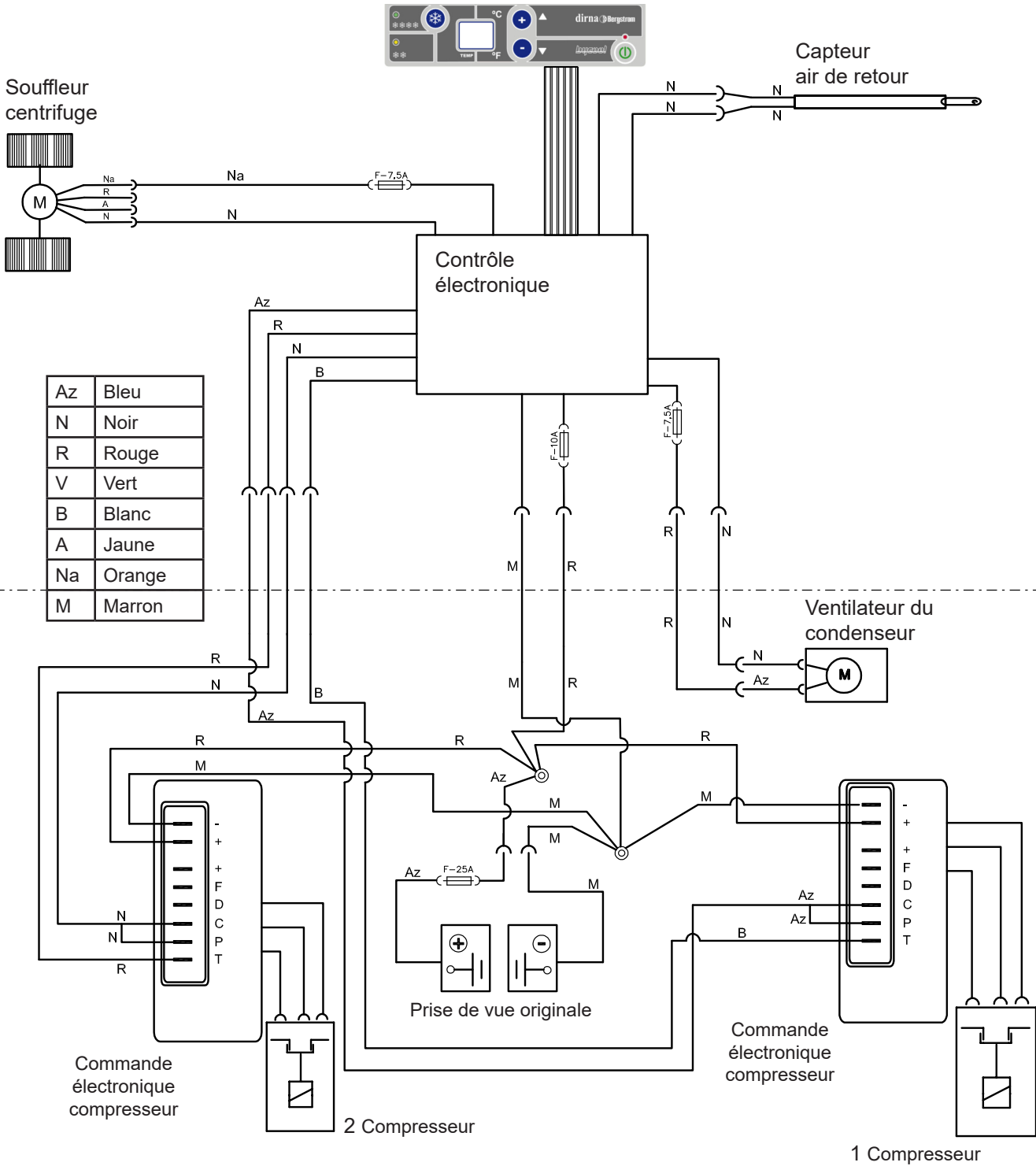

Empfehlungen Zur montage

- Vor und während der Montage bitte diese Anweisungen lesen und beachten.
- Benutzen Sie für jeden Arbeitsschritt die geeigneten Werkzeuge.

Elektrizität

- Zündschlüssel abziehen.
- Vor Montagebeginn die Batterie abklemmen.
- Den ordnungsgemäßen Anschluss und die korrekte Installation der Elektrokomponenten überprüfen.



Achtung

Sollte sich das Gerät während der Montage neigen, muss man mindestens 60 Minuten warten, nachdem es wieder in die horizontale Lage gebracht wurde, um es wieder einzuschalten.



Achtung

Wird die Klimaanlage im Kabinendach installiert, muss der obere Teil der Kabine mit einem Tuch oder einer Decke gegen eventuelle Kratzer geschützt werden. Bei der Installation der **Compact** auf dem Kabinendach muss darauf geachtet werden, dass mit Luken ausgestattete Kabinen über eine ausreichend stabile Struktur verfügen, um das Gewicht des Geräts stand zu halten. Sollte das Fahrzeug über keine Luke verfügen und sollte es notwendig sein, das Kabinendach aufzuschneiden, bzw. sollte die vorhandene Struktur nicht ausreichend stabil sein (z.B. wenn sie aus Faser, Kunststoff usw. hergestellt ist), obliegt es dem Installateur zu entscheiden, ob das Kabinendach zur Vermeidung von Verformungen, Brüchen, undichten Stellen usw. verstärkt werden muss, und die hierfür notwendigen Mittel bereit zu stellen.

Werkzeuge

Torx-Schraubenschlüssel
 Inbusschraubenschlüssel
 10er, 13er, 14er Schraubenschlüssel
 Schere
 Metermaß

Mitgelieferte unterlagen

Montageanweisungen	220.AA6.0410
Benutzerleitfaden	220.AA6.0170
Fehlerdiagnose	220.AA6.0013
Garantie	220.AA1.0017

Symbologie



Fragile



Attention aux coupures !



Risque électrique



Warnhinweise



Der Installateur muss im Bereich Fahrzeug-Klimaanlagen ausreichend geschult sein.



dirna Bergstrom, s.l. übernimmt keine Verantwortung für Schäden oder Brüche aufgrund einer nicht ordnungsgemäßen Installation oder Bedienung des Geräts oder den Austausch von Teilen bzw. Umbauten, die ohne die erforderliche schriftliche Genehmigung durchgeführt wurden.



Mit Kältemittel vorgefülltes Gerät.

(Kältemittelkreislauf nicht manipulieren).



Siehe **Garantieverfahren** des Produkts in der **Fehlerdiagnose**.



Siehe **Benutzerleitfaden** des Geräts für den ordnungsgemäßen Betrieb der Fernbedienung und des Bedienfelds.



Die folgenden Unterlagen müssen dem Benutzer nach der Installation ausgehändigt werden: **Benutzerleitfaden**, **Garantie** und **Fehlerdiagnose**.

 Vor Montabeginn vorderes Lufteintrittsgitter montieren.



1 Lukendeckel und Innenrahmen ausbauen und dem Kunden übergeben.

 Wenn das Fahrzeug einen Spoiler hat, muss dieser für die Installation des Geräts abgebaut werden.

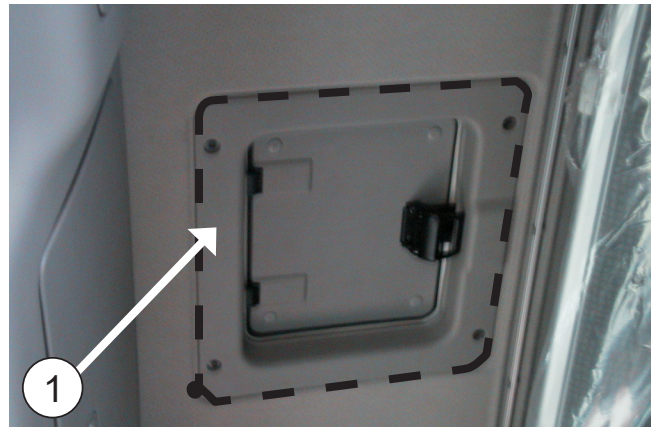
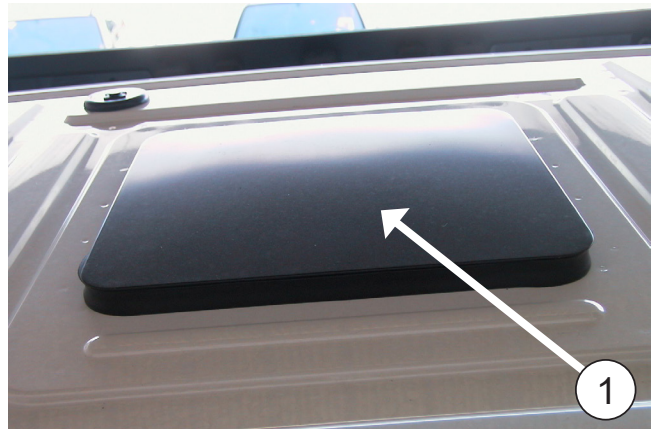

2 Dichtung unter Beachtung des angegebenen Maßes um die Lukenaussparung kleben, damit die Rückführung innerhalb der EPDM-Dichtung bleibt.

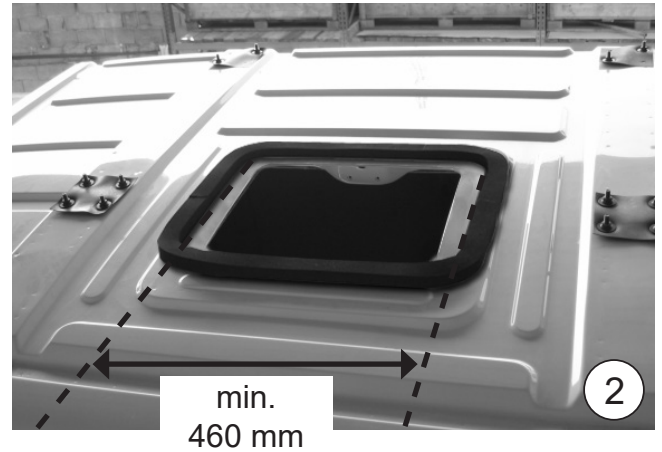

2a Einzelheit Dichtung einlegen.



WIE DIE EPDM-DICHTUNG GESCHNITTEN WIRD, UM FILTRATIONEN IN DER KABINE ZU VERMEIDEN

- A-** Dichtung aufkleben und dabei einen Papierschutz von 100 mm auf jeder Seite beibehalten.
- B-** Die zwei Papierstücke entfernen.
- C-** Unter Anpressen beider Enden aufkleben.

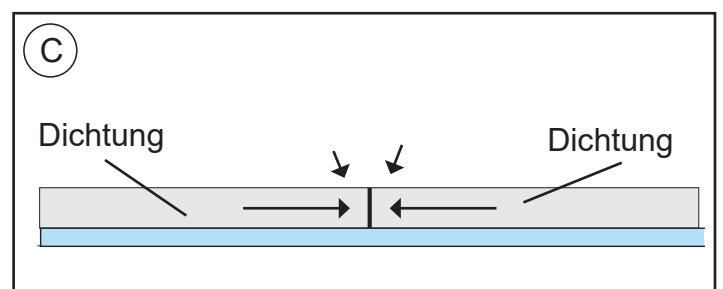
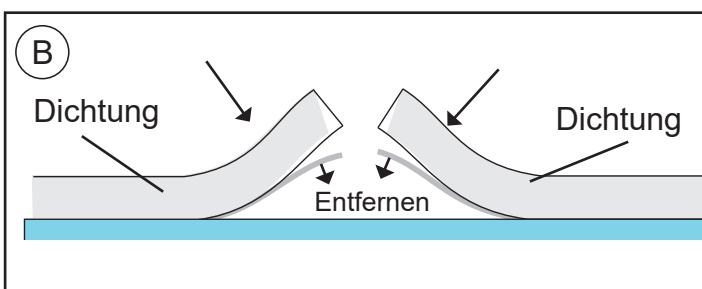
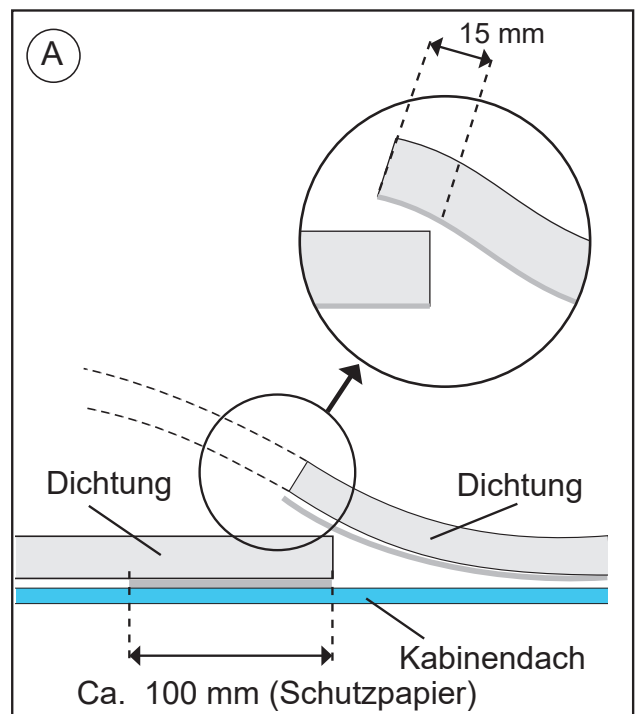

3 KABINENAUSSENSEITE:

Compact in der Öffnung positionieren.

ACHTUNG! Beim Auflegen des Geräts auf die Lukenaussparung darauf achten, dass die Ablassausgänge nicht von der EPDM-Dichtung zusammengedrückt werden.

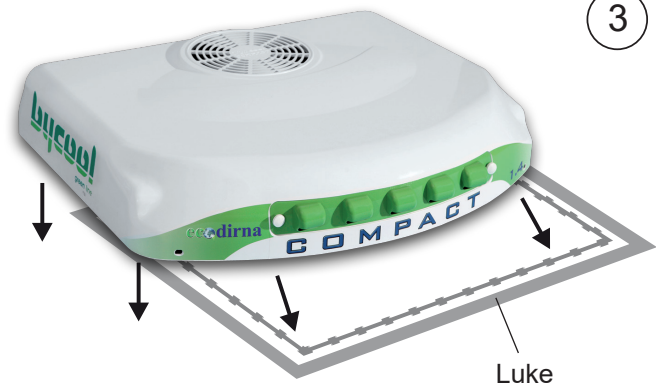

4 FAHRERHAUS INNEN:

Gewindebolzen 6/100x120 (4) ca. 5 mm in die Compactgrundplatte eindrehen.

Die Arbeitsgänge ab Punkt 5 bis Punkt 10 dienen dazu, den Compact einwandfrei zu zentrieren; deswegen werden die Befestigungen nicht ganz angezogen.

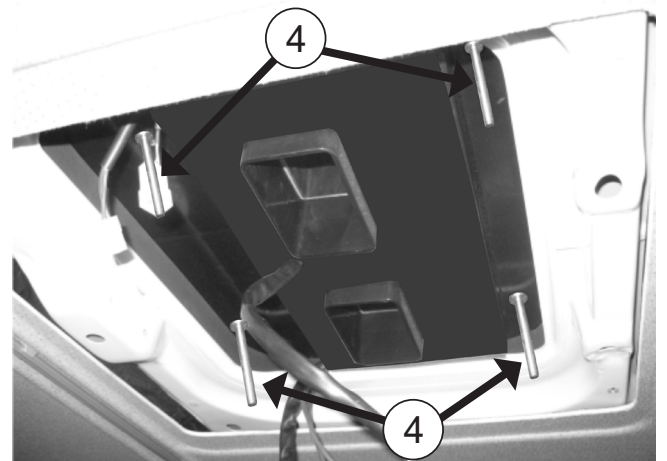

5 (1) Gummischeibe Ø 6, (1) Breitflanschflachscheibe Ø 6, (2)M6-Muttern und (1) Breitflanschflachscheibe Ø 6 unter jeden der o.g. Gewindebolzen legen.

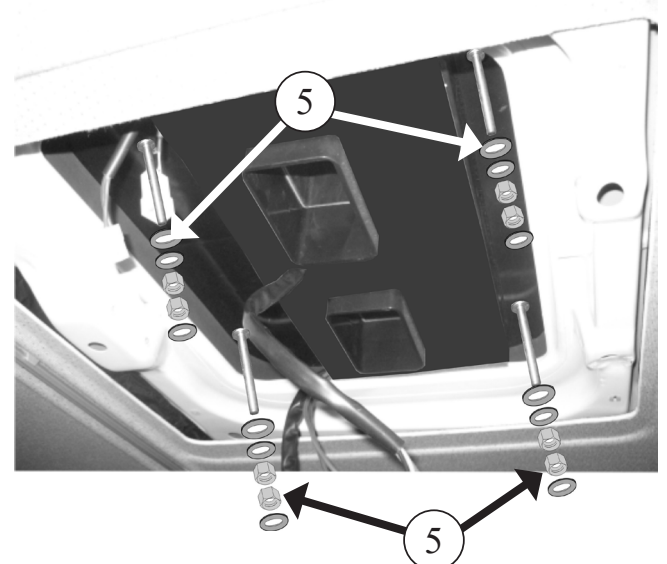

5a (2) Befestigungsstützen auf den Gewindebolzen zwischen Postering und Stahlkonstruktion des Fahrerhauses.

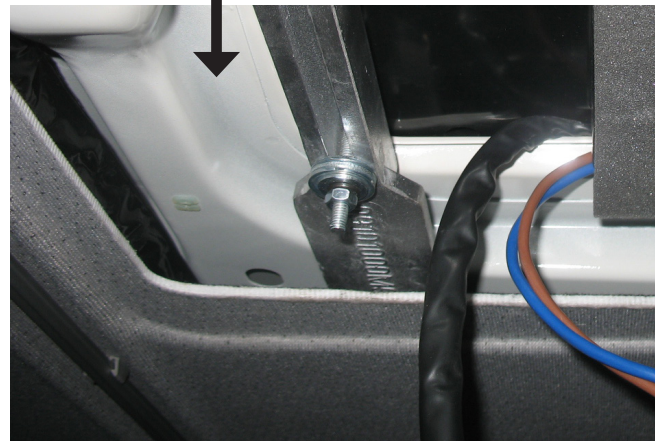
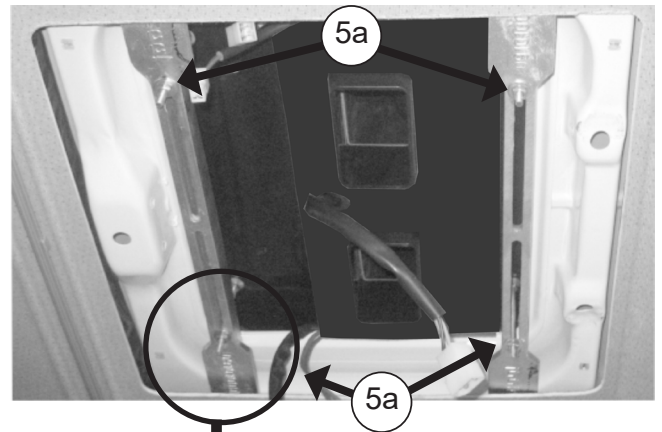

6 Montieren Sie den Schaumgummi Luftkanal mit dem weichen Teil zur Grundplatte / Basis.



7 Die (2) 4-Wege-Kästen und die (2) 2-Wege-Kästen zwischen der Anlage und der inneren Luftverteiltertafel anschließen und danach das Netzkabel am 2-Wege-Kasten als "T".

ACHTUNG: Die Farben des 2-Wege- Kastens des Elektrolüfters dürfen (Kasten mit Kabeln R und N) keinesfalls vertauscht werden!



8 Kabel in die Aussparung (H) in der inneren Luftverteiltertafel stecken, um die Justierung der Kabelführungen mit der Grundplatte der Anlage nicht zu beeinträchtigen.

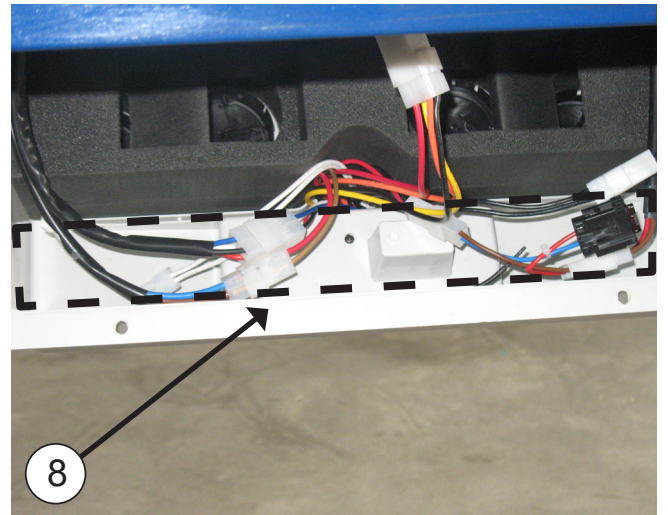

9 Innere Luftverteilungstafel mit (4) Flachscheiben 6mm auf den Befestigungshalterungen platzieren und mit (4) selbstsichernden Muttern M6 befestigen, jedoch nicht anziehen.

Die Führungsleitungen müssen auf das Schaumgummi treffen, um Luftaustritt zu unterbinden.



10 Konsole mit den Originalschrauben anlegen und auf dem Compact in der am besten geeigneten Position zentrieren, bis die Originalschrauben an ihrer Stelle liegen.



11 Nach diesen Arbeitsgängen Konsole ausbauen und Muttern (A) anziehen, bis die EPDM-Dichtung ca. 3-5 mm zusammengedrückt wird. Dann Muttern des Compact (B) und die oberen Muttern der Stürze C anziehen. Schemazeichnung A.

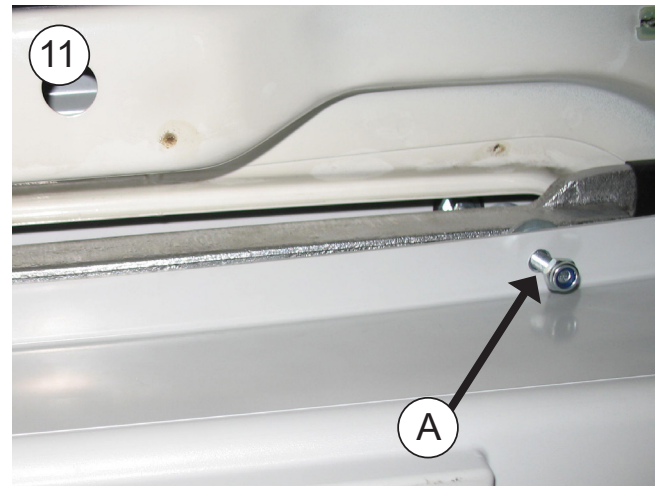

Wichtiger Hinweis: Um möglichen Einsickerungen von Wasser entgegenzuwirken, Befestigung der Dichtung auf der Compact-Grundplatte sicher. - Anzugsmoment 1.3 - 1.8 kg, wie auf Schemazeichnung A dargestellt Mutter "A" bis zum Dichtungsanzug zwischen 3 und 5 mm anziehen; anschließend Muttern "B" und "C" anziehen.

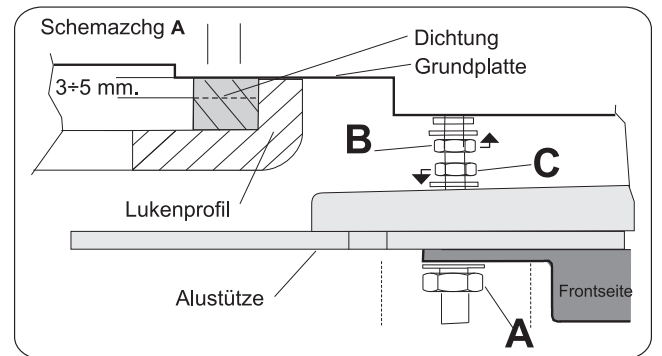

12 Konsole mit den Originalschrauben wieder einbauen.

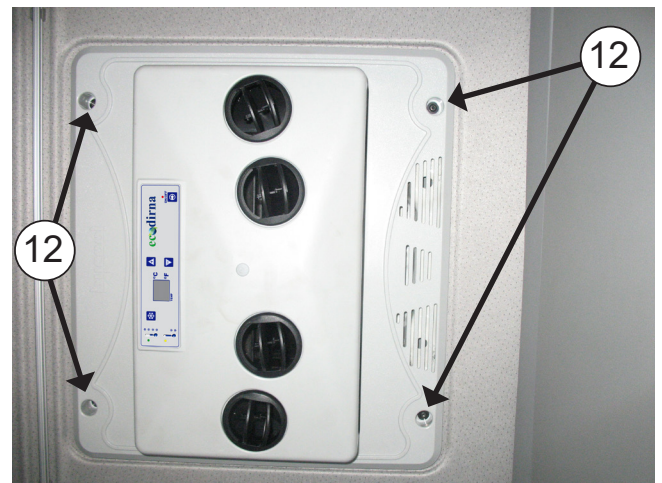

Explosionszeichnung bis zur befestigung der halter

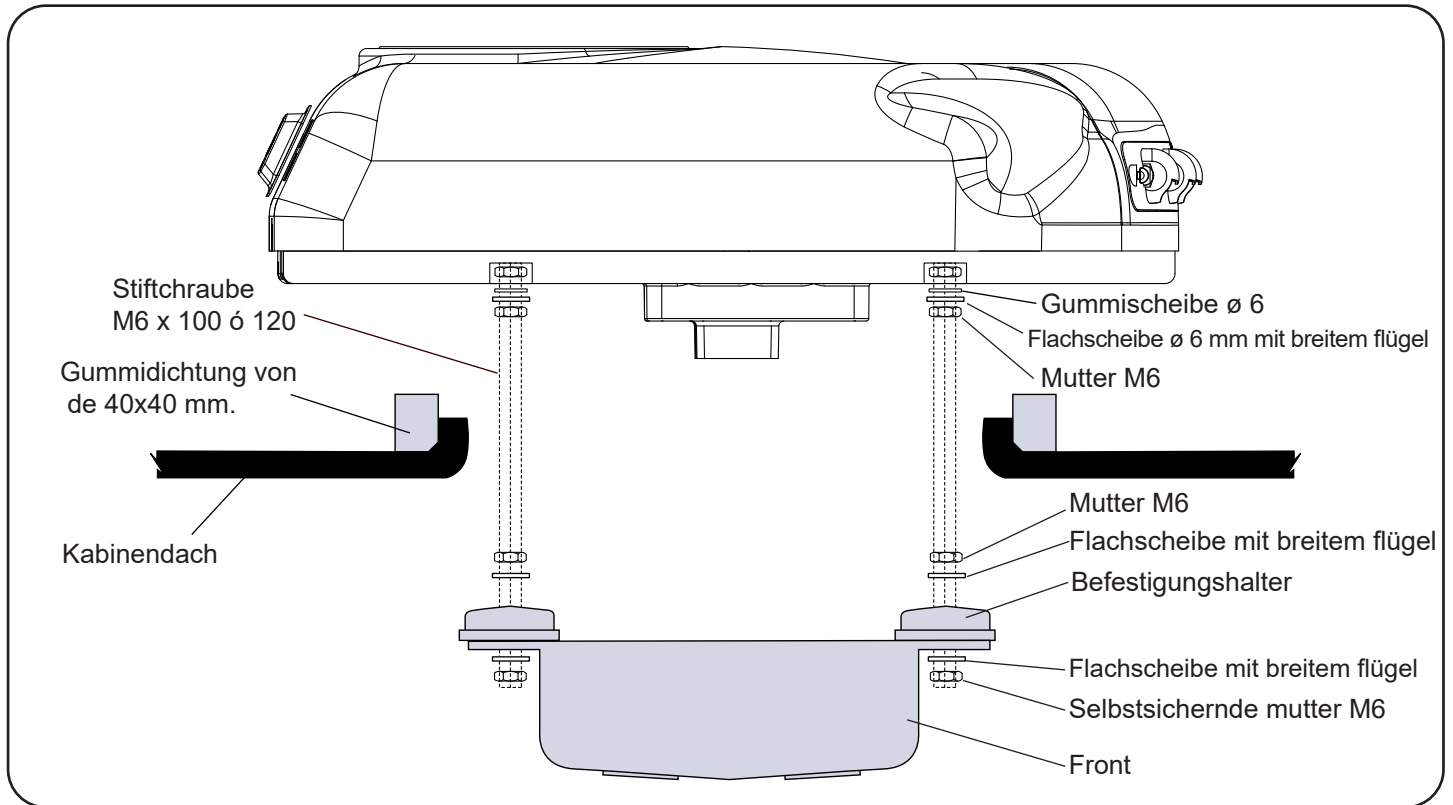

Explosionszeichnung bis zur befestigung der konsole

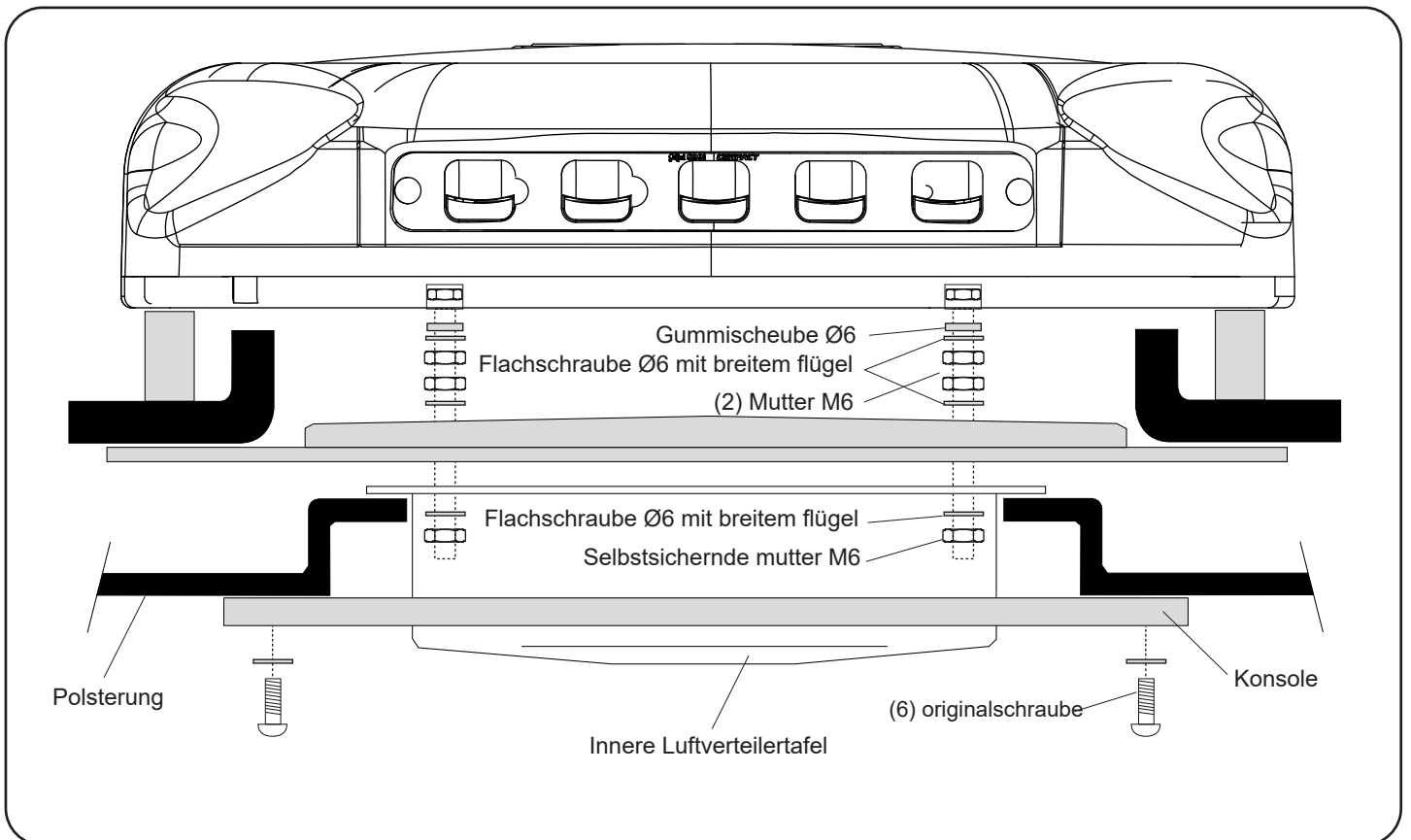

Detallierte Anleitung für die Installation des Speisekabels

- 1** Speisekabelklemme an die Geräteklemme anschließen und das Kabel hinter der Zuführleitung durchführen.

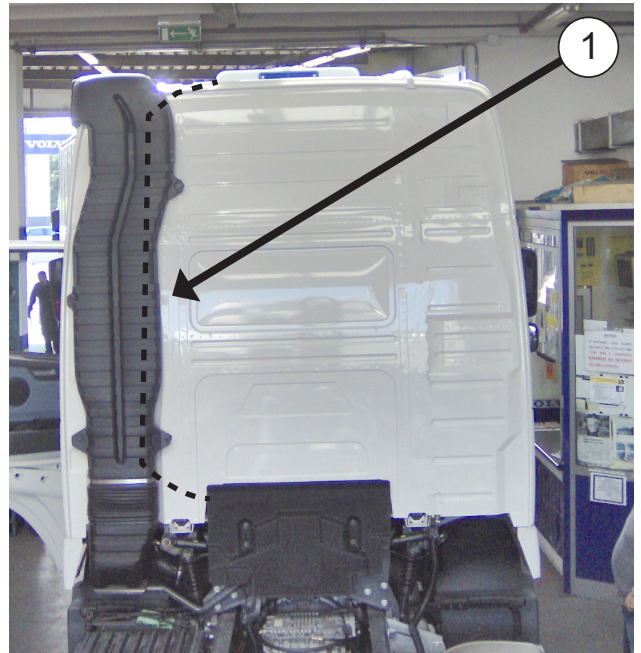
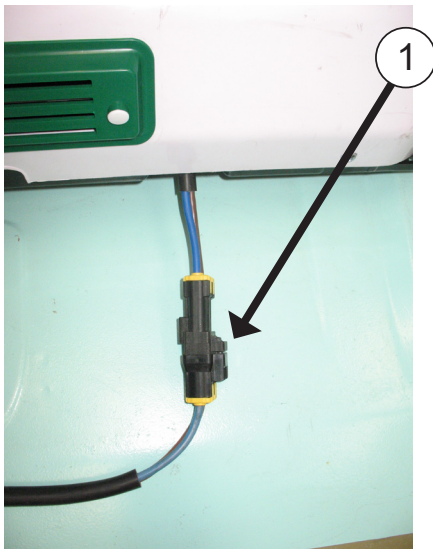

- 2** Kabine herunterklappen und das Kabel an der gezeigten Stelle bis zum Positivanschluss an der Vorderseite der Kabine entlang führen.

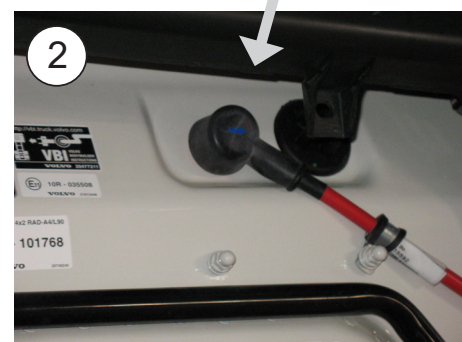
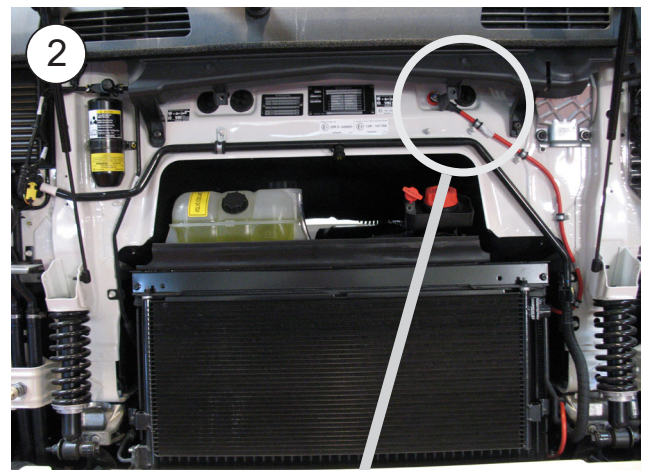
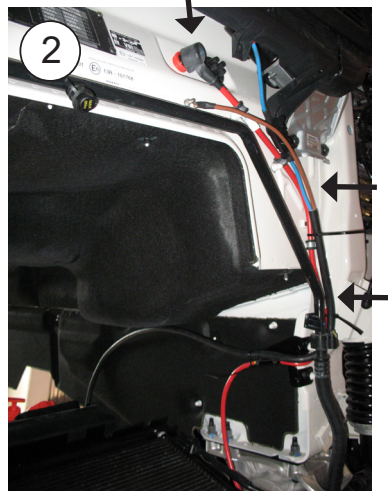
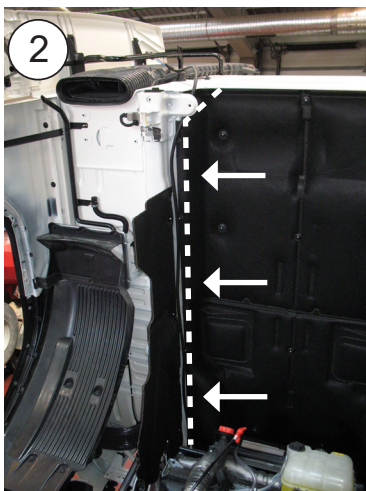

3 Mutter M6 und Mutter M8 des Positivanschlusses (+) abnehmen und Speisekabel wie gezeigt anschließen.

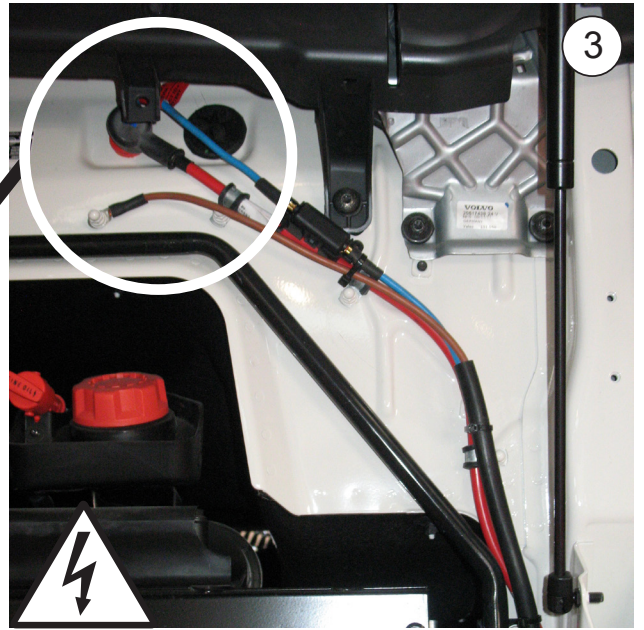
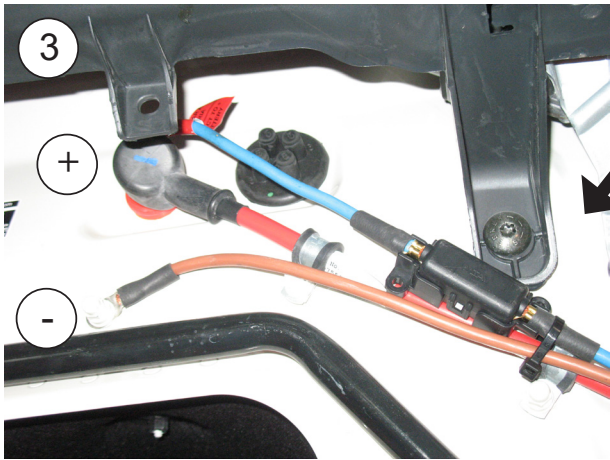

4 Kabel mit Kabelklemmen am Originalkabel befestigen.



5 An der Unterseite mit Schellen an Original-Stiftschrauben befestigen.



6 Kabine herunterklappen und in Fahrtrichtung lassen, überschüssiges Kabel hinter die Zuführleitung stecken.

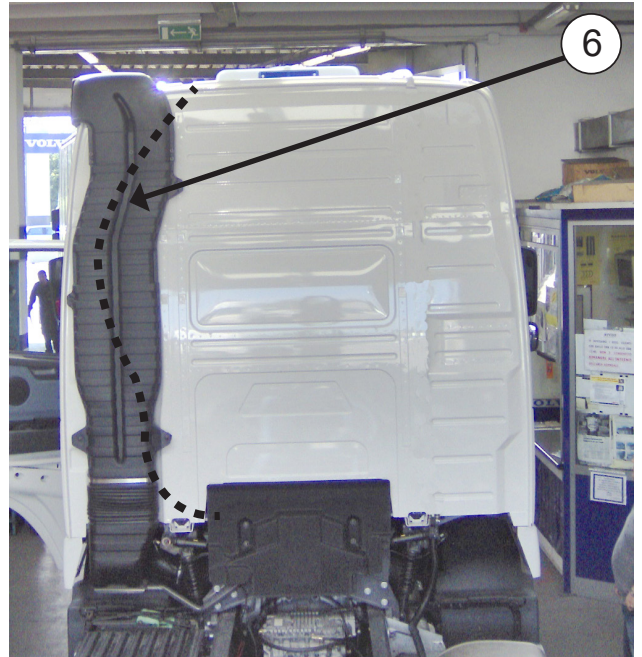

 Wenn das Fahrzeug einen Spoiler hat, müssen die angegebenen Umbauten vorgenommen werden, bevor der Spoiler wieder an seinem ursprünglichen Platz angebracht wird.

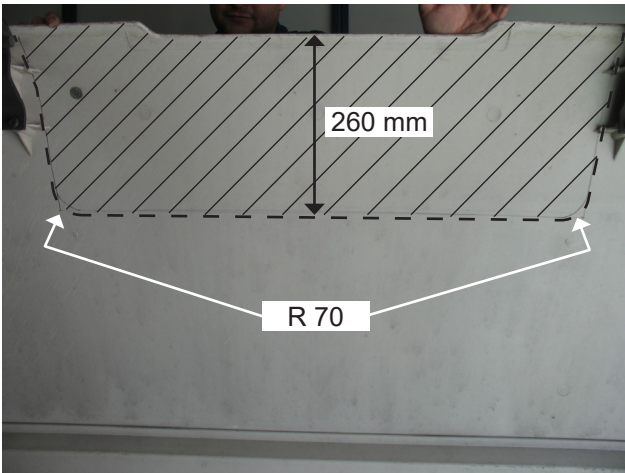

Innenansicht des Spoilers. Schnitt gemäß den angegebenen Maßen durchführen.



Elektrische Verkabelung

WICHTIGER WARHNHINWEIS!

Achten Sie darauf, die Polaritäten beim Anschluss der Anlage an die Batterie nicht zu vertauschen. Ist dies der Fall, schaltet sich das Bedienfeld nicht ein und das Gerät funktioniert nicht.

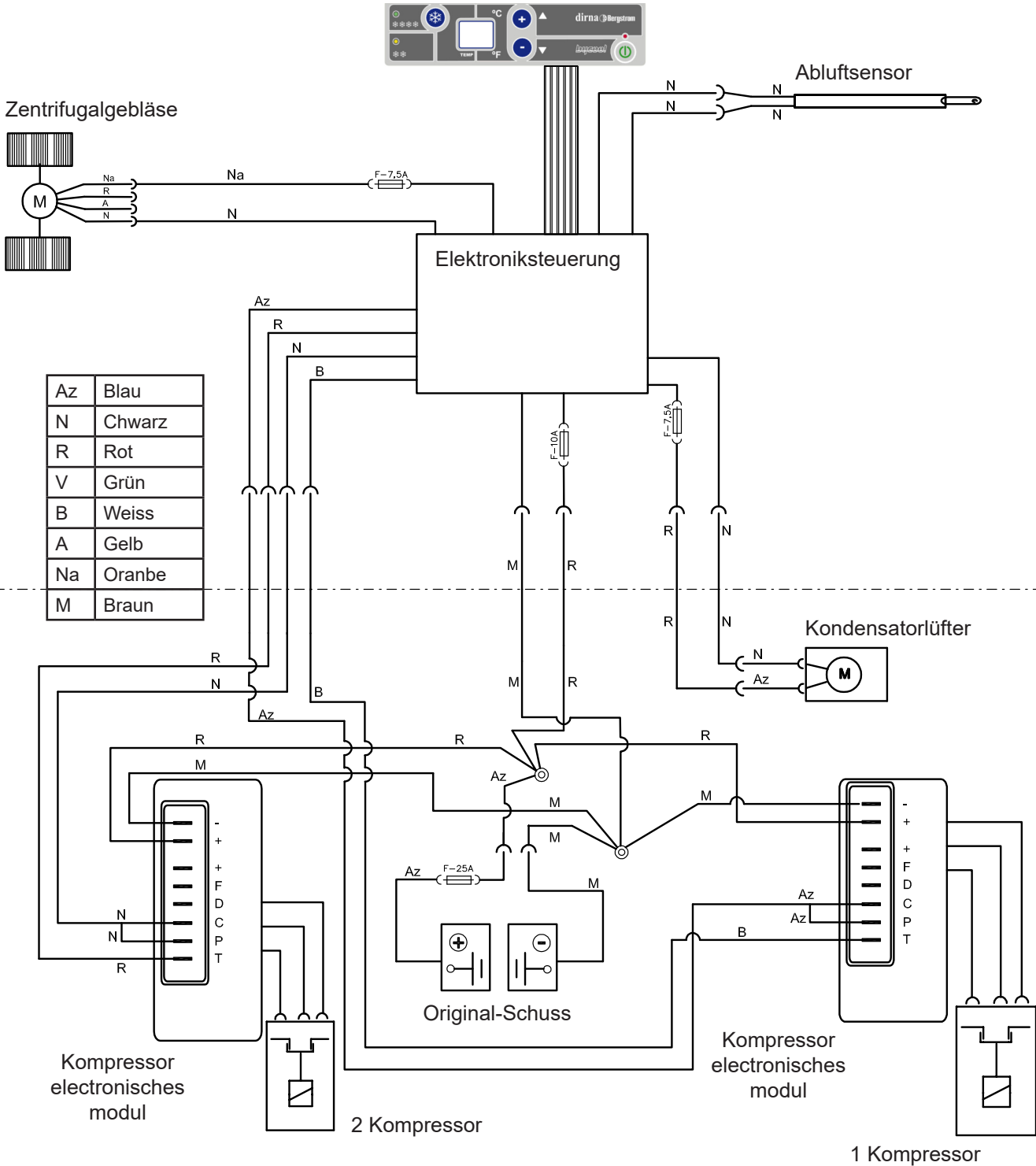

Suggerimenti per il montaggio

- Prima di cominciare il montaggio, leggere attentamente le istruzioni e rispettarle nel corso dello stesso.
- Usare gli attrezzi più adatti ad ogni operazione.

Elettricità

- Scollegare la chiave di contatto.
- Scollegare la batteria prima di cominciare il montaggio.
- Assicurarsi di avere effettuato correttamente l'installazione e il collegamento dei componenti elettrici.

Attenzione

Se durante il montaggio si inclina l'impianto, prima di rimetterlo in funzione occorre attendere almeno 60 minuti dal momento in cui è di nuovo in posizione orizzontale.

Attenzione

Quando si installa l'impianto di aria condizionata sul tettuccio, bisogna proteggere la parte superiore della cabina con uno straccio o una coperta per evitare eventuali graffi. Per l'installazione del **Compact**, tenere presente che normalmente le cabine munite di oblò dispongono di una struttura abbastanza solida per sostenere il peso dell'impianto. Tuttavia, se così non fosse e se fosse necessario tagliare il tettuccio, o se in presenza di oblò la struttura non fosse abbastanza rigida (se fosse di fibra, plastica, ecc.), è responsabilità dell'installatore decidere se occorre rinforzare il tettuccio per evitare qualsiasi deformazione, rottura o penetrazione d'acqua, ecc., prendendo le misure necessarie per evitarlo.

Attrezzi

Kit di chiavi Torx
 Kit di chiavi Allen
 Chiave fissa 10, 13, 14
 Forbici
 Metro a nastro

Documentazione allegata

Istruzioni di montaggio	220.AA6.0410
Guida dell'utente	220.AA6.0170
Soluzione dei problemi	220.AA6.0013
Garanzia	220.AA1.0017

Simbologia



Fragile









Attenzione alle mani



Tensione elettrica pericolosa

Avvertenze

-  L'installatore deve essere in possesso della formazione necessaria in materia di aria condizionata per veicoli.
-  **dirna Bergstrom, s.l.** declina ogni responsabilità per danni o rotture derivanti dall'errata installazione o dall'errato uso dell'impianto o da sostituzioni o modifiche effettuate senza la necessaria autorizzazione per iscritto.
-  **Impianto precaricato con gas refrigerante. (Non manomettere il circuito di gas refrigerante).**
-  Vedi la **procedura di garanzia** del prodotto in **Diagnosi dei problemi**.
-  Vedi la **Guida dell'utente** dell'impianto per il corretto funzionamento del telecomando e del pannello di controllo.
-  I seguenti documenti devono essere consegnati all'utente una volta conclusa l'installazione: **Guida dell'utente, Garanzia e Diagnosi dei problemi**.

 Prima di iniziare il montaggio, installare la griglia sull'entrata anteriore dell'aria.



1 Smontare coperchio tettuccio, e telaio interno e consegnare al cliente.

 Se il veicolo è munito di spoiler, è necessario smontarlo per cominciare l'installazione dell'impianto.

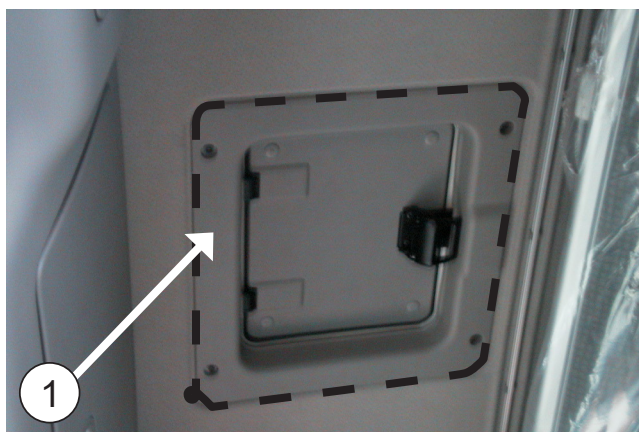
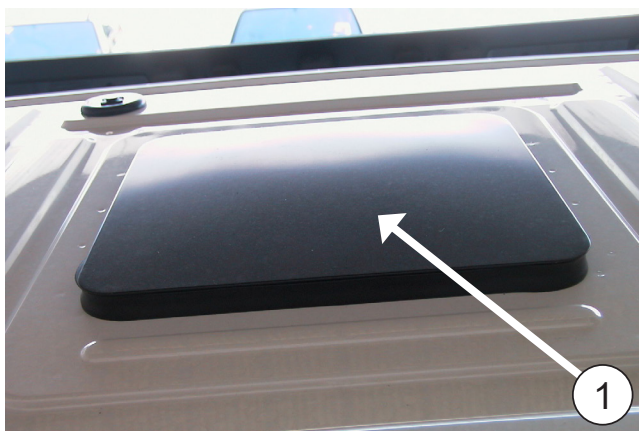

2 Incollare la guarnizione intorno al vano del tettuccio apribile rispettando la misura indicata e la posizione indicata per la guarnizione EPDM.

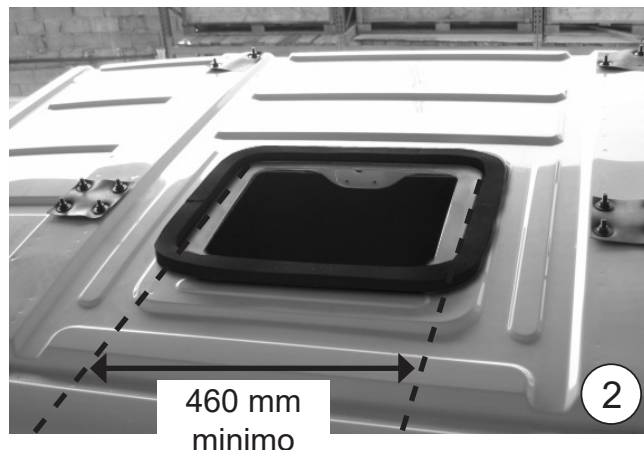

2a Particolare della collocazione della guarnizione.



 **COME TAGLIARE LA GUARNIZIONE EPDM PER EVITARE INFILTRAZIONI NELLA CABINA**

A- Incollare la guarnizione mantenendo una protezione di carta di 100 mm su ogni lato.

B- Rimuovere i due pezzi di carta.

C- Incollare premendo su entrambe le estremità.

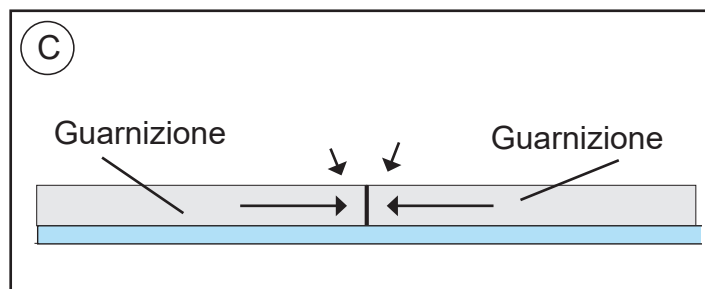
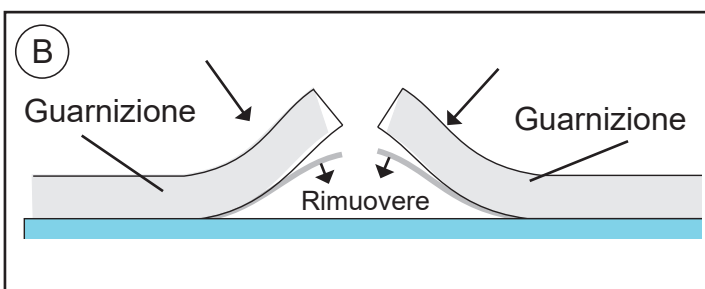
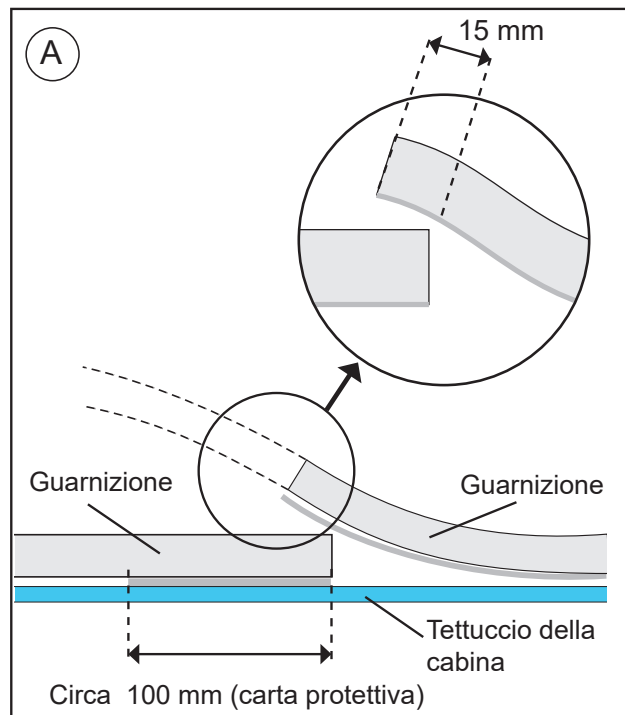

3 ESTERNO CABINA:

Inserire il **Compact** nel vano.

ATTENZIONE! Quando si posiziona l'impianto sul vano del tettuccio apribile, controllare che le uscite di scarico non siano ostruite dalla guarnizione EPDM.

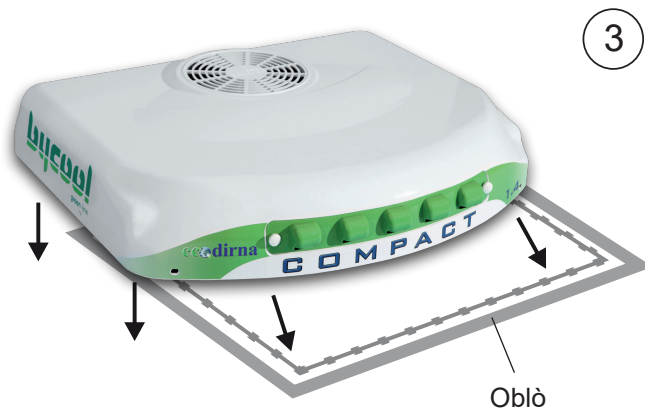

4 INTERNO CABINA:

Avvitare 5 mm circa (4) viti prigioniere 6/100x120 nella base del **Compact**.

Dal punto 5 fino al punto 10 le operazioni realizzate verranno effettuate per fare in modo che il Compact rimanga centrato, per cui non bisognerà stringere fino in fondo.

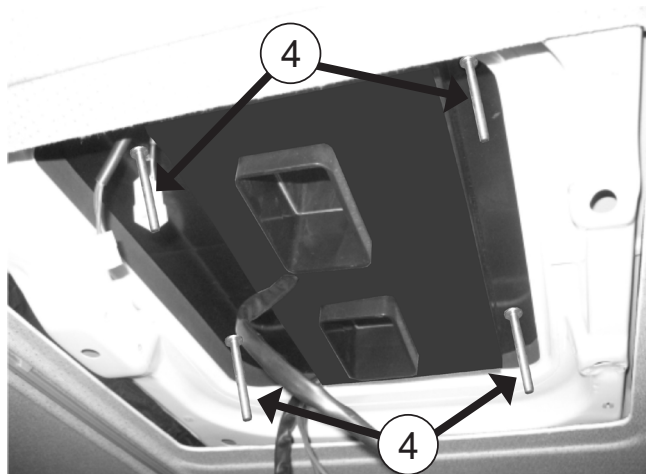

5 Collocare (1) rondella Ø 6 di gomma, (1) rondella piana Ø 6 larga, (2) dado M6 e (1) rondella piana Ø 6 larga, in ognuna delle viti prigioniere precedenti.

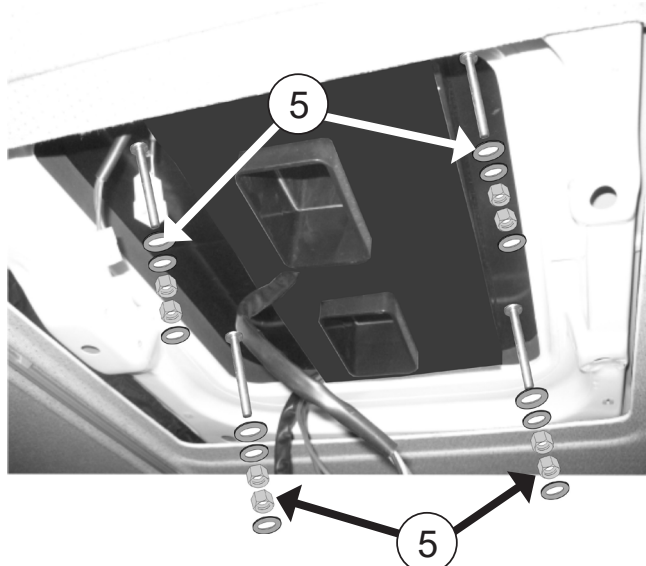

- 5a** Collocare (2) supporti di fissaggio sulle viti prigioniere tra la tappezzeria e la struttura metallica della cabina.

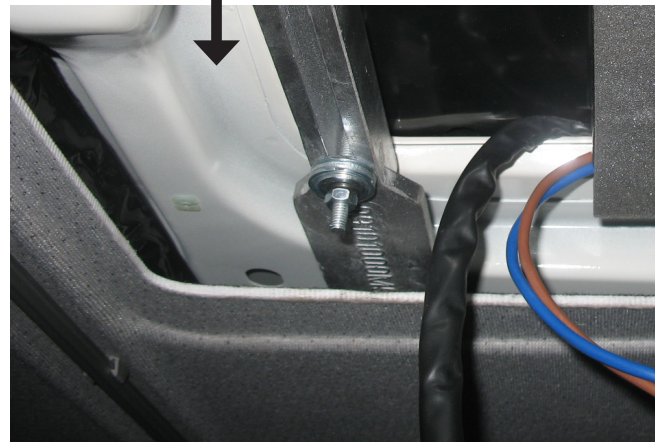
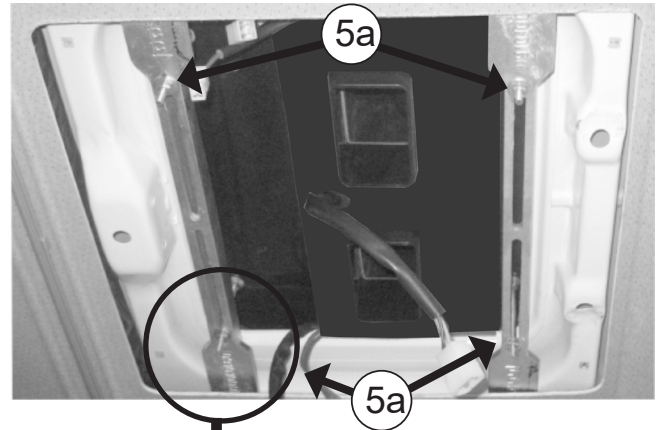

- 6** Montare il canalizzatore di gommapiuma con la parte più morbida sulla base dell'impianto.



- 7** Tra l'impianto e il pannello interno di distribuzione dell'aria, collegare le (2) scatole a 4 vie, le (2) scatole a 2 vie e collegare il cablaggio di alimentazione alla scatola a 2 vie a forma di "T".

ATTENZIONE: È molto importante non invertire i colori della scatola a 2 vie del ventilatore del condensatore (scatola con cavi R e N).



- 8** Inserire i cablaggi nel vano (H) presente nel pannello interno di distribuzione dell'aria per non intralciare l'attacco dei canalizzatori con la base dell'impianto.

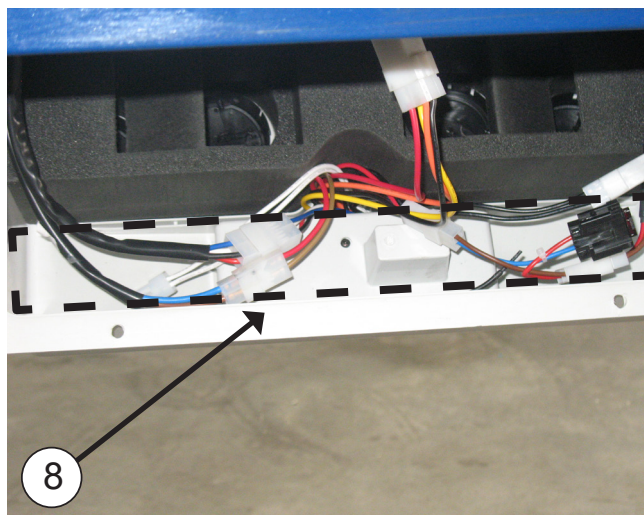

- 9** Sistemare provvisoriamente l'insieme del pannello interno di distribuzione dell'aria sui supporti di fissaggio con (4) rondelle piane da 6 mm, fissandolo con (4) dadi M6 autobloccanti e avvitare senza stringere.

Importante: I canalizzatori devono essere collocati contro la gommapiuma per evitare fughe d'aria.



- 10** Collocare la consolle con viti originali e centrare nel Compact nella posizione più adeguata sino a far coincidere le viti originali nella loro posizione.



- 11** Una volta effettuate queste operazioni, smontare la consolle, stringendo i dadi (A) fino a quando la guarnizione EPDM si comprime tra 3 e 5 mm circa, quindi stringere i dadi alla base del Compact (B) e i dadi superiori del supporto C. Schema A.

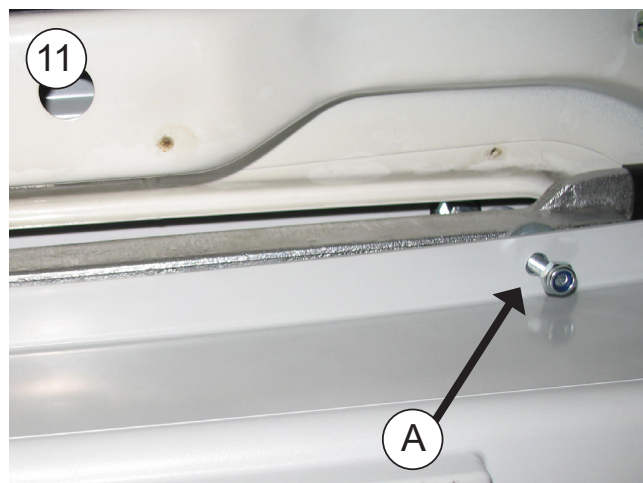

Importante: Per evitare possibili infiltrazioni d'acqua, stringere bene la guarnizione con la base del Compact - Coppia di serraggio 1.3 a 1.8 Kg Come viene indicato nello Schema A. Stringere i dadi "A" fino al serraggio della guarnizione tra 3 e 5 mm per poi stringere i dadi "B" e "C".

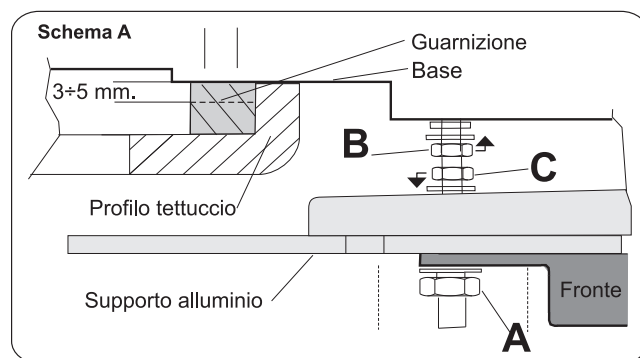

- 12** Montare di nuovo la consolle con le viti originali.

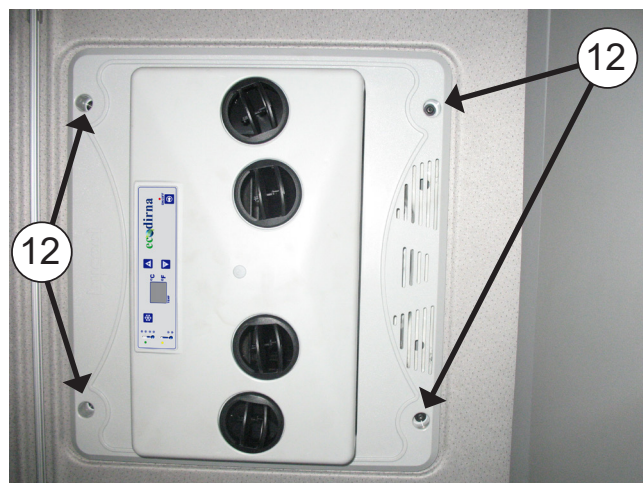

Vista dettagliata fino al fissaggio dei supporti

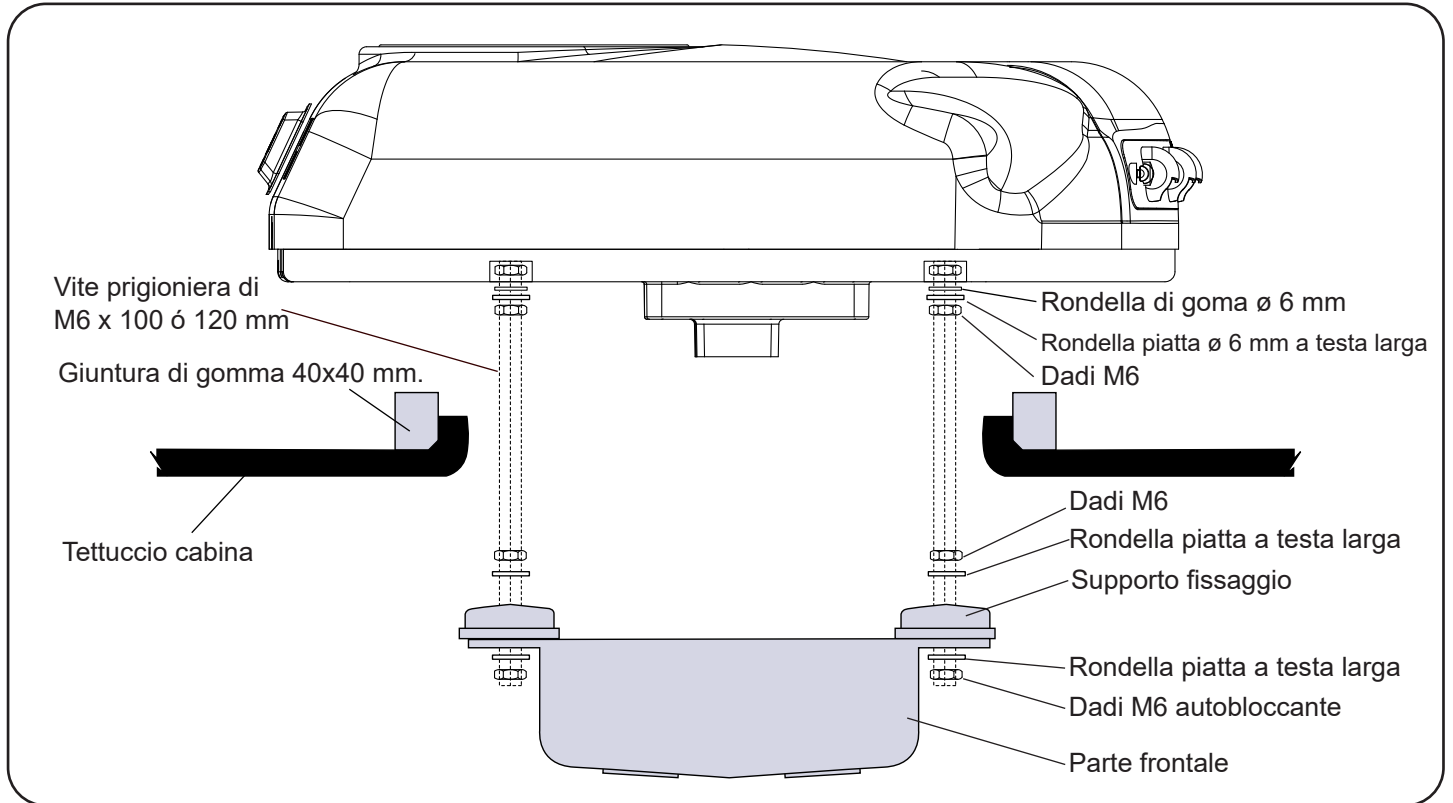

Vista dettagliata fino al fissaggio della consolle

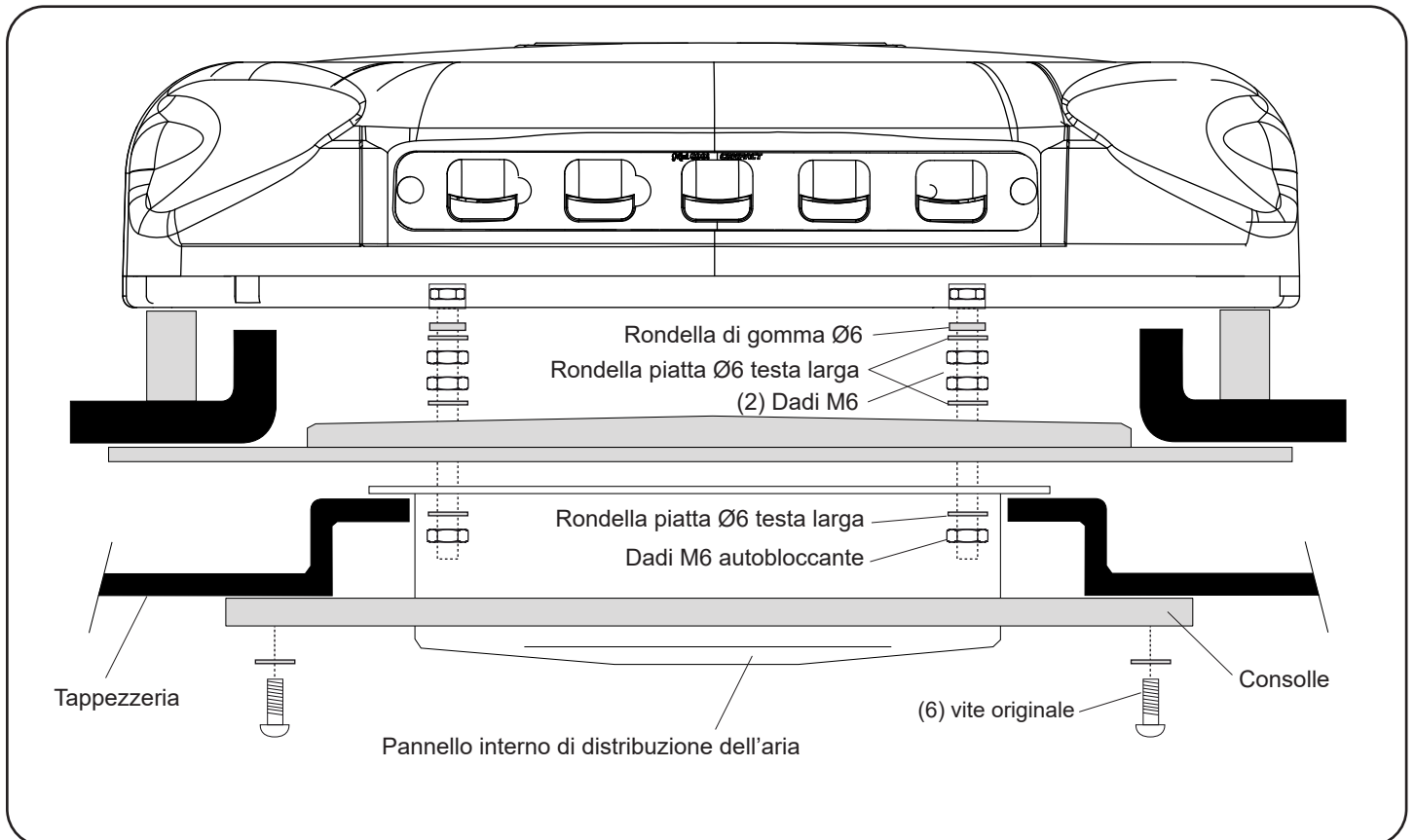

Istruzioni particolareggiate per l'installazione del cavo di alimentazione

1 Collegare il morsetto del cavo di alimentazione con il morsetto dell'impianto e fare passare il cablaggio dietro il tubo di aspirazione.

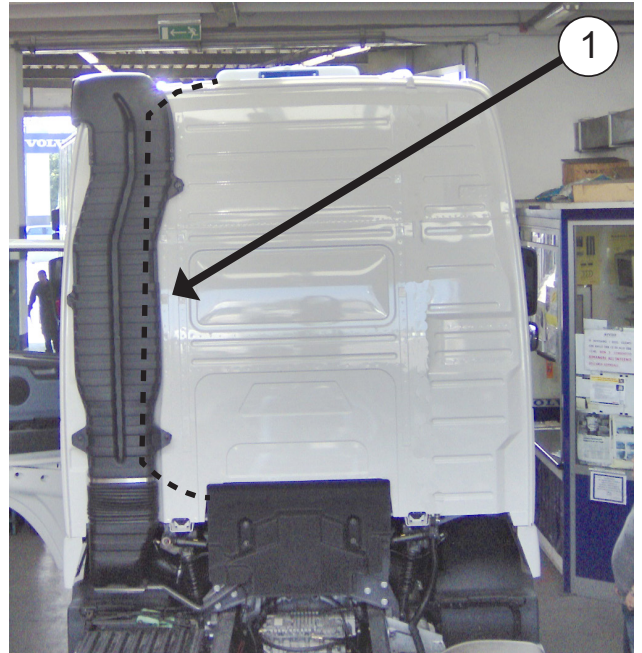
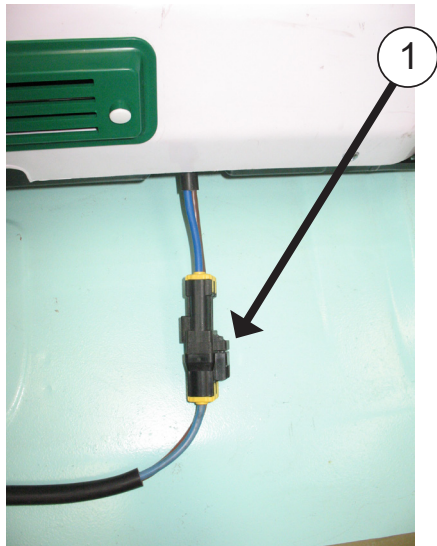

2 Ribaltare la cabina e condurre il cavo dal sito indicato fino alla presa (+) situata nella parte anteriore della cabina.

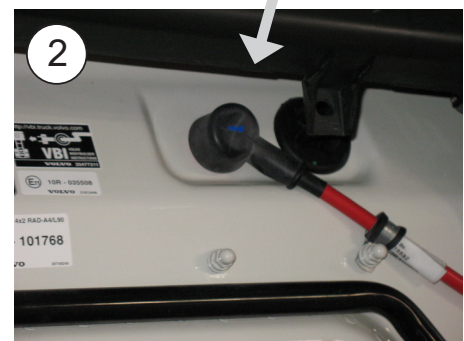
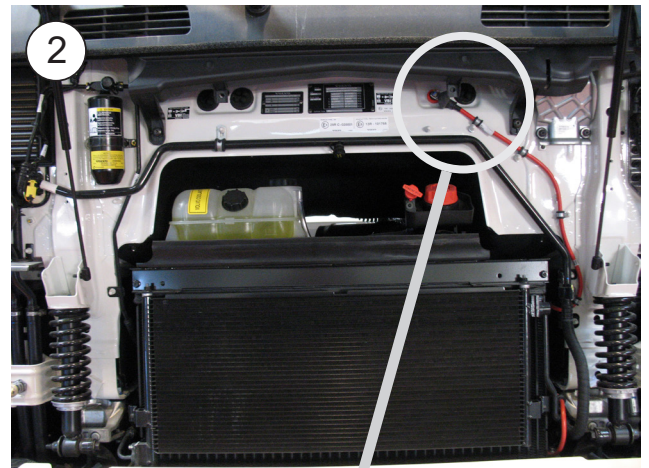
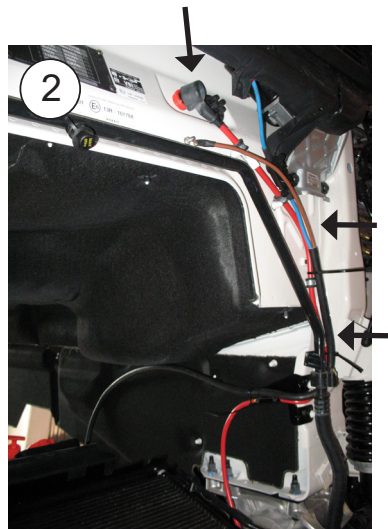
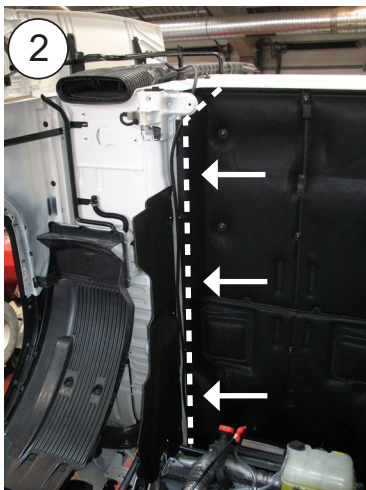

3 Smontare il dado M6 e il dado M8 della presa (+) e collegare il cavo di alimentazione come indicato.

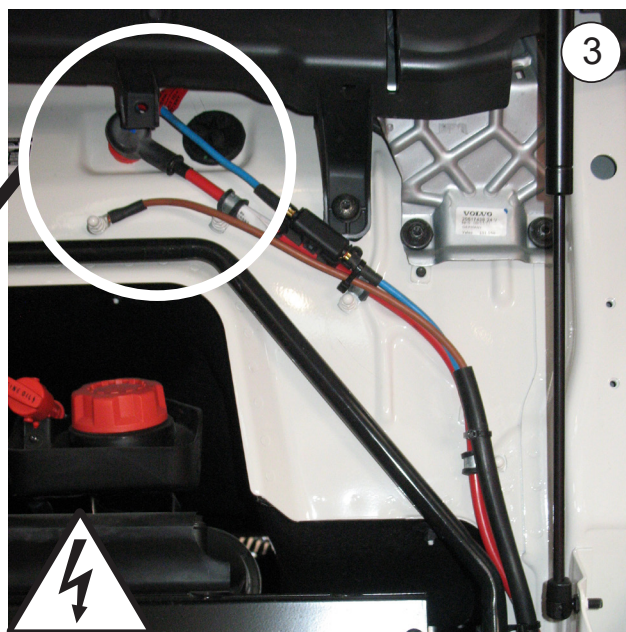
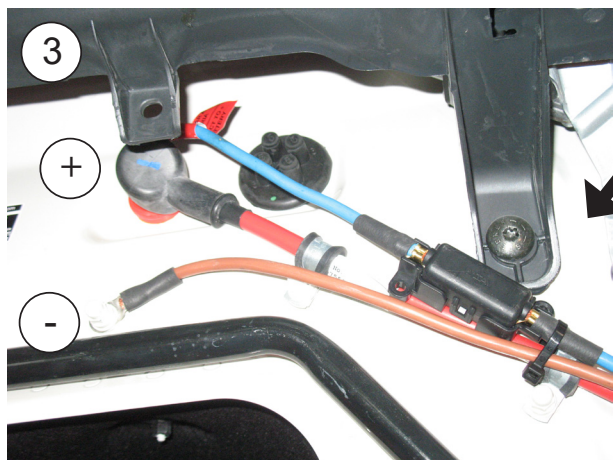

4 Con le flange fissare il cavo a quello originale.



5 Nella parte inferiore, fissare con fascette alle viti prigioniere originali.

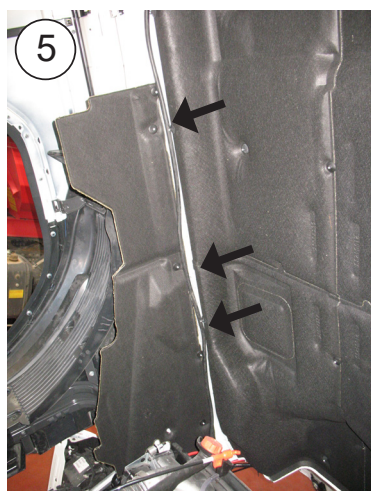

6 Ribaltare la cabina e lasciare in posizione di avvio, nascondere il cavo che avanza dietro il tubo di aspirazione.



 Se il veicolo è munito di spoiler, è necessario eseguire le modifiche indicate prima di rimontare lo spoiler nella posizione originale.

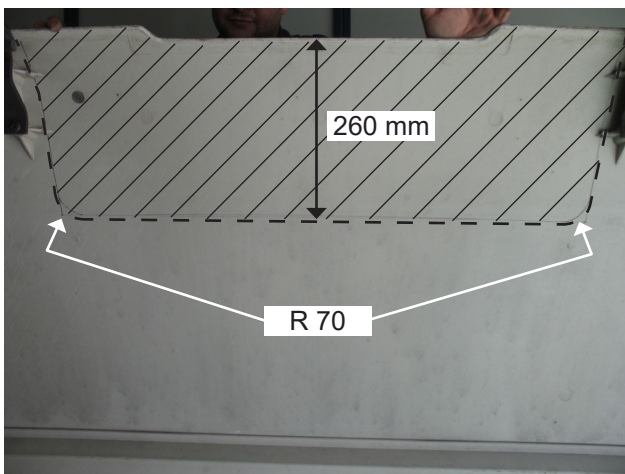

Vista dalla parte interna dello spoiler. Effettuare il taglio alle misure indicate.



Cablaggio elettrico

AVVISO IMPORTANTE!

Fare attenzione a non invertire le polarità quando si esegue il collegamento dell'impianto alla batteria. Infatti, in tal caso il quadro comandi non si accende e l'impianto non funziona.

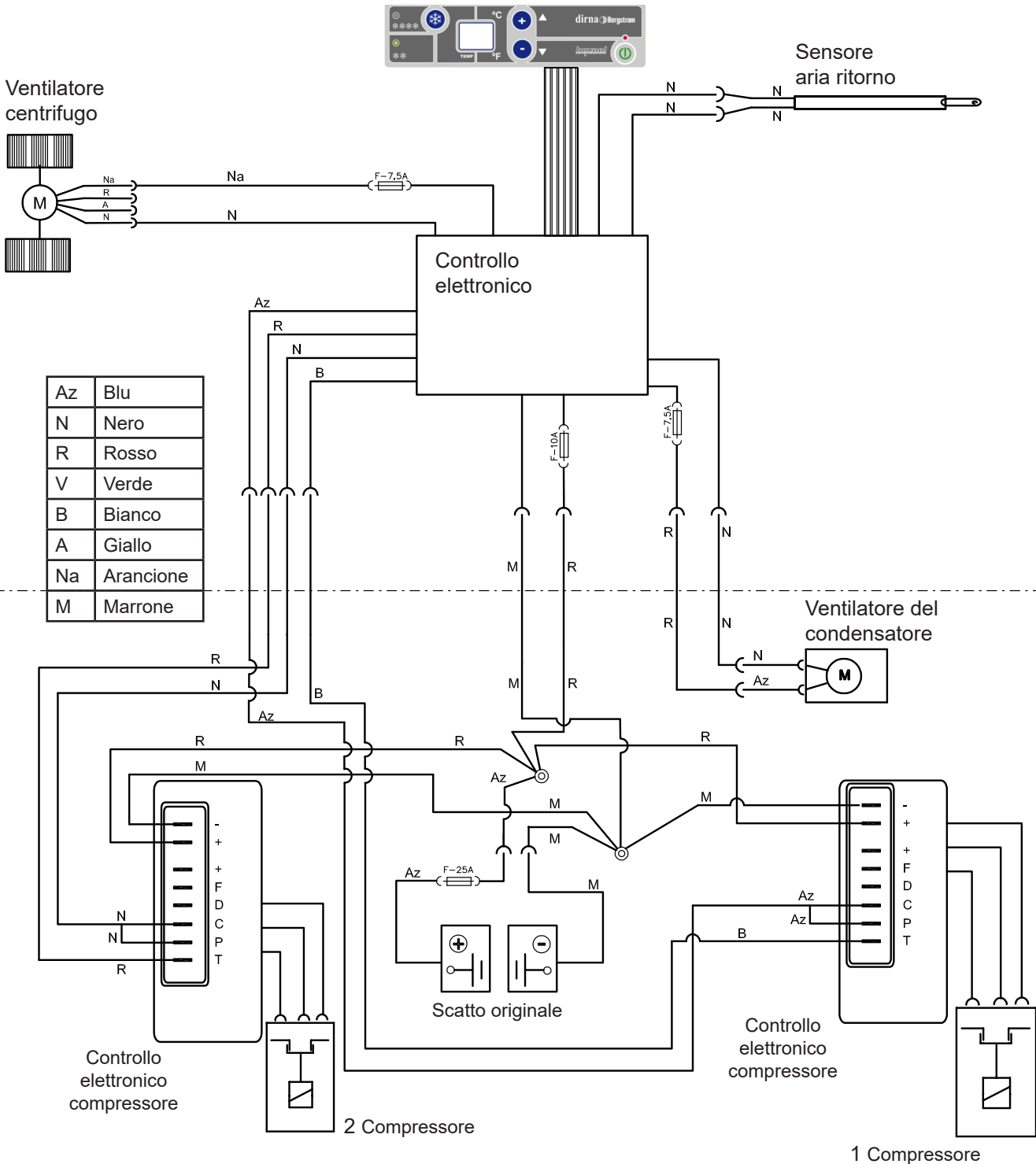

Ed:	07/06/2011
Md:	28/08/2019





g

dirna  **Bergstrom**

Francisco Alonso, 6
28806 Alcalá de Henares, Madrid
SPAIN

Contact	Phone	Fax	E-Mail
Sales (Ventas Internacional)	+34 91 8770510	+34 91 8771158	sales@dirna.bergstrominc.com
Comercial Nacional	+34 91 8775841	+34 91 8836321	ventas@dirna.bergstrominc.com
Orders & Deliveries (Logística internacional)	+34 91 8775846	+34 91 8771158	export@dirna.bergstrominc.com
Orders & Deliveries (Logística nacional)	+34 91 8775840	+34 91 8836321	comercial@dirna.bergstrominc.com
Technical Assistance (Internacional)	+49 511 86679681	+49 511 86679710	technicalassistance@dirna.bergstrominc.com
Technical Assistance (Nacional)	+34 91 8775845	+34 91 883 6321	oblanco@dirna.bergstrominc.com

www.dirna.com

	ATENCIÓN:	Dirna Bergstrom se reserva el derecho de efectuar modificaciones en cualquier momento de los datos contenidos en esta publicación, por razones técnicas o comerciales.
	NOTE:	<i>For technical and commercial reasons, Dirna Bergstrom reserves the right to change the data contained in this brochure.</i>
	ATTENTION:	Dirna Bergstrom se réserve le droit d'effectuer à tout moment des modifications des données reprises sur cette publication, pour des raisons techniques ou commerciales.
	HIWEIS:	<i>Dirna Bergstrom behält sich vor, aus technischen oder kaufmännischen Gründen jederzeit Änderungen der Angaben dieser Veröffentlichung vorzunehmen.</i>
	ATTENZIONE:	Dirna Bergstrom si riserva il diritto di effettuare modifiche in qualsiasi momento ai dati contenuti in questa pubblicazione, per motivi tecnici o commerciali.