

# LITE

## FORD

### F-Max H625



**Instrucciones de Montaje**

*Mounting Instructions*

**Instructions de Montage**

*Montageanweisungen*

**Istruzioni di Montaggio**

**ES** Spanish

**EN** English

**FR** French

**GE** German

**IT** Italian

## Recomendaciones Para el montaje

- Antes de iniciar el montaje leer las instrucciones y seguirlas durante el proceso de instalación.
- Usar las herramientas adecuadas para cada operación.

## Electricidad

- Desconectar la llave de contacto.
- Desconectar la batería antes de empezar el montaje.
- Asegurar el conexionado de los componentes eléctricos, verificando su correcto encaje.

### Atención

Si durante el montaje el equipo se inclina o se abate la cabina con el equipo montado, se deberá esperar un mínimo de 60 minutos, desde que el equipo quede horizontal, antes de ponerlo en marcha.

### Atención

Al instalar el equipo de aire acondicionado en el techo se debe proteger la parte superior de la cabina con un paño o manta protectora para evitar posibles arañazos. Al instalar **LITE** en el techo hay que tener en cuenta que, normalmente, las cabinas que vienen provistas de escotilla, tienen una estructura suficiente para soportar el peso del equipo. Sin embargo, cuando no ocurra así y sea necesario realizar corte en el techo o incluso si en el caso de llevar escotilla el material no es lo suficientemente resistente (caso de techo de fibra, plástico, etc...) es el instalador el que debe decidir, **bajo su responsabilidad**, sobre la necesidad de reforzar el techo para evitar posibles deformaciones, roturas, entradas de agua, etc... habilitando los medios para que esto no ocurra.

## Herramientas

Juego de Llaves Torx

Juego de Llaves Allen

Llave fija 13, 14, 22

Tijeras

Flexómetro

Destornillador

## Documentación relacionada

Instrucciones de montaje	1002810223
Manual del usuario	1001335089
Diagnóstico de averías	1001335088
Listado de recambios	1002810225

## Simbología



Frágil





Atención corte!





Riesgo eléctrico

## Advertencias

 El personal instalador debe poseer una formación suficiente en Aire Acondicionado de vehículos.

 **Bergstrom** queda exenta de responsabilidad si se producen averías que procedan de una inadecuada manipulación o instalación del equipo, o por modificaciones y sustituciones efectuadas sin nuestra expresa autorización por escrito.

 **Equipo precargado con gas** refrigerante R-134a. **(No manipular el circuito de gas refrigerante).**

 Véase **procedimiento de garantía** del producto incluido en **Diagnóstico de Averías**.

 Véase **Manual de Usuario** del equipo para el correcto funcionamiento del mando a distancia y del panel de control.

 Al finalizar la instalación se debe entregar al usuario: **Manual del Usuario, Garantía y Diagnóstico de averías**.

 **El equipo no cumple con la normativa ADR.**

- 1 Desmontar escotilla y los elementos de fijación y entregar éstos al cliente.

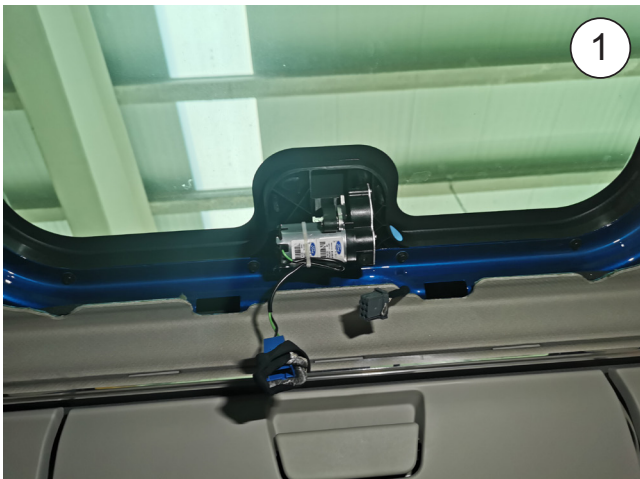

**2** Pegue la junta EPDM 30x25 alrededor del hueco escotilla (mirar detalle para cortar los bordes finales de la unión de la junta).



**Atención:** La junta EPDM tiene que estar pegada junto al saliente del hueco de la escotilla.

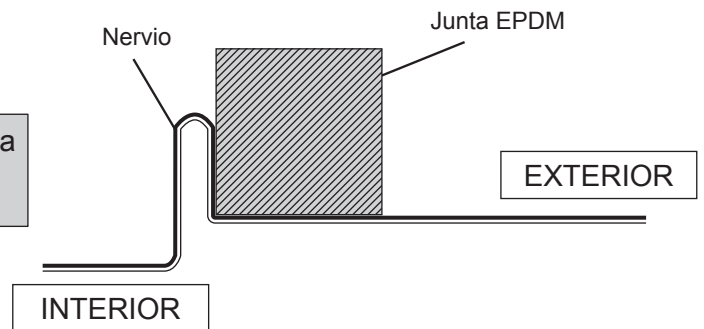

**COMO CORTAR LA JUNTA EPDM PARA EVITAR FILTRACIÓN DE AGUA EN LA CABINA**

**A-** Pegar la junta, manteniendo 100 mm de papel protector por cada lado.

**B-** Quita los dos piezas de papel.

**C-** Pegue presionado ambos finales.

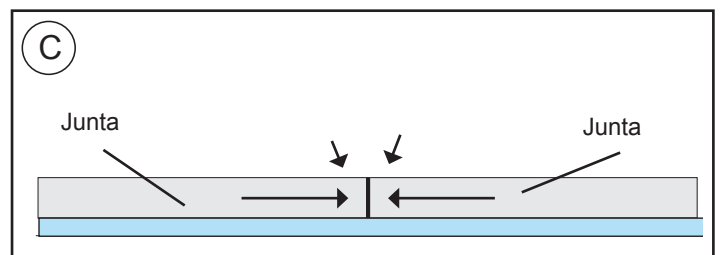
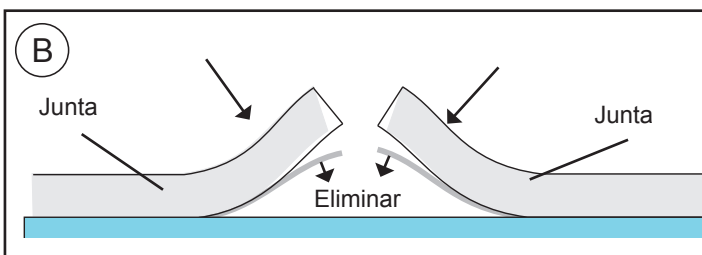
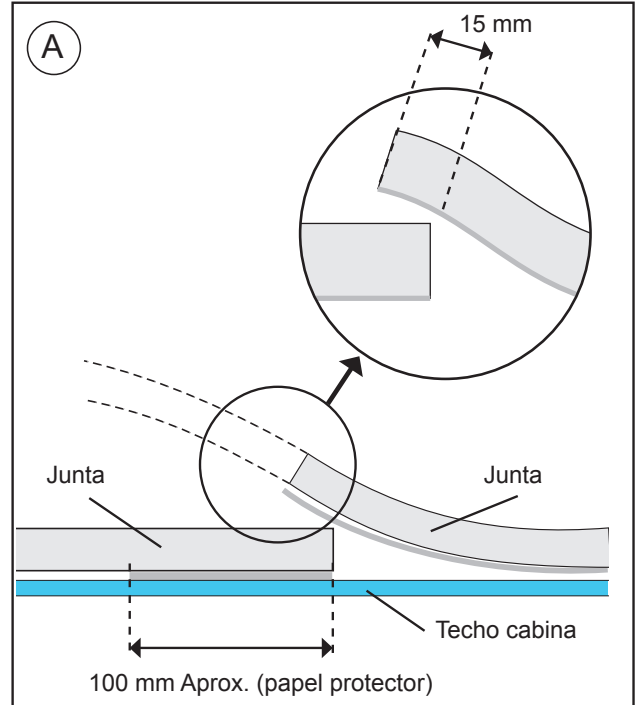

**3** Posicionar el equipo sobre la junta introduciendo el panel interior de distribución en el hueco de escotilla.

**¡Atención!** Al colocar el equipo sobre el hueco escotilla, verificar que las salidas de desagüe no queden obstruidas por la junta EPDM.



**4** Roscar (4) hexágonos M8/125x26 con arandela goma, arandela plana en insertos de la base y apretar con un par de apriete de  $12,7 \pm 10$  Nm.

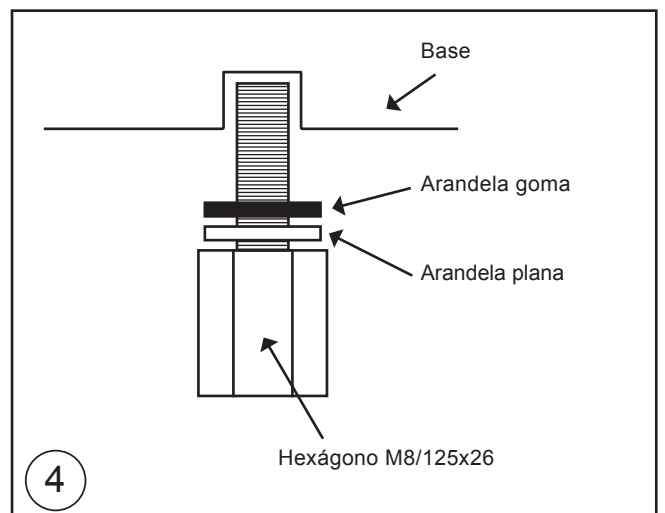

**5** Colocar soportes de fijación con arandela plana, arandela grower y tornillo M8/125x50 **sin apretar**.

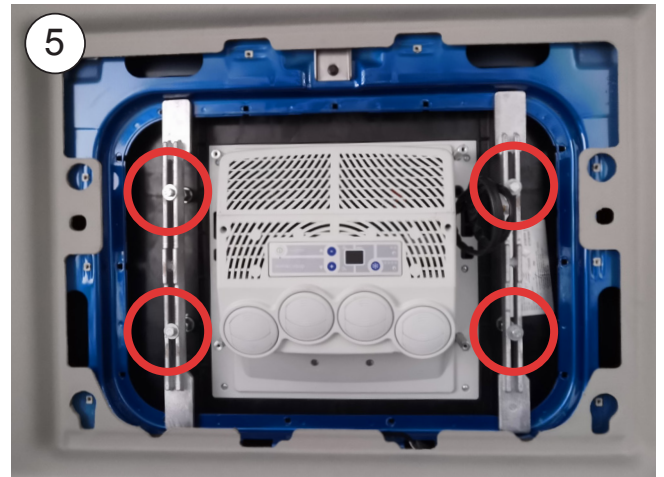

**6** Roscar (4) hexágonos M6 L=94 y apretar con un par de apriete de  $4,75 \pm 10\%$  Nm, como se indica en la imagen.

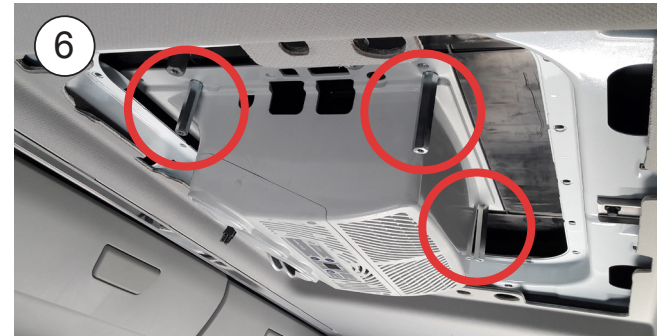

**7** Presentar consola, como se indica en la imagen, y centrar el equipo. Para ello se verificará que las ranuras de la base no se vean, quedando apoyadas sobre la junta EPDM.



- 8** Retirar la consola y apretar tornillos M8/125x50 hasta hacer tope con los hexágonos para fijar el equipo.



- 9** Llevar cables de alimentación hasta escotilla y grapar en éstos los terminales suministrados y colocar caja de 2 vías suministrada.

**Atención:** hacer coincidir cables según se indica, R= (+) y N= (-).

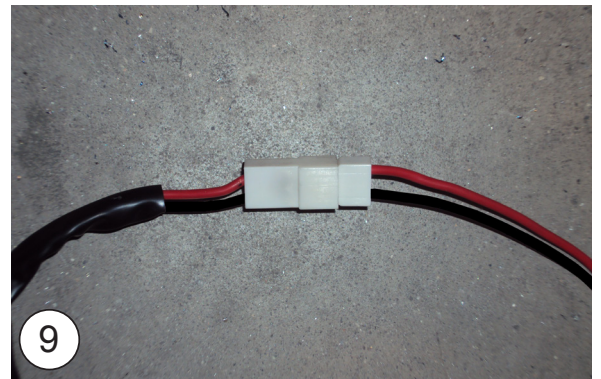

- 10** Colocar la consola con (4) tornillos M6/100x15.

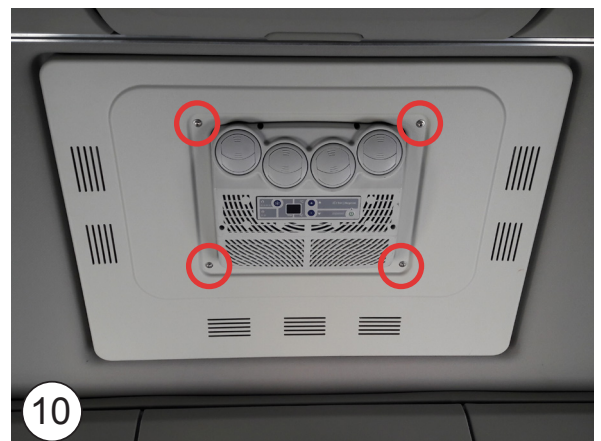

### Vista explosionada hasta la fijación de los soportes

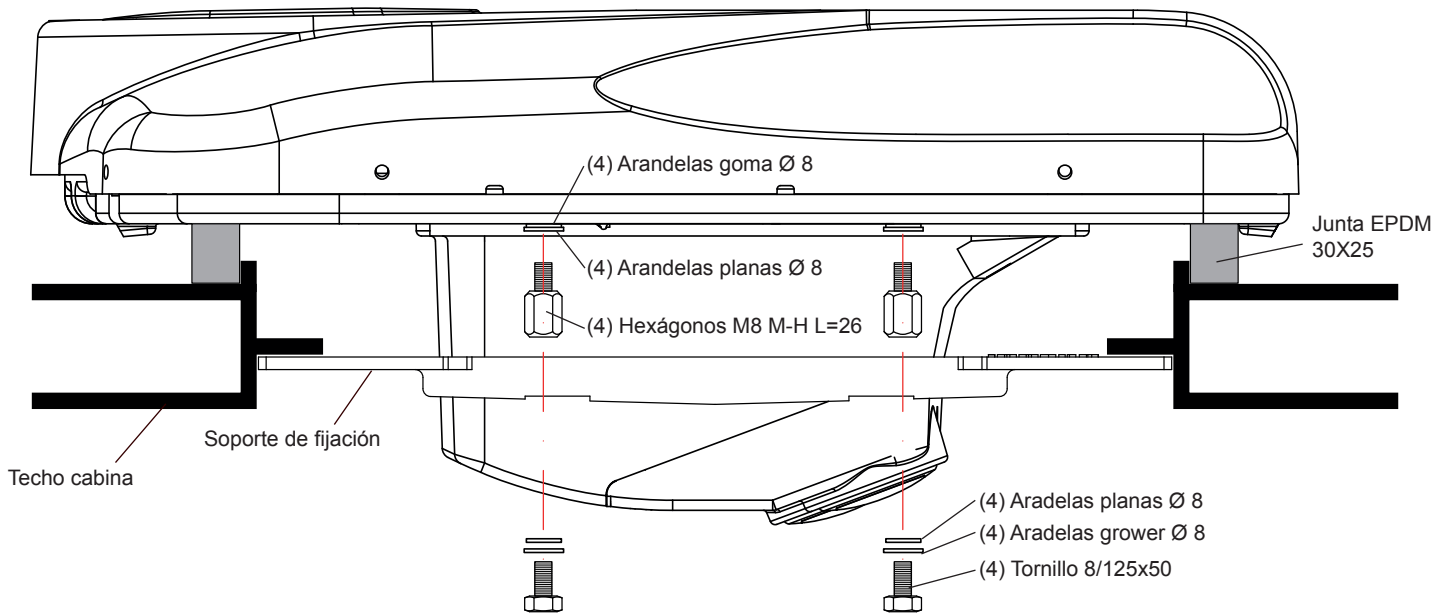

### Vista explosionada hasta la fijación de la consola

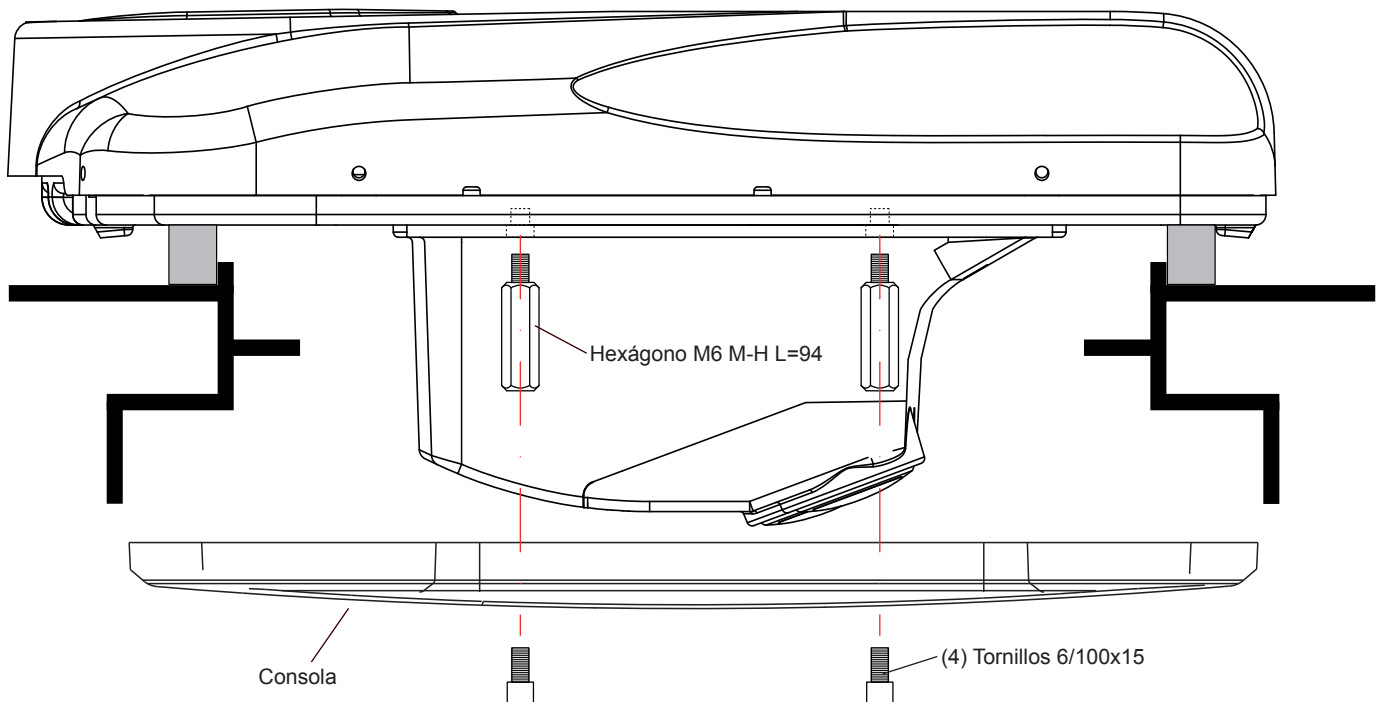



**¡AVISO IMPORTANTE!**

**Precaución** de no invertir las polaridades al conectar el equipo a la batería. Si esto sucediera la placa de mandos no se enciende y el equipo no funciona.

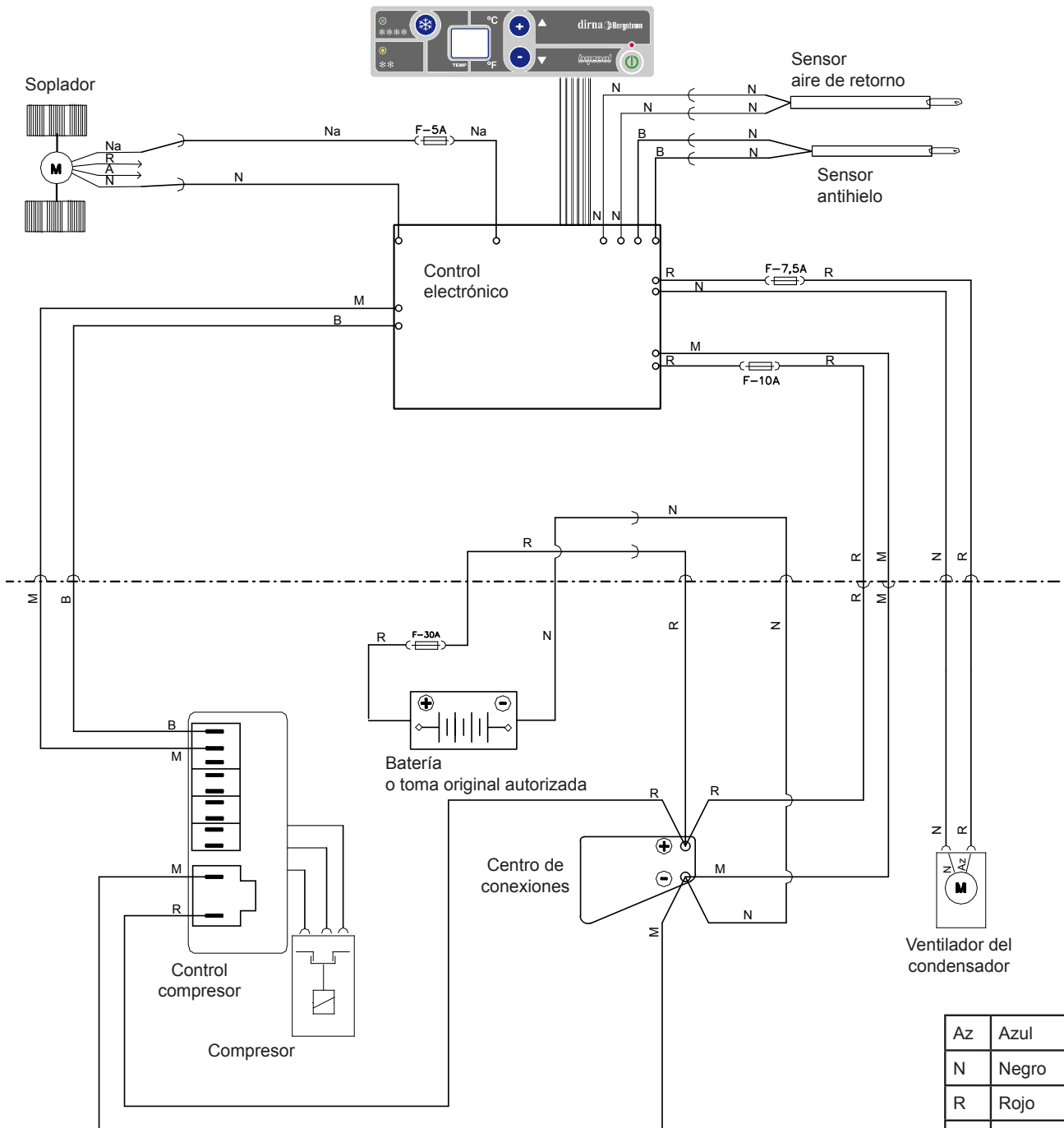

Az	Azul
N	Negro
R	Rojo
V	Verde
B	Blanco
A	Amarillo
Na	Naranja
M	Marrón

## Assembly Recommendations

- Before starting assembly, please read instructions and follow them during installation process.
- Use the adequate tools for each operation.

## Electricity

- Disconnect ignition key.
- Disconnect battery before starting assembly.
- Make sure electric components are securely connected, checking their correct fitting.

## Warning

**If the unit slants during assembly, wait for at least 60 minutes with the unit in horizontal position before starting it up.**

## Warning

When installing air conditioning equipment on roof, the upper cabin part must be protected with a cloth or a protective blanket to avoid possible scratches. When installing **LITE** on roof, take into account that, normally, cabins equipped with a hatch have a strong enough structure to hold equipment weight. However, if it is not the case and it is necessary to carry out a cut in the roof or, although it has a hatch, the material is not resistant enough (*if roof is made of fibre, plastic, etc...*), it is the installer who will have to decide, under his responsibility, if it is necessary to reinforce the roof to avoid possible deformations, breaks, water entries, etc., habilitating the means required to stop it from occurring.



## Tools

- Torx wrenches set
- Allen wrenches set
- Open-jawed spanner 13, 25
- Scissors
- Flexo-meter
- Screwdriver







## Related documentation

Mounting instructions	1002810223
User's guide	1001335089
Troubleshooting	1001335088
Parts list	1002810225

## Symbology

-  Fragile
-  Beware of cuts!
-  Electrical hazard

## Warnings

-  The installing personnel must have a sufficient training in vehicles air conditioning.
-  **Bergstrom** shall not be responsible for breakdowns or damages coming from an inadequate handling or installation of the equipment or from modifications and substitutions carried out without our express and written authorisation.
-  **Equipment pre-charged with refrigerating gas. (Do not handle refrigerating gas circuit).**
-  Please see product **warranty procedure** included in **Troubleshooting**.
-  Please see equipment **User's Guide** for its correct functioning of the remote control and control panel.
-  Once installation is finished, the following documents must be handed over to the user: **User's Guide**, **Warranty** and **Troubleshooting**.
-  **The unit does not comply with ADR regulations.**

- 1 Take down the hatch and the fastening elements, and hand them over to the customer.

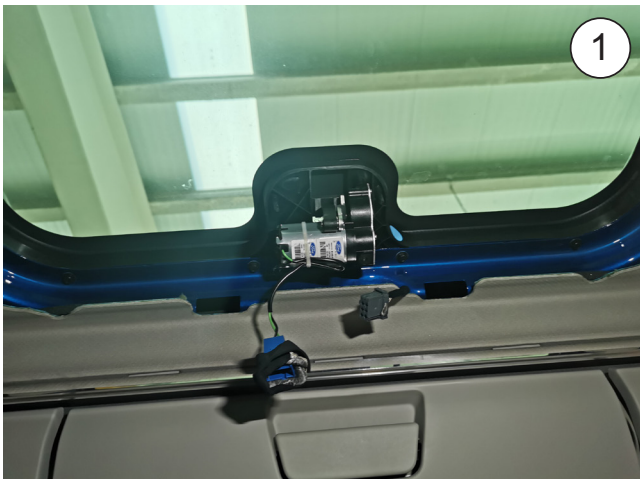
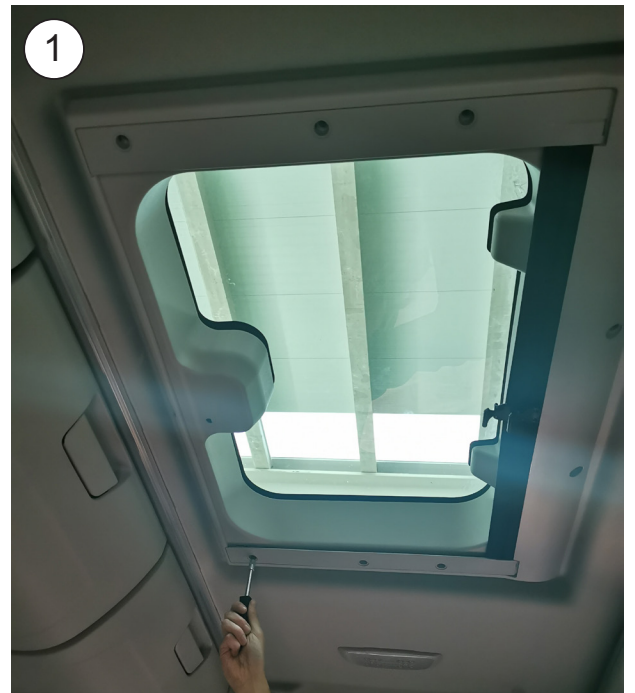

**2** Attach the EPDM 30x25 seal around the hatch gap (see the details to cut the ends of the seal joint).

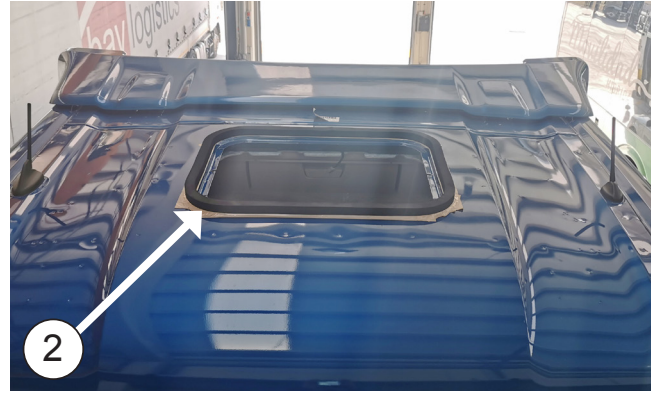

 **Take care:** The EPDM seal must be secured to the projecting edge of the hatch gap.

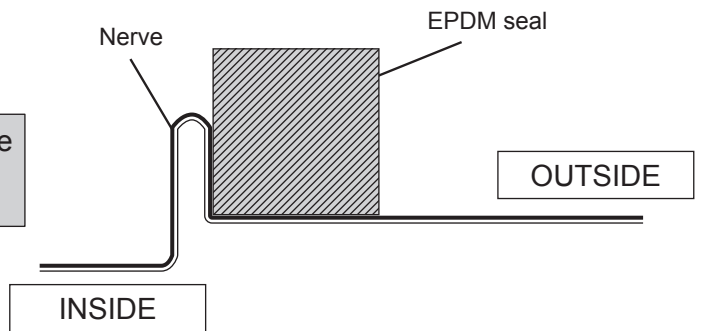

 **HOW TO CUT EPDM GASKET TO AVOID WATER FILTRATION INTO THE CABIN**

- A-** Glue gasket, keeping 100 mm of protection paper at each side.
- B-** Remove the two pieces of paper.
- C-** Glue by pressing both ends.

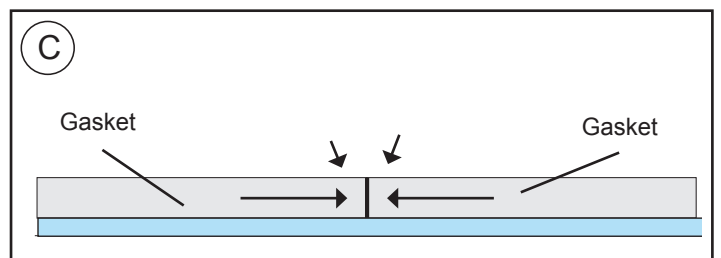
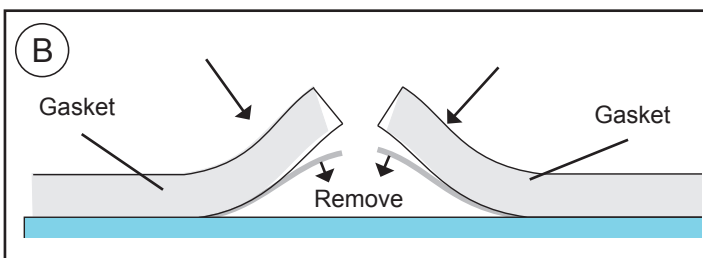
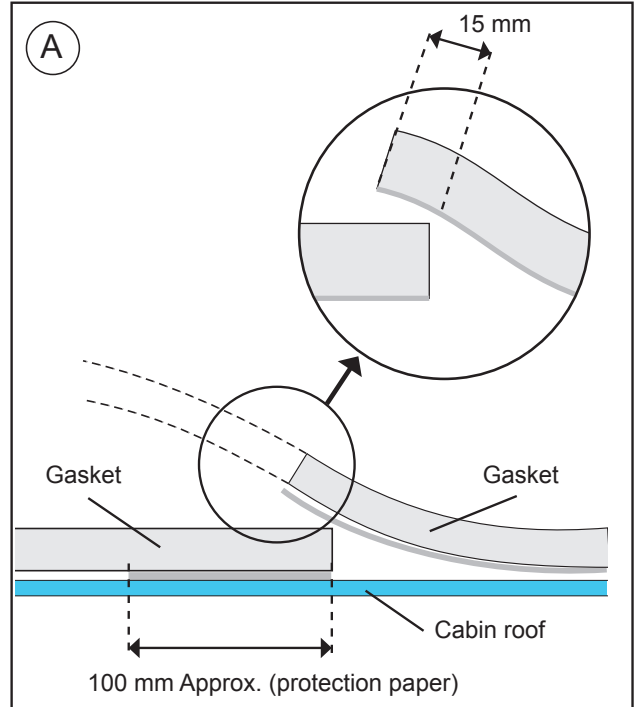

**3** Position the unit on the seal, introducing the interior distribution panel in the hatch gap.

**Caution!** When positioning the unit above the hatch gap, check that the wastewater run-offs are not blocked by the EPDM seal.



**4** Screw (4) M8/125x26 hexagons with rubber washer, flat washer in the base inserts, and tighten with a torque of  $12.7 \pm 10$  Nm.

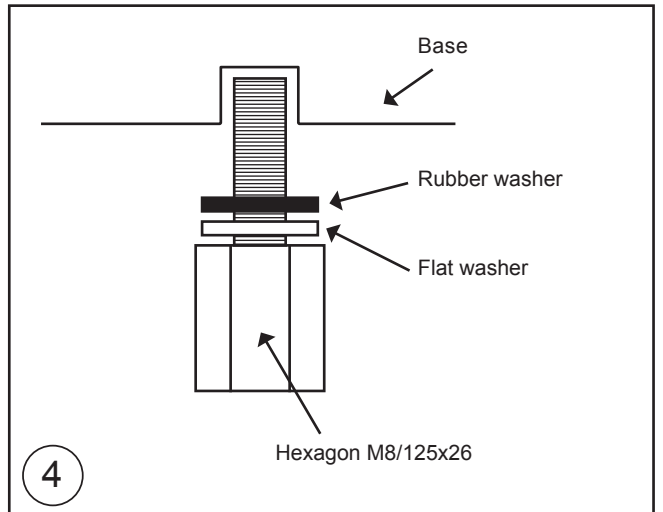

**5** Position the fastening mounts with a flat washer, grower washer and M8/125x50 screw, **without tightening**.

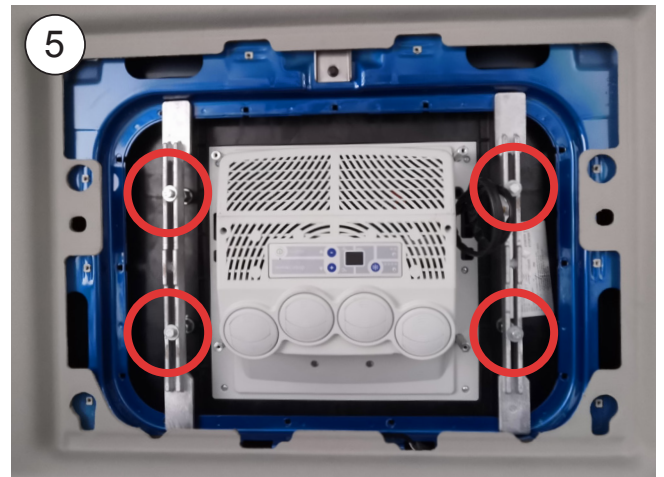

**6** Screw on (4) L=94 M6 hexagons and tighten with a torque of  $4.75 \pm 10\%$  Nm, as shown in the photo.

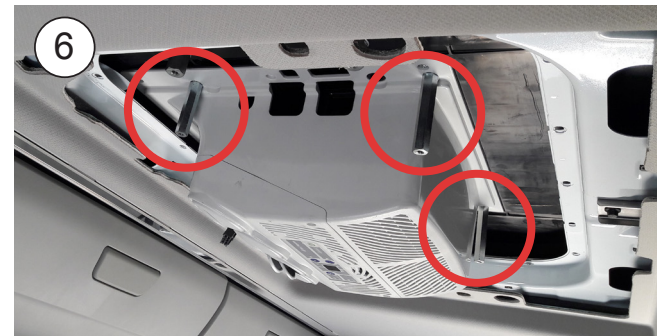

**7** Position the console as shown in the photo, and align the unit. The slots in the base must first be checked to ensure they are not visible and are supported on the EPDM seal.



- 8** Remove the console and tighten the M8/125x50 screws up to the hexagons, in order to secure the unit.



- 9** Run power cables to the hatch and secure the supplied terminals on them, positioning the supplied 2-way box.

**Caution:** match the cables as indicated, R= (+) and B= (-).

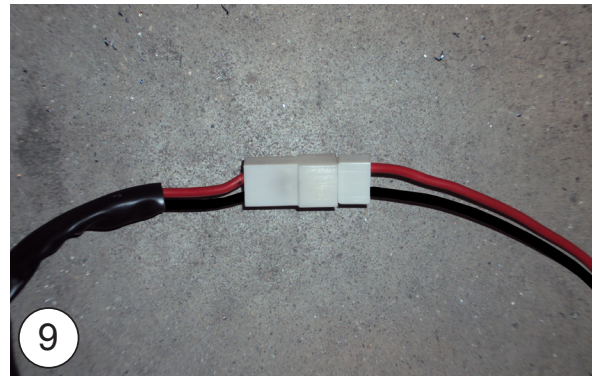

- 10** Position the console with (4) M6/100x15 screws.

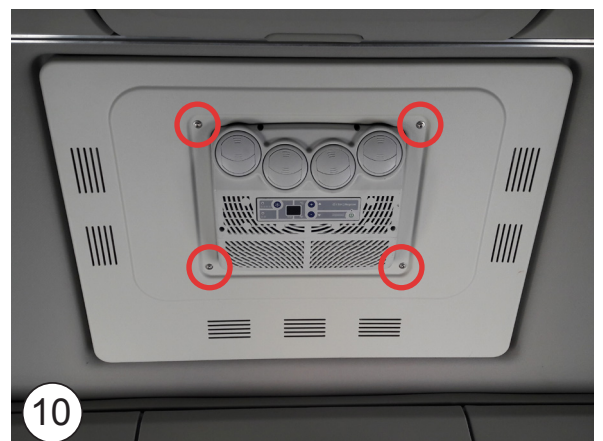

### Exploded drawing to fixing brackets

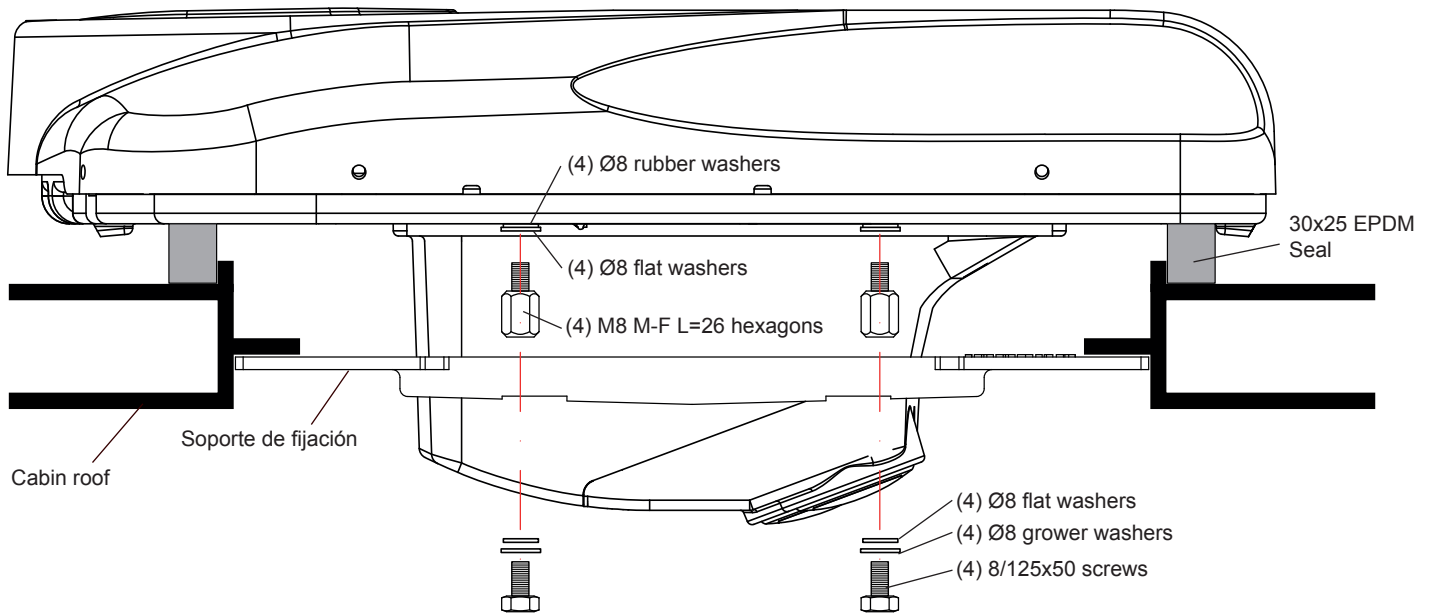

### Exploded view to securing the console

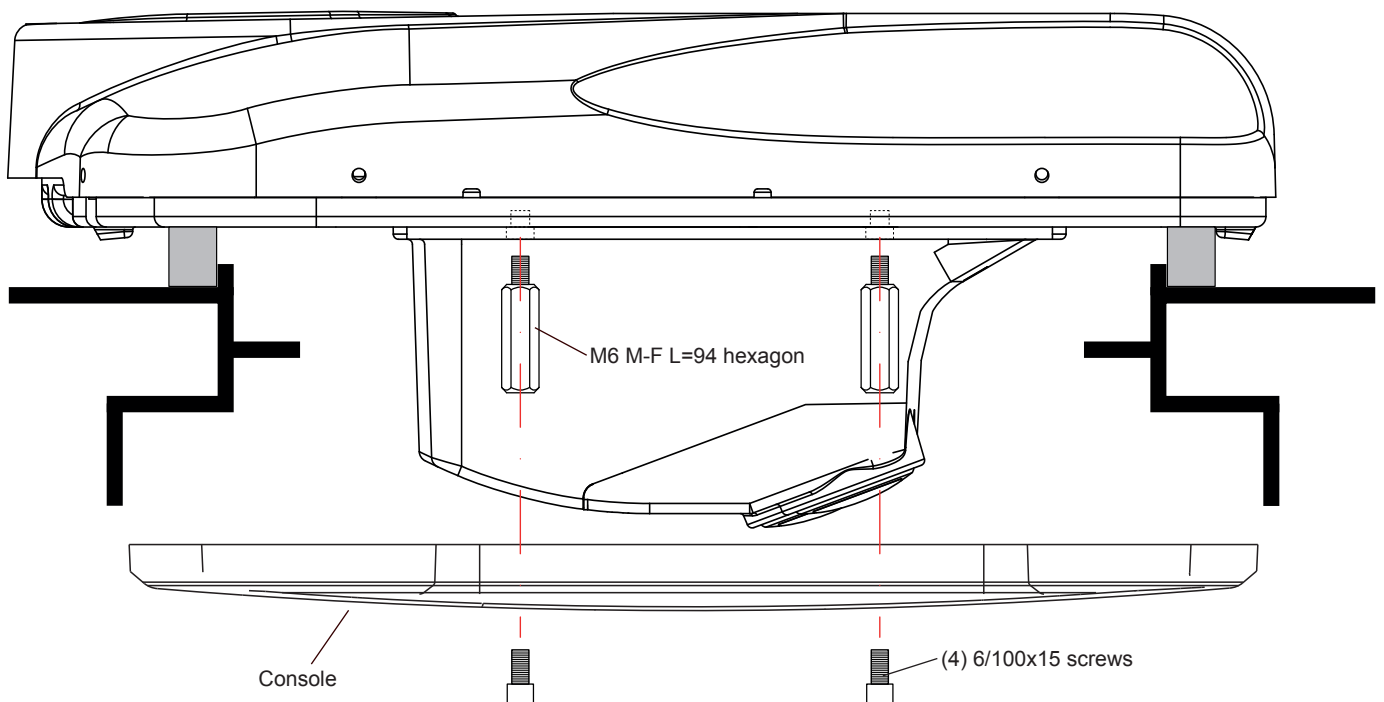



Wiring diagram

**IMPORTANT WARNING!**

**Take care** not to invert the polarities when connecting the unit to the battery. If this happens, the control plate does not come on and the unit does not work.

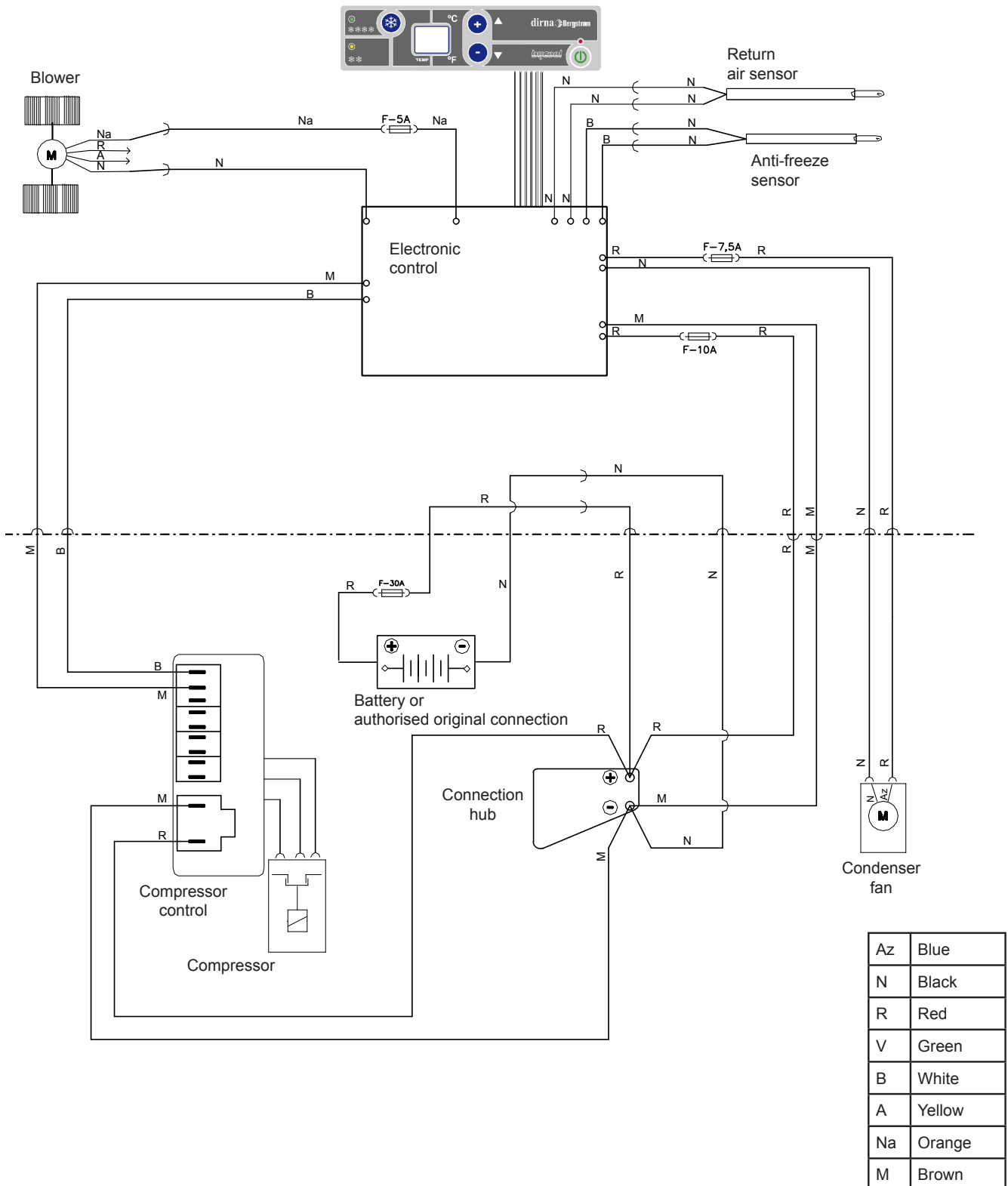

## Recommandations Pour Le Montage

- Avant de commencer le montage de l'appareil, prière de lire les instructions et de les suivre attentivement.
- Utiliser les outils convenant à chaque opération.

## Electricity

- Déconnecter la clé de contact.
- Déconnecter la batterie avant de commencer le montage.
- Vérifier le câblage des composants électriques et leur correcte installation.

### Attention

Si pendant le montage l'équipement est incliné, il faudra attendre au moins 60 minutes avant de le mettre en marche une fois qu'il aura été remis sur sa position horizontale.

### Attention

Lors de l'installation de l'appareil d'air conditionné sur le toit, il faudra protéger la partie supérieure de la cabine avec un linge ou une couverture de protection afin d'éviter les éventuelles égratignures.

Durant l'installation du LITE, tenir compte du fait que normalement les cabines pourvues d'écoutille possède une structure suffisamment solide pour supporter le poids de l'appareil. Cependant, si ce n'est pas le cas et qu'il est nécessaire de découper le toit ou même si disposant d'écoutille, la structure n'est pas suffisamment rigide (si elle était en fibre, plastique, etc.) il appartiendra à l'installateur de décider s'il faut renforcer le toit pour éviter toute déformation, rupture ou voie d'eau, etc., et prendre les mesures nécessaires à cet effet.

## Outils

Jeu de clés Torx

Jeu de clés Allen

Clé fixe 13, 14, 22

Ciseaux

Mètre

Tournevis

## Documentation associée

Instructions de montage	1002810223
Guide de l'utilisateur	1001335089
Solution des problèmes	1001335088
Liste de rechanges	1002810225

## Symbologie



Fragile





Attention aux coupures !



Risque électrique

## Garantie

 L'installateur devra posséder la formation pertinente en air conditionné sur véhicules.

 **Bergstrom** ne sera pas responsable des dommages ou des bris dérivés d'une installation ou d'une manipulation incorrecte ni des modifications réalisées sans autorisation expresse par écrit.

 **Appareil pré-chargé de gaz réfrigérant R-134. (Ne pas manipuler le circuit de gaz réfrigérant).**

 Voir **la procédure de garantie** du produit au **Diagnostic de problèmes**.

 Voir le **Guide de l'Usager** de l'appareil pour le fonctionnement correcte de la télécommande et du tableau de commande.

 Après l'installation, vous devez fournir à l'utilisateur: **Manuel d'utilisation, garantie et diagnostic de pannes**.

 **L'équipement ne remplit pas la norme ADR.**

- 1 Démontez l'écrouille et les éléments de fixation et les remettez au client.

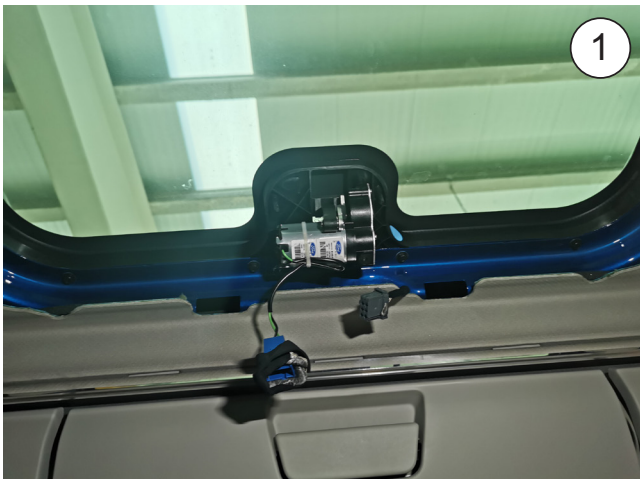
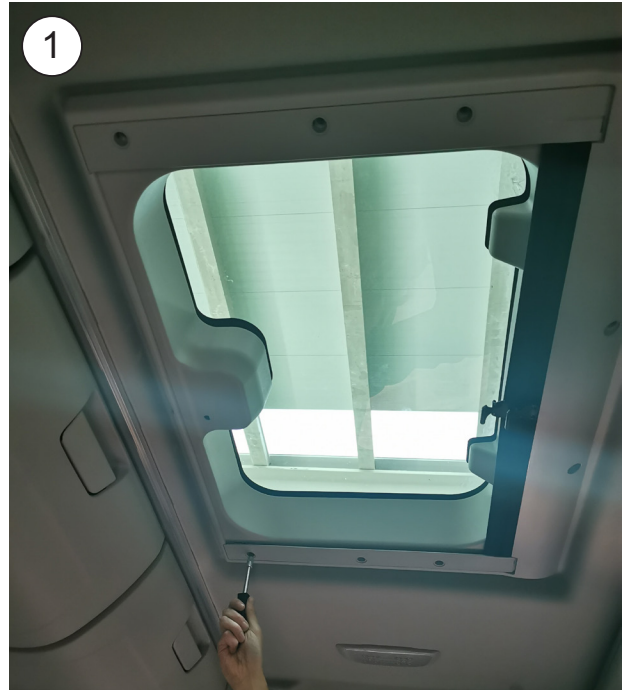

- 2** Coller le joint EPDM 30x25 autour du creux de l'écoutille (observer le détail pour couper les bords fins de l'union du joint).



**Attention:** Le joint EPDM doit être collé près du bord de l'espace de la trappe.

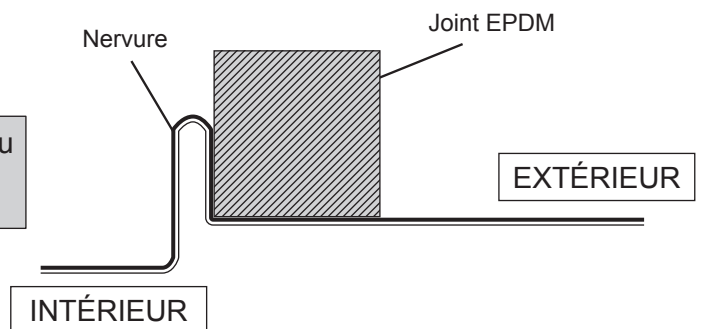

**COMMENT COUPER LE JOINT EPDM POUR ÉVITER LA FILTRATION D'EAU DANS LA CABINE**

- A-** Coller le joint et garder 100 mm de papier protecteur de chaque côté.
- B-** Retirer les deux pièces de papier.
- C-** Collez en exerçant une pression sur les deux extrémités.

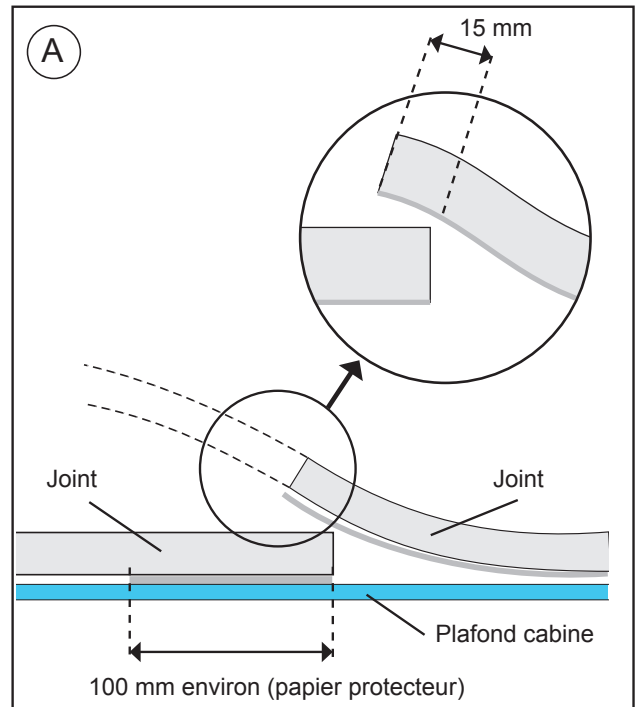

**(B)**

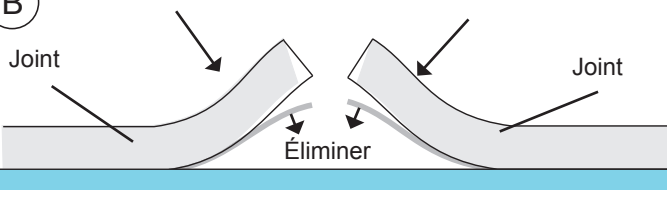

**(C)**

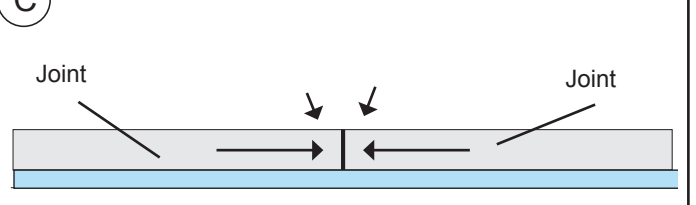

- 3** Positionner l'appareil sur le joint en introduisant le panneau intérieur de distribution dans l'espace de l'écouille.

**Attention !** Avant de placer l'équipement sur le creux de l'écouille, il faut vérifier que les sorties d'écoulement ne soient pas bouchées par le joint EPDM.

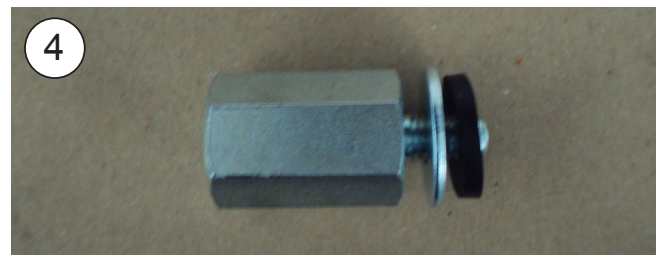

- 4** Visser (4) hexagones M8/125x26 avec une rondelle en caoutchouc, une rondelle plane sur les inserts de la base et serrer avec un couple de serrage de  $12,7 \pm 10$  Nm.

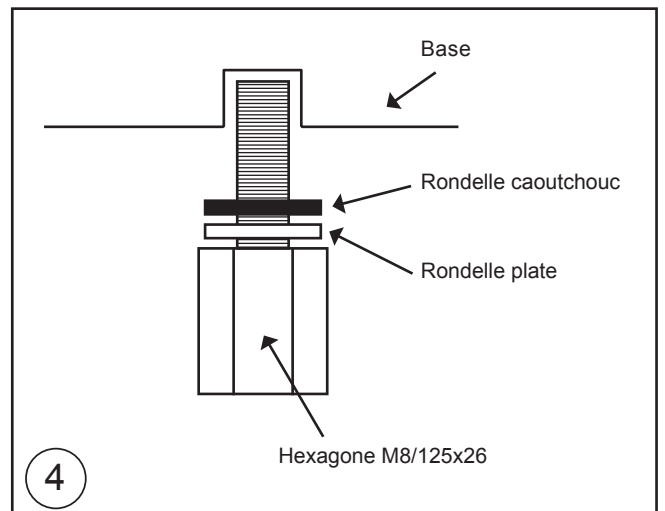

- 5** Placer les supports de fixation avec une rondelle plate, rondelle grower et vis M8/125x50 **sans serrer**.

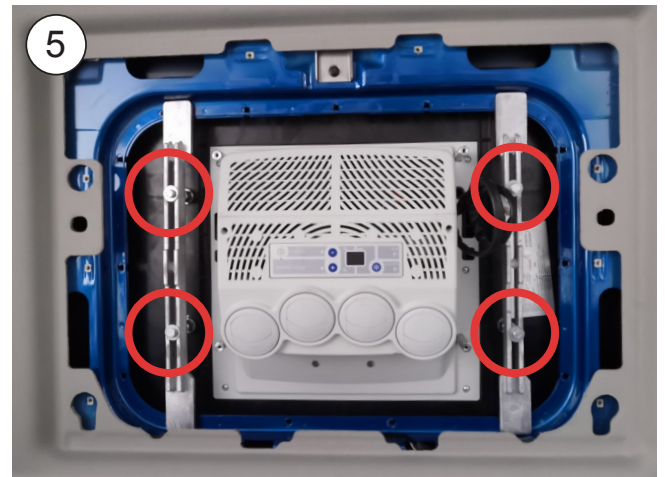

- 6** Visser (4) hexagones M6 L=94 et serrer avec un couple de serrage de  $4,75 \pm 10\%$  Nm, comme il est indiqué sur l'image.

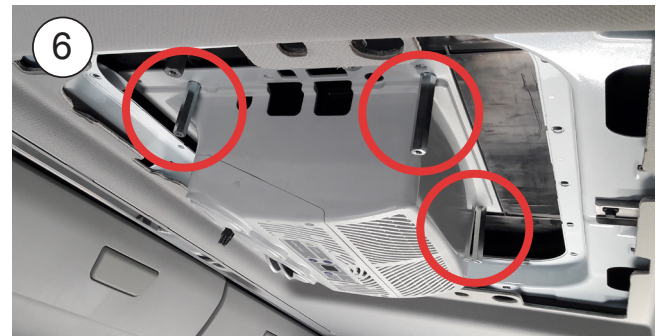

- 7** Présenter la console, tel que cela est indiqué sur l'image, et centrer l'équipement. Pour cela, il faudra vérifier que les rainures de la base ne sont pas visibles et sont soutenues sur le joint EPDM.



- 8** Retirer la console et serrer les vis M8/125x50 jusqu'à atteindre les hexagones pour fixer l'équipement.



- 9** Porter les câbles d'alimentation jusqu'à l'écouille et agraffer ces derniers aux terminaux fournis et placer le boîtier à 2 voies fourni.

**Attention :** faire coïncider les câbles tel que cela est indiqué R= (+) et N= (-).

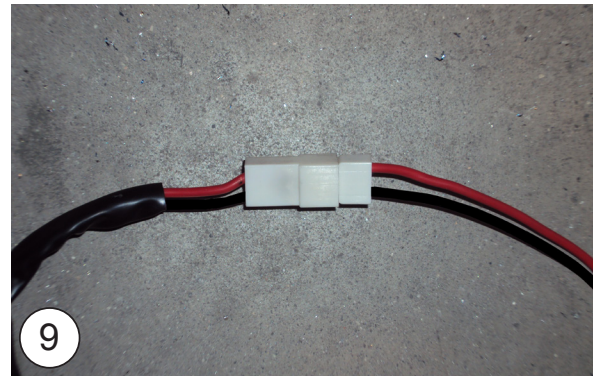

- 10** Placer la console avec (4) vis M6/100x15.

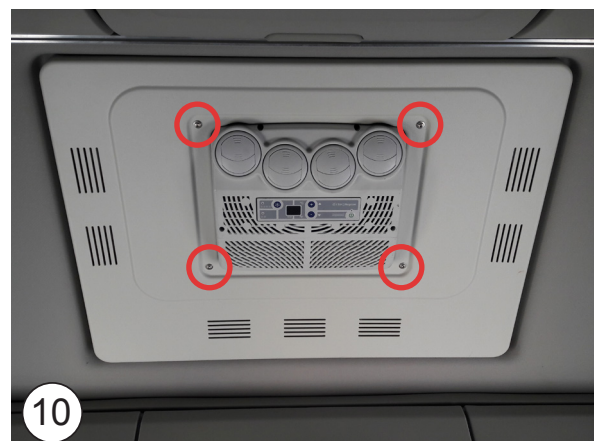

**Vue éclatée jusqu'à la fixation des supports**

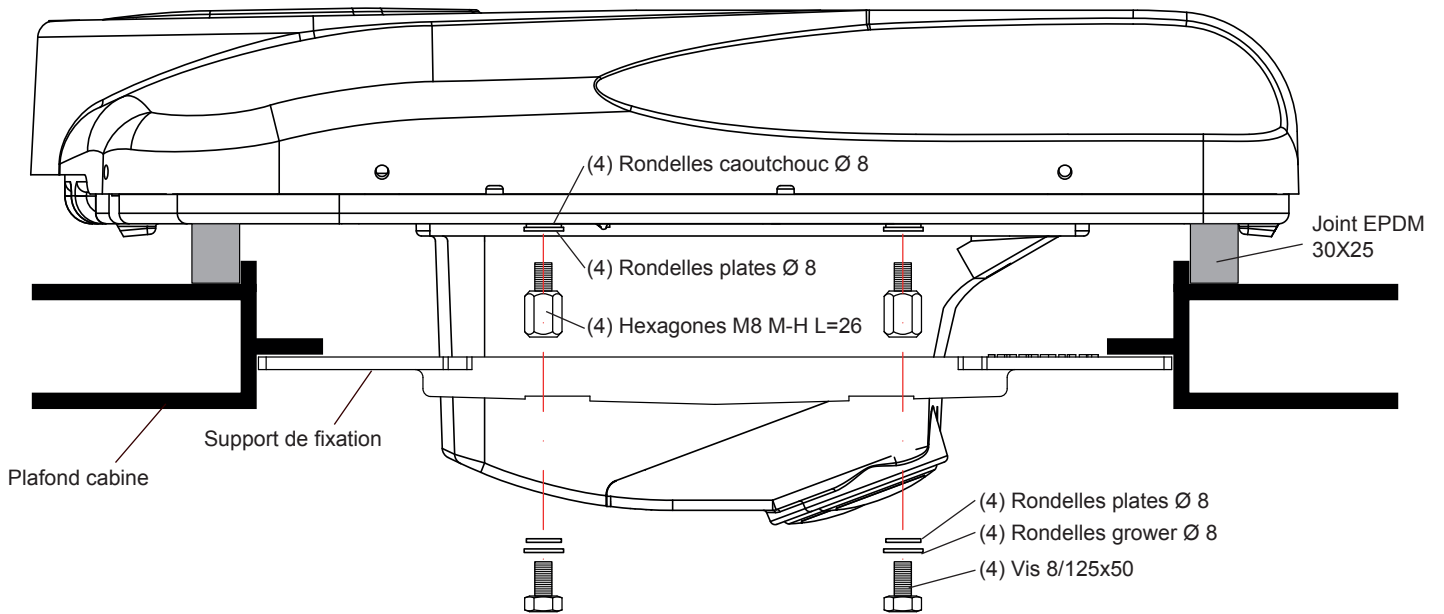

**Vue éclatée jusqu'à la fixation de console**





Schéma électrique

AVIS IMPORTANT !

**Attention** de ne pas inverser les polarités au moment de connecter l'équipement à la batterie. Si cela se produisait, la plaque de commande ne s'allumerait pas et l'équipement ne fonctionnerait pas.

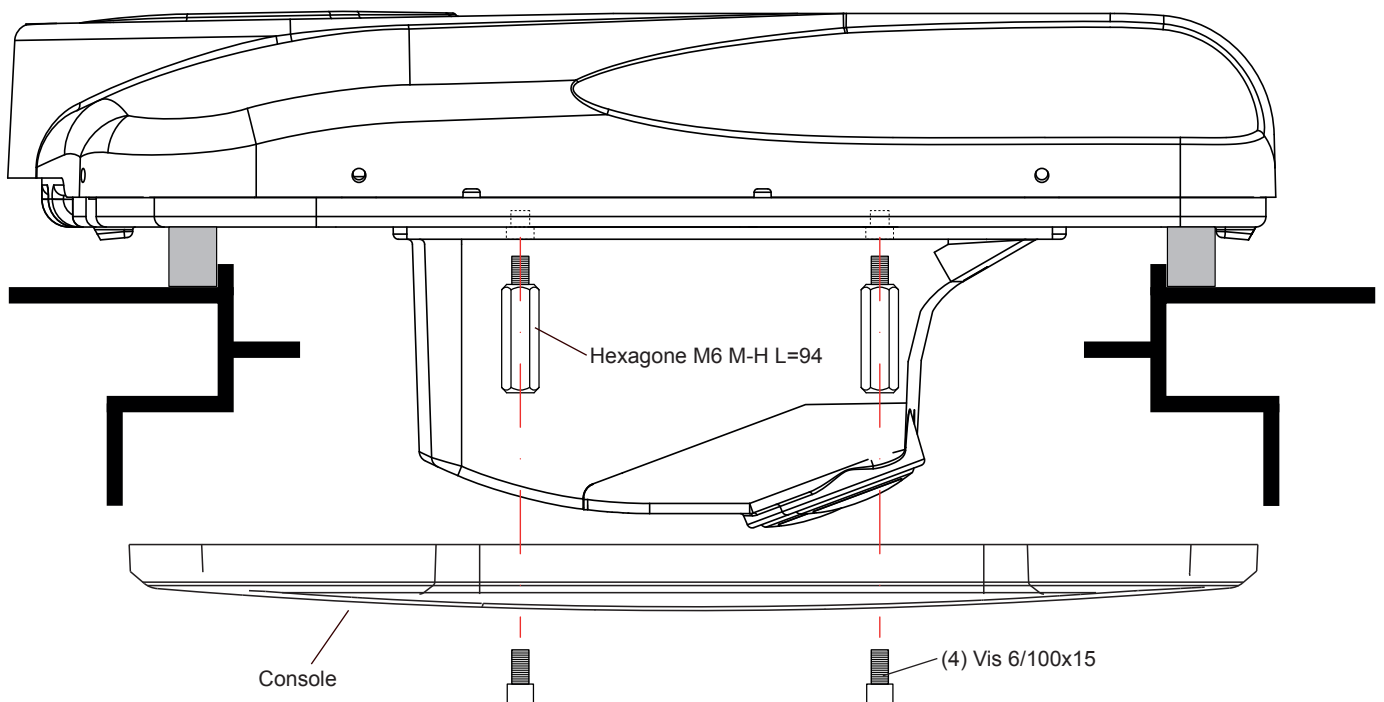
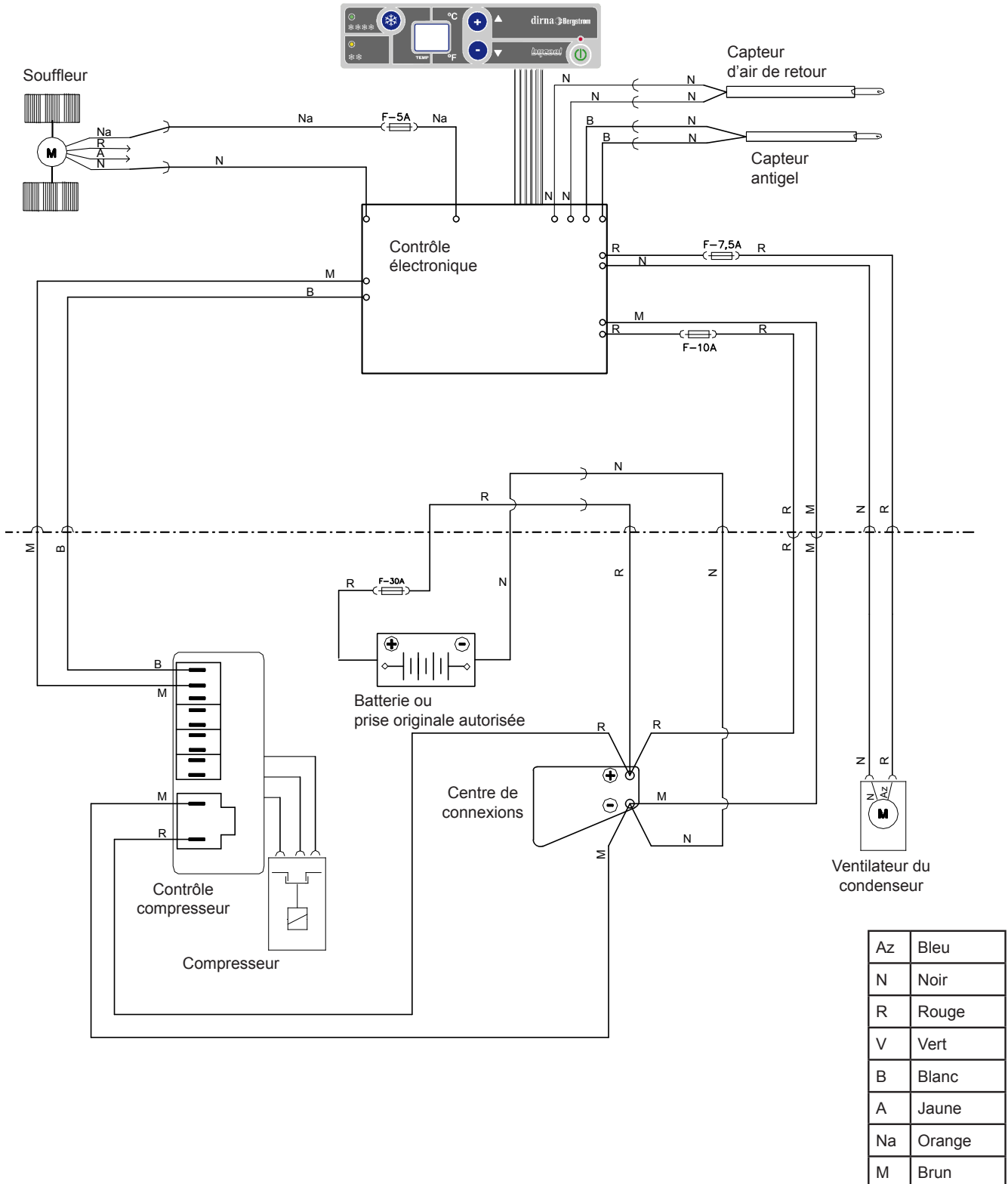

## Empfehlungen Zur montage

- Vor und während der Montage bitte diese Anweisungen lesen und beachten.
- Benutzen Sie für jeden Arbeitsschritt die geeigneten Werkzeuge.

## Elektrizität

- Zündschlüssel abziehen.
- Vor Montagebeginn die Batterie abklemmen.
- Den ordnungsgemäßen Anschluss und die korrekte Installation der Elektrokomponenten überprüfen.

## Achtung

Sollte sich das Gerät während der Montage neigen, muss man mindestens 60 Minuten warten, nachdem es wieder in die horizontale Lage gebracht wurde, um es wieder einzuschalten.

## Achtung

Wird die Klimaanlage im Kabinendach installiert, muss der obere Teil der Kabine mit einem Tuch oder einer Decke gegen eventuelle Kratzer geschützt werden. Bei der Installation der LITE auf dem Kabinendach muss darauf geachtet werden, dass mit Luken ausgestattete Kabinen über eine ausreichend stabile Struktur verfügen, um das Gewicht des Geräts stand zu halten. Sollte das Fahrzeug über keine Luke verfügen und sollte es notwendig sein, das Kabinendach aufzuschneiden, bzw. sollte die vorhandene Struktur nicht ausreichend stabil sein (z.B. wenn sie aus Faser, Kunststoff usw. hergestellt ist), obliegt es dem Installateur zu entscheiden, ob das Kabinendach zur Vermeidung von Verformungen, Brüchen, undichten Stellen usw. verstärkt werden muss, und die hierfür notwendigen Mittel bereit zu stellen.



## Werkzeuge

Torx-Schraubenschlüssel  
Inbusschraubenschlüssel  
10er, 13er, 14er Schraubenschlüssel  
Schere  
Metermaß  
Schraubendreher







## Zugehörige Dokumentation

Montageanweisungen	1002810223
Benutzerleitfaden	1001335089
Fehlerdiagnose	1001335088
Ersatzteilliste	1002810225

## Symbolik

-  Fragile
-  Achtung Gericht!
-  Elektrische Gefährdung

## Warnhinweise

-  Der Installateur muss im Bereich Fahrzeug-Klimaanlagen ausreichend geschult sein.
-  **Bergstrom** übernimmt keine Verantwortung für Schäden oder Brüche aufgrund einer nicht ordnungsgemäßen Installation oder Bedienung des Geräts oder den Austausch von Teilen bzw. Umbauten, die ohne die erforderliche schriftliche Genehmigung durchgeführt wurden.
-  **Mit Kältemittel vorgefülltes Gerät R-134a. (Kältemittelkreislauf nicht manipulieren).**
-  Siehe **Garantieverfahren** des Produkts in der **Fehlerdiagnose**.
-  Siehe **Benutzerleitfaden** des Geräts für den ordnungsgemäßen Betrieb der Fernbedienung und des Bedienfelds.
-  Die folgenden Unterlagen müssen dem Benutzer nach der Installation ausgehändigt werden: **Benutzerleitfaden, Garantie** und **Fehlerdiagnose**.
-  **Die Anlage erfüllt nicht die ADR-Vorschriften.**

- 1 Luke und deren Befestigungselemente ausbauen und diese dem Kunden aushändigen.

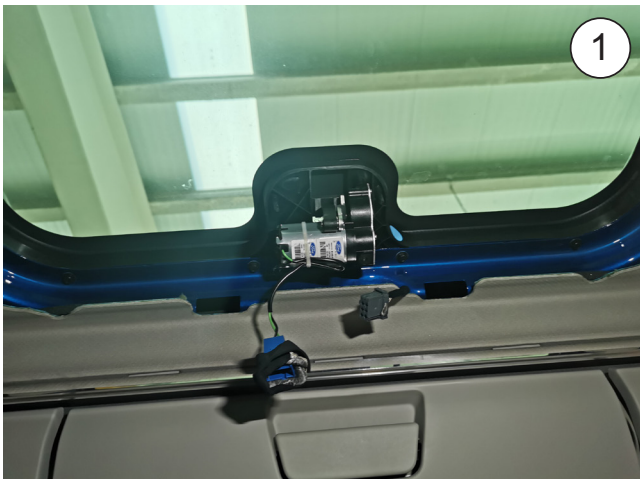
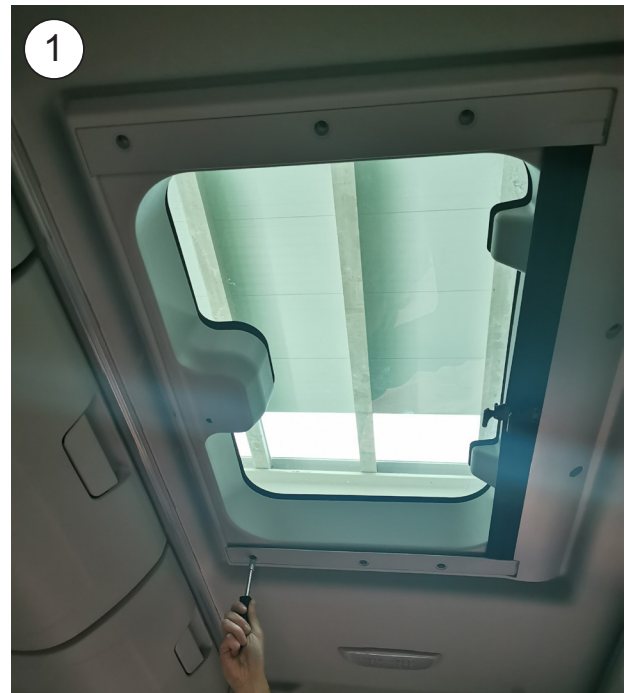

**2** EPDM-Dichtung (30x25 mm) um die Lukenausparung herum kleben (siehe Detailzeichnung für das Zurechtschneiden der äußeren Fugenränder der Dichtung).

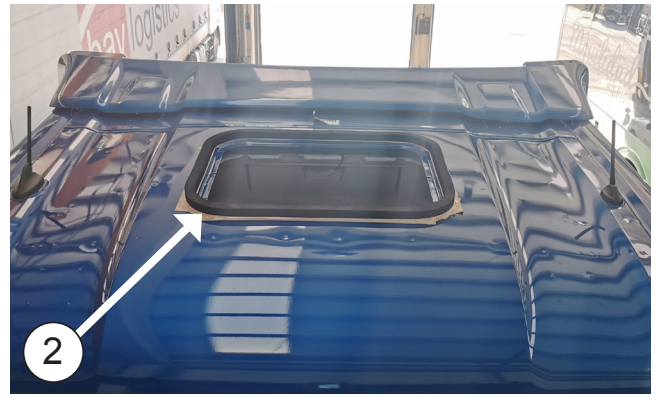

**!** **Achtung:** Die EPDM-Dichtung muss am Vorsprung der Lukenausparung angeklebt sein.

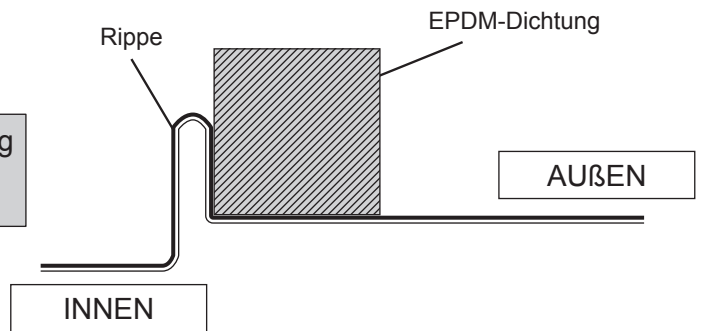

**WIE DIE EPDM-DICHTUNG GESCHNITTEN A WIRD, UM FILTRATIONEN IN DER KABINE ZU VERMEIDEN**

- A-** Dichtung aufkleben und dabei einen Papierschutz von 100 mm auf jeder Seite beibehalten.
- B-** Die zwei Papierstücke entfernen.
- C-** Unter Anpressen beider Enden aufkleben.

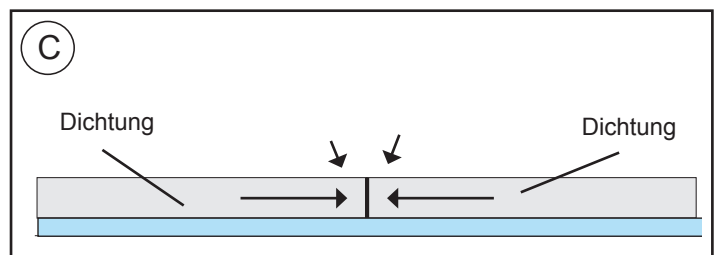
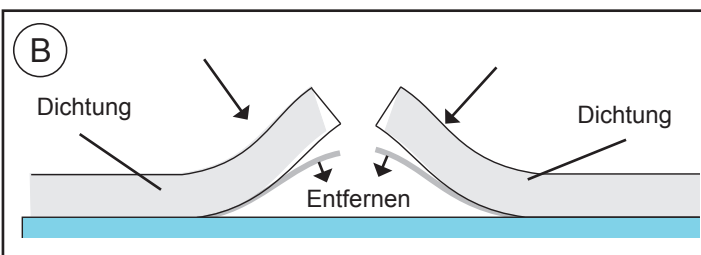
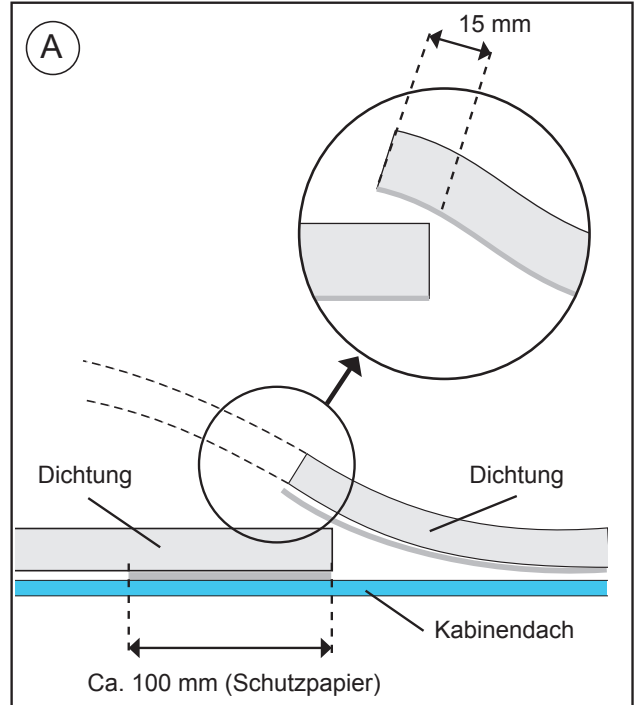

- 3** Anlage auf die Dichtung legen und die innere Luftverteiltertafel durch die Lukenöffnung stecken.

**Achtung! Beim Auflegen des Geräts auf die Lukenausparung darauf achten, dass die Entwässerungsausgänge nicht von der EPDM-Dichtung zusammengedrückt werden.**



- 4** (4) Sechskant-Verbindungsmuttern M8/125x26 mit Gummi-Unterlegscheibe und Flachscheibe in die Einsätze der Grundplatte einschrauben und mit einem Anzugsmoment von  $12,7 \pm 10$  Nm anziehen.

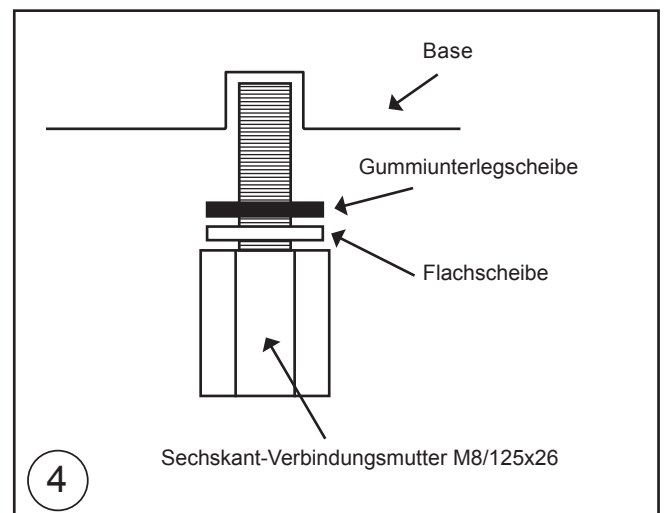

**5** Befestigungshalterungen mit Flachscheibe, Grower-Scheibe und Schraube M8/125x50 einsetzen ohne anzuziehen.

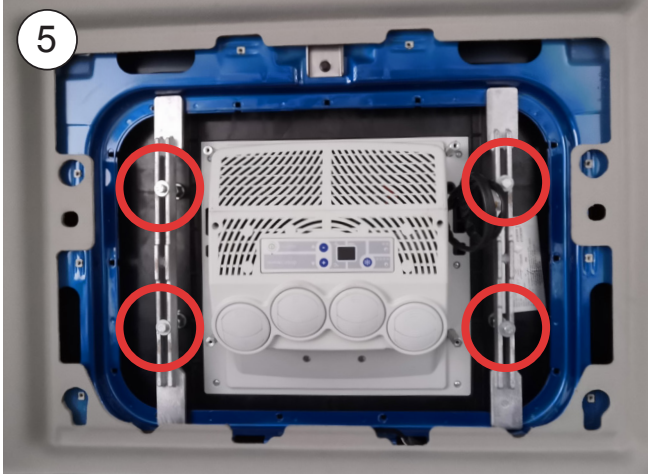

**6** (4) Sechskant-Abstandshalter M6 L=94 eindrehen und auf  $4,75 \pm 10\%$  Nm anziehen (siehe Abbildung).

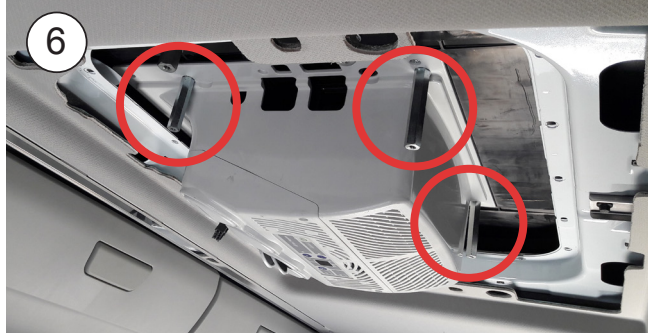

**7** Konsole wie in der Abbildung gezeigt auflegen und das Gerät zentrieren. Hierfür prüfen, dass die Rillen der Grundplatte nicht zu sehen sind und auf der EPDM-Dichtung aufliegen.



- 8** Konsole abnehmen und Schrauben M8/125x50 bis zum Anschlag an die Sechskant-Abstandshalter anziehen, um das Gerät zu befestigen.



- 9** Netzkabel zur Luke führen, die mitgelieferten Kabelschuhe daran heften und den mitgelieferten 2-Wege-Kasten anbringen.

**Achtung:** Die Kabel müssen wie angegeben übereinstimmen: R= (+) und S= (-).

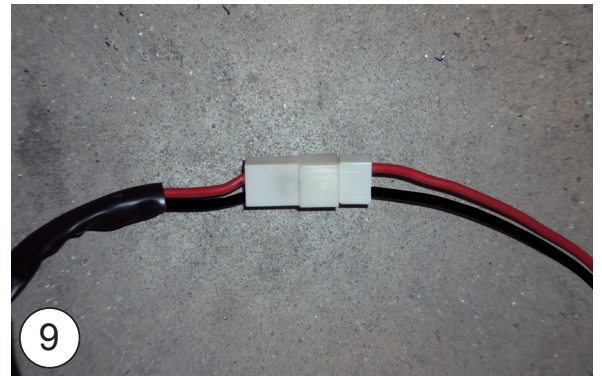

- 10** Konsole mit (4) Schrauben M6/100x15 anbringen.

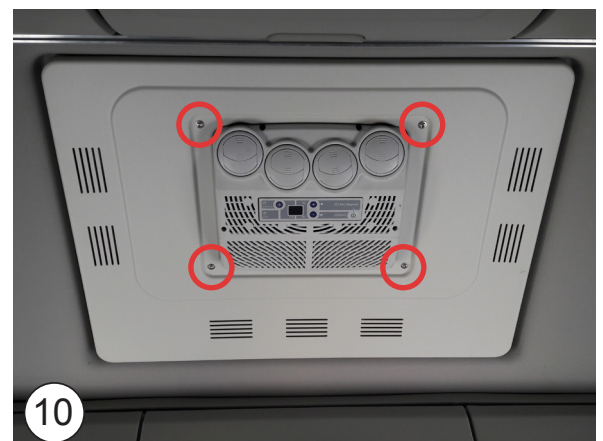

### Explosionsansicht bis zur befestigung der halterungen

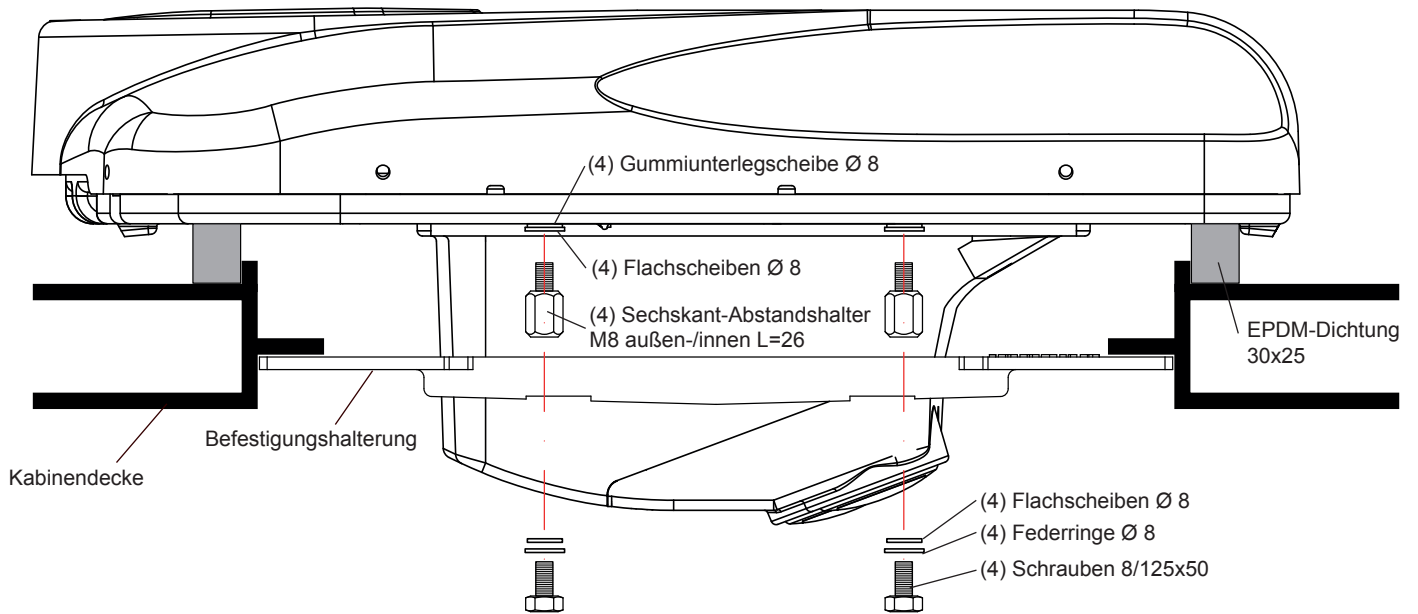

### Seitliche explosionsansicht bis zur befestigung der konsolen

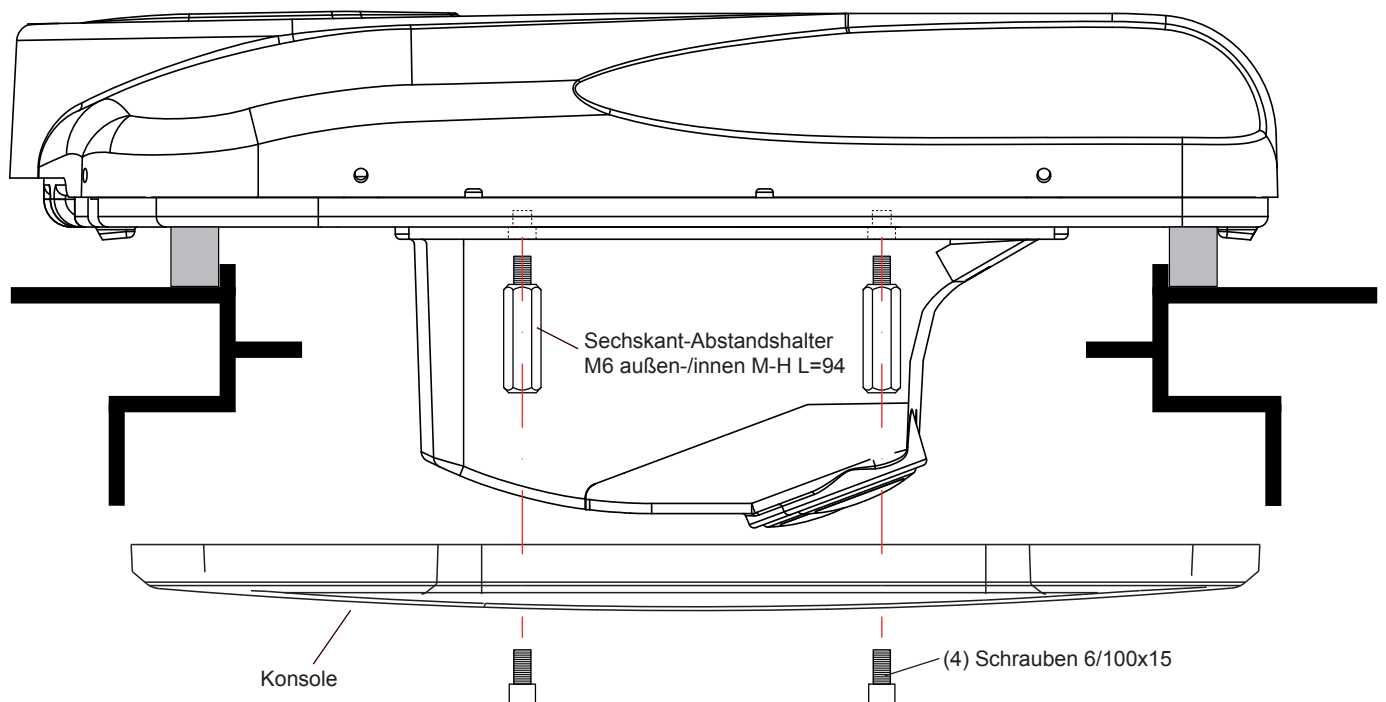



**WICHTIGER HINWEIS!**

**Achtung:** Die Polaritäten beim Anschluss des Geräts an die Batterie nicht invertieren. Ist dies der Fall, schaltet sich die Bedientafel nicht ein und das Gerät funktioniert nicht.

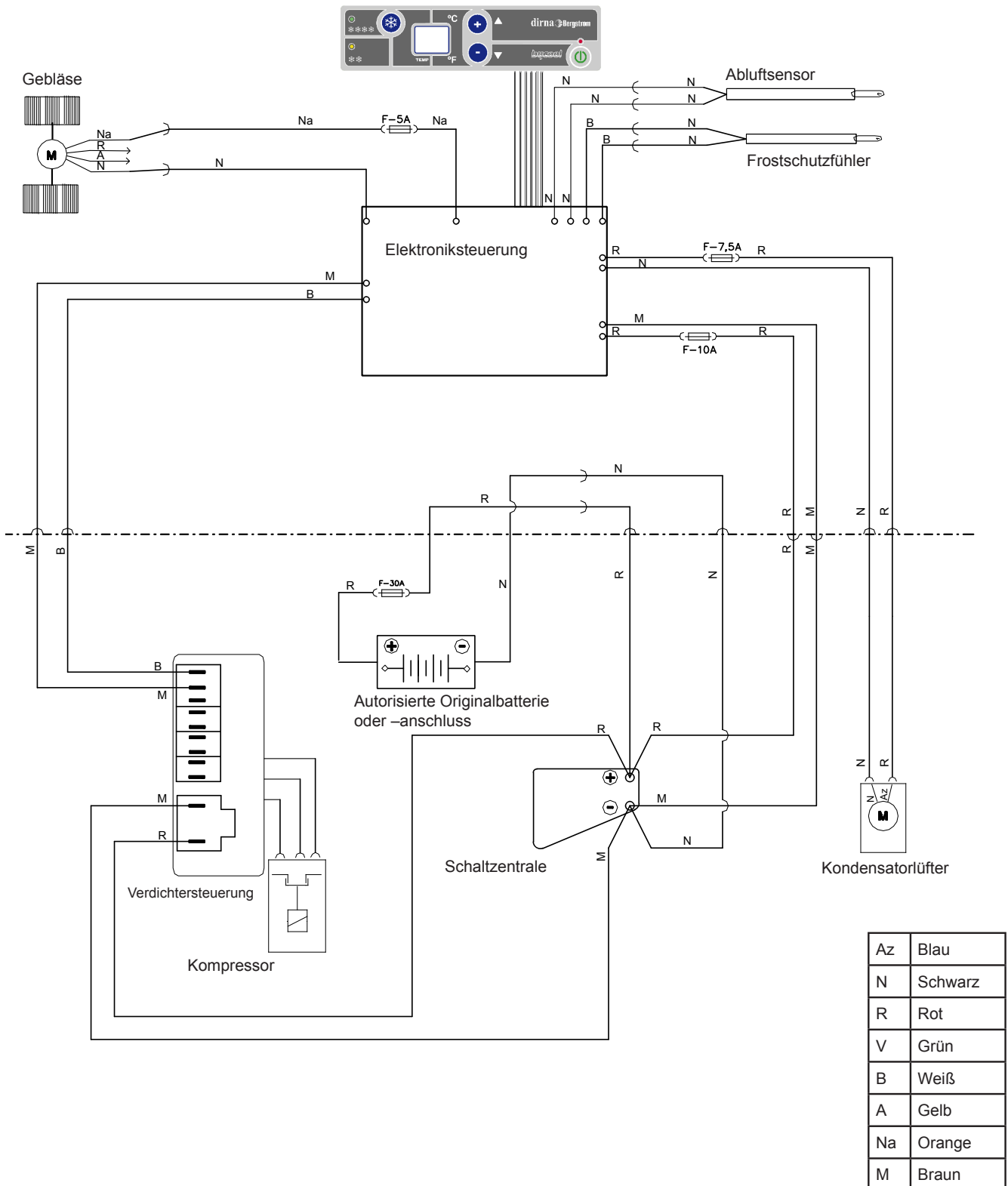

## Suggerimenti per il montaggio

- Prima di cominciare il montaggio, leggere attentamente le istruzioni e rispettarle nel corso dello stesso.
- Usare gli attrezzi più adatti ad ogni operazione.

## Elettricità

- Scollegare la chiave di contatto.
- Scollegare la batteria prima di cominciare il montaggio.
- Assicurarsi di aver effettuato correttamente l'installazione e il collegamento dei componenti elettrici.

## Attenzione

Se durante il montaggio si inclina l'impianto, prima di rimetterlo in funzione occorre attendere almeno 60 minuti dal momento in cui è di nuovo in posizione orizzontale.

## Attenzione

Quando si installa l'impianto di aria condizionata sul tettuccio, bisogna proteggere la parte superiore della cabina con uno straccio o una coperta per evitare eventuali graffi. Per l'installazione del LITE, tenere presente che normalmente le cabine munite di oblò dispongono di una struttura abbastanza solida per sostenere il peso dell'impianto. Tuttavia, se così non fosse e se fosse necessario tagliare il tettuccio, o se in presenza di oblò la struttura non fosse abbastanza rigida (se fosse di fibra, plastica, ecc.), è responsabilità dell'installatore decidere se occorre rinforzare il tettuccio per evitare qualsiasi deformazione, rottura o penetrazione d'acqua, ecc., prendendo le misure necessarie per evitarlo.

## Attrezzi

Kit di chiavi Torx  
 Kit di chiavi Allen  
 Chiave fissa 10, 13, 14  
 Forbici  
 Metro a nastro  
 Cacciavite

## Documenti correlati

Istruzioni di montaggio	1002810223
Guida dell'utente	1001335089
Soluzione dei problemi	1001335088
Elenco ricambi	1002810225

## Simbologia



Fragile





Attenzione alle mani





Tensione elettrica pericolosa

## Avvertenze

 L'installatore deve essere in possesso della formazione necessaria in materia di aria condizionata per veicoli.

 **Bergstrom** declina ogni responsabilità per danni o rotture derivanti dall'errata installazione o dall'errato uso dell'impianto o da sostituzioni o modifiche effettuate senza la necessaria autorizzazione per iscritto.

 **Impianto precaricato con gas refrigerante R-134. (Non manomettere il circuito di gas refrigerante).**

 Vedi la **procedura di garanzia** del prodotto in **Diagnosi dei problemi**.

 Vedi la **Guida dell'utente** dell'impianto per il corretto funzionamento del telecomando e del pannello di controllo.

 I seguenti documenti devono essere consegnati all'utente una volta conclusa l'installazione: **Guida dell'utente, Garanzia e Diagnosi dei problemi**.

 **L'impianto non è conforme alla normativa ADR.**

- 1 Smontare il coperchio del tettuccio apribile e gli elementi di fissaggio e consegnarli al cliente.

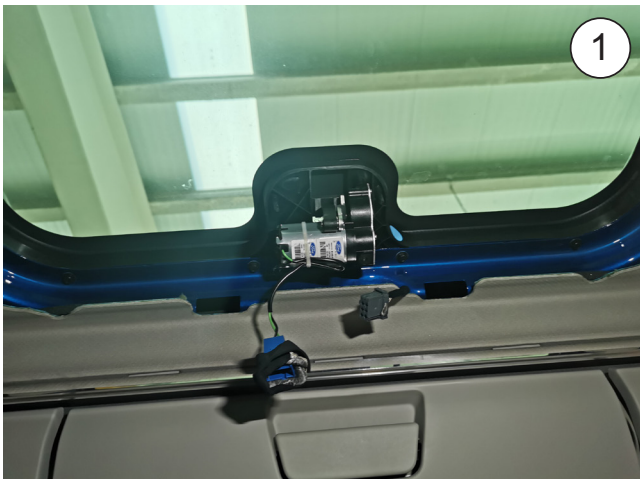

**2** Incollare la guarnizione EPDM 30x25 intorno al vano del tettuccio apribile (vedi il particolare per tagliare i bordi finali di attacco della guarnizione).

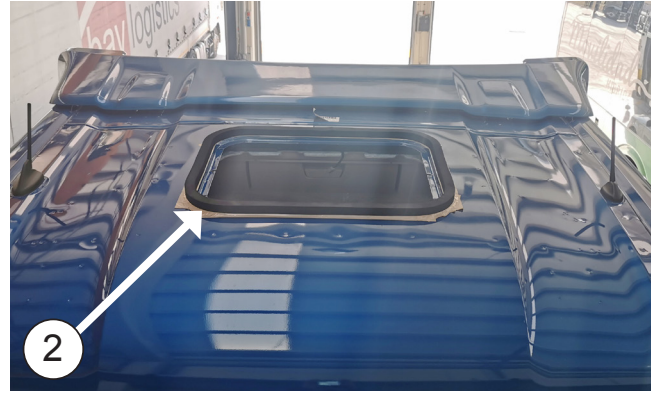

**Attenzione:** Incollare la guarnizione EPDM accanto alla sporgenza del vano del tettuccio apribile.

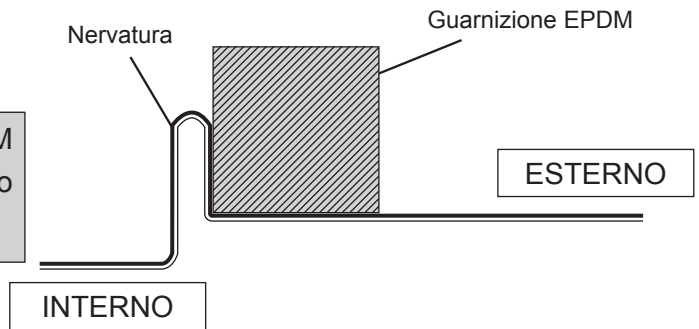

**INCOLLARE LA GUARNIZIONE EPDM INTORNO A AL FORO DELL'OBLO' (VEDI PARTICOLARE PER TAGLIARE I BORDI)**

**A-** Incollare la guarnizione mantenendo una protezione di carta di 100 mm su ogni lato.

**B-** Rimuovere i due pezzi di carta.

**C-** Incollare premendo su entrambe le estremità.

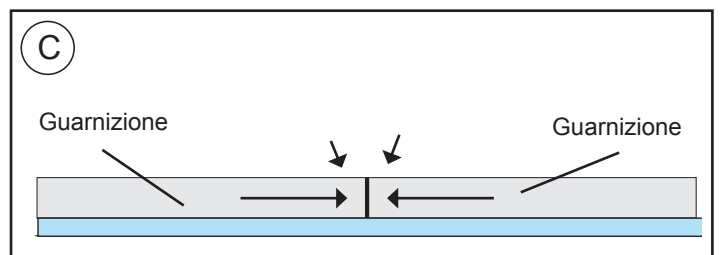
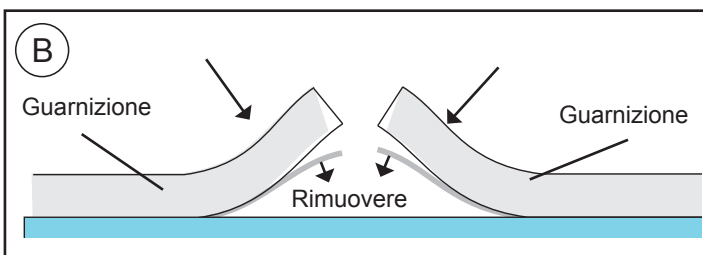
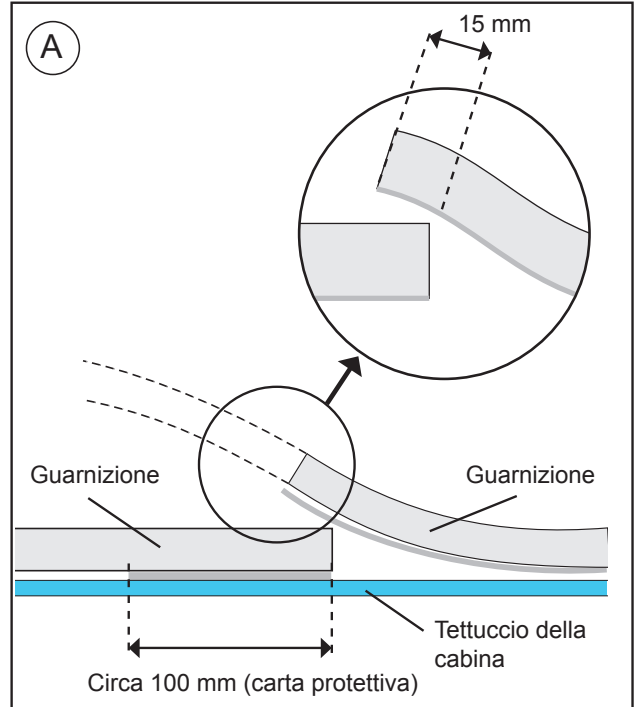

- 3** Sistemare l'impianto sulla guarnizione inserendo il pannello interno di distribuzione nel vano del tettuccio apribile.

**Attenzione!** Quando si sistema l'impianto sul vano del tettuccio apribile, verificare che le uscite di scarico non siano ostruite dalla guarnizione EPDM.



- 4** Avvitare (4) perni esagonali M8/125x26 con rondella di gomma e rondella piana sugli inserti della base e stringere con una coppia di serraggio di  $12,7 \pm 10$  Nm.

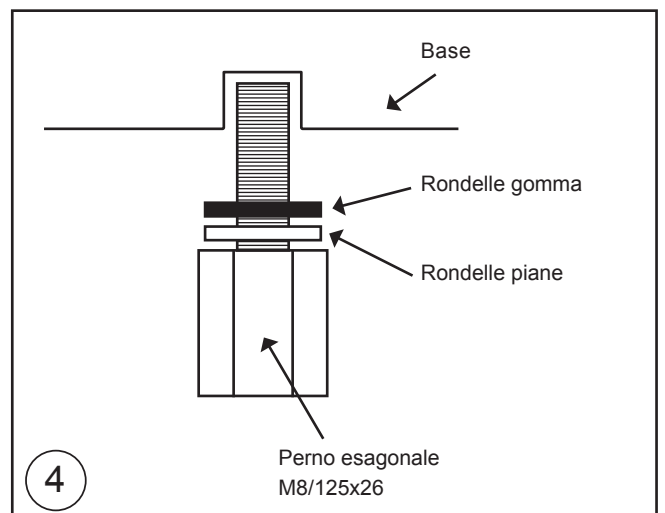

- 5** Inserire i supporti di fissaggio con rondella piana, rondella grower e vite M8/125x50, **senza stringere**.

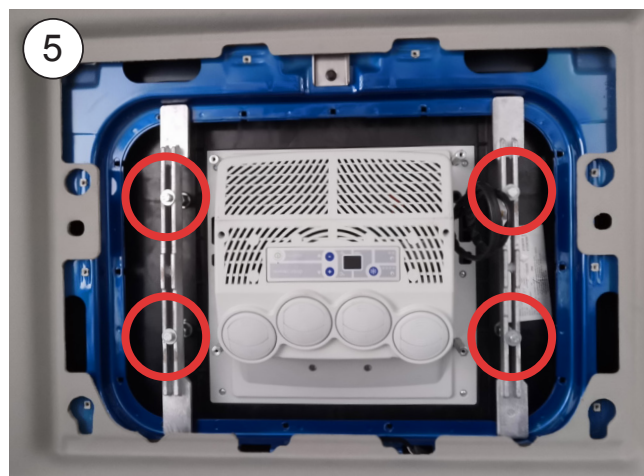

- 6** Avvitare (4) perni esagonali M6 L=94 e stringere con una coppia di serraggio di  $4,75 \pm 10\%$  Nm, come indicato nella figura.

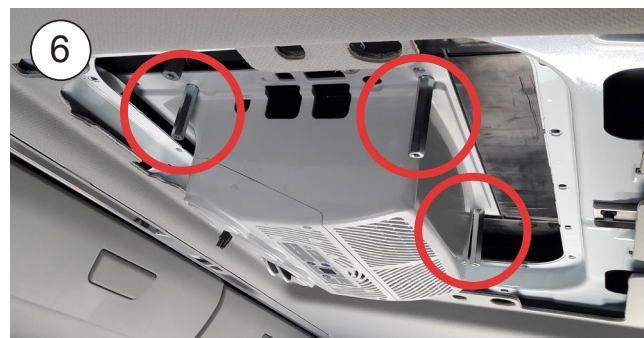

- 7** Sistemare provvisoriamente la console, come indicato nella figura, e centrare l'impianto. Nel farlo, verificare che le scanalature della base non siano visibili, restando appoggiate sulla guarnizione EPDM.



- 8** Rimuovere la console e stringere le viti M8/125x50 fino a battuta con i perni esagonali per fissare l'impianto.



- 9** Condurre i cavi di alimentazione fino al tettuccio apribile e aggraffarvi i terminali in dotazione, quindi montare la scatola a 2 vie in dotazione.

**Attenzione:** fare coincidere i cavi come indicato, R= (+) e N= (-).

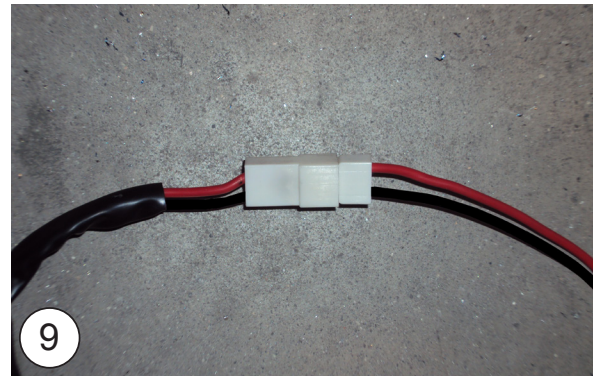

- 10** Fissare la console con (4) viti M6/100x15.

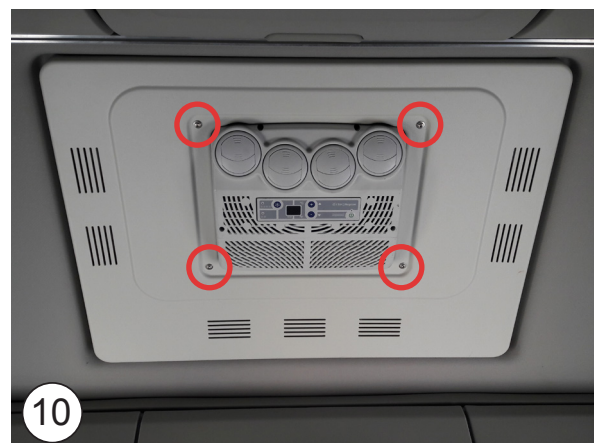

### Esploso fino al fissaggio dei supporti

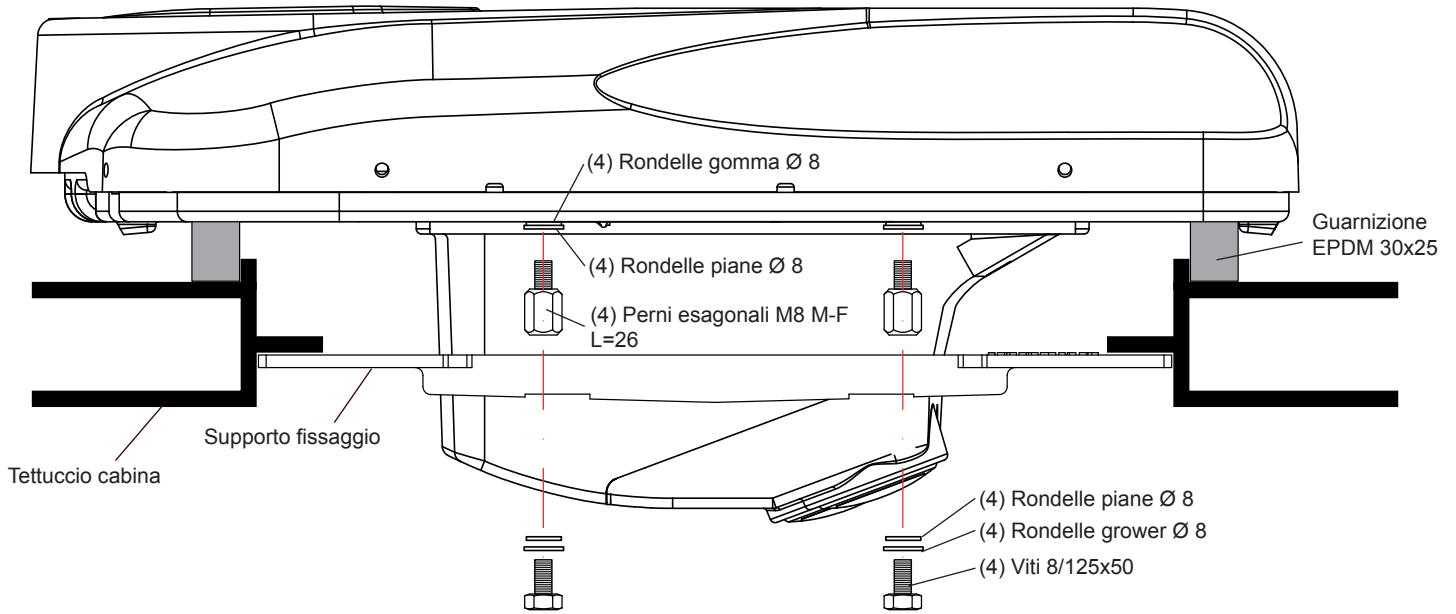

### Esploso laterale fino al fissaggio delle console

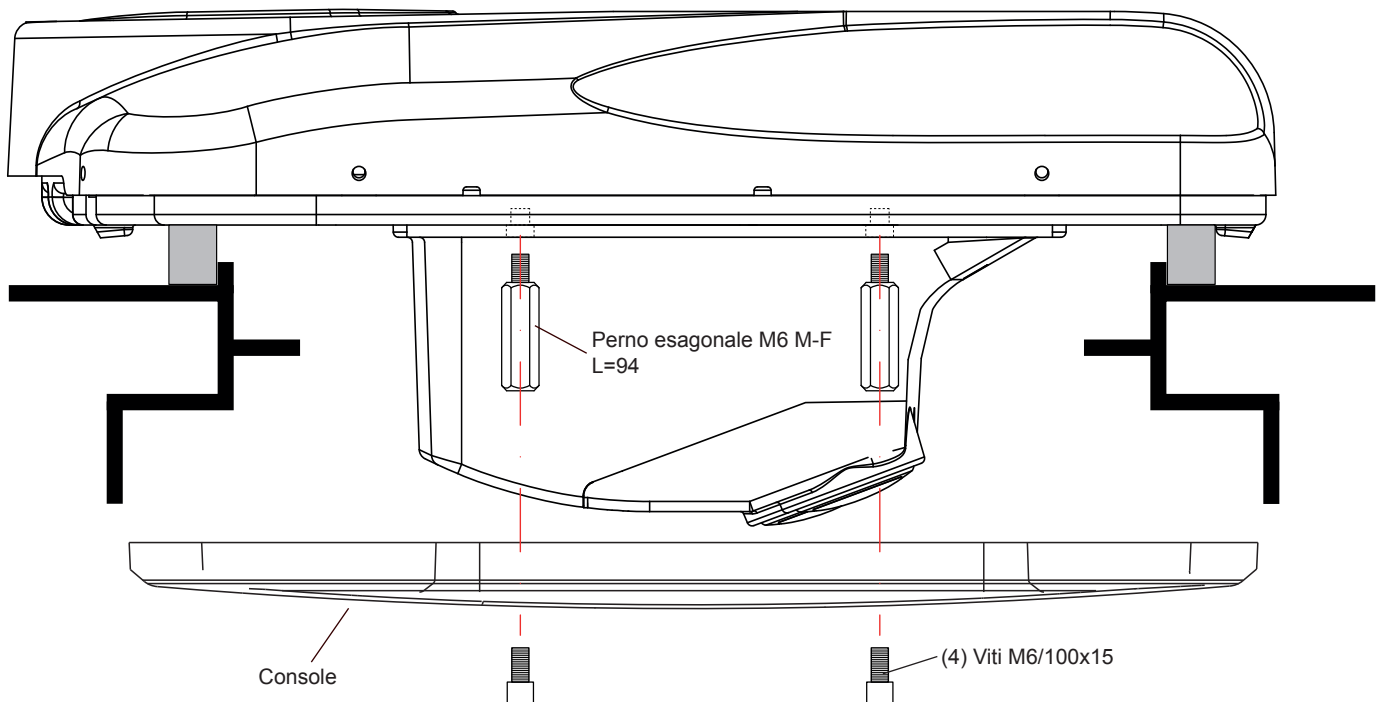



**AVVERTENZA IMPORTANTE!**

**Fare attenzione** a non invertire le polarità quando si esegue il collegamento dell'impianto alla batteria. Infatti, in tal caso il quadro comandi non si accende e l'impianto non funziona.

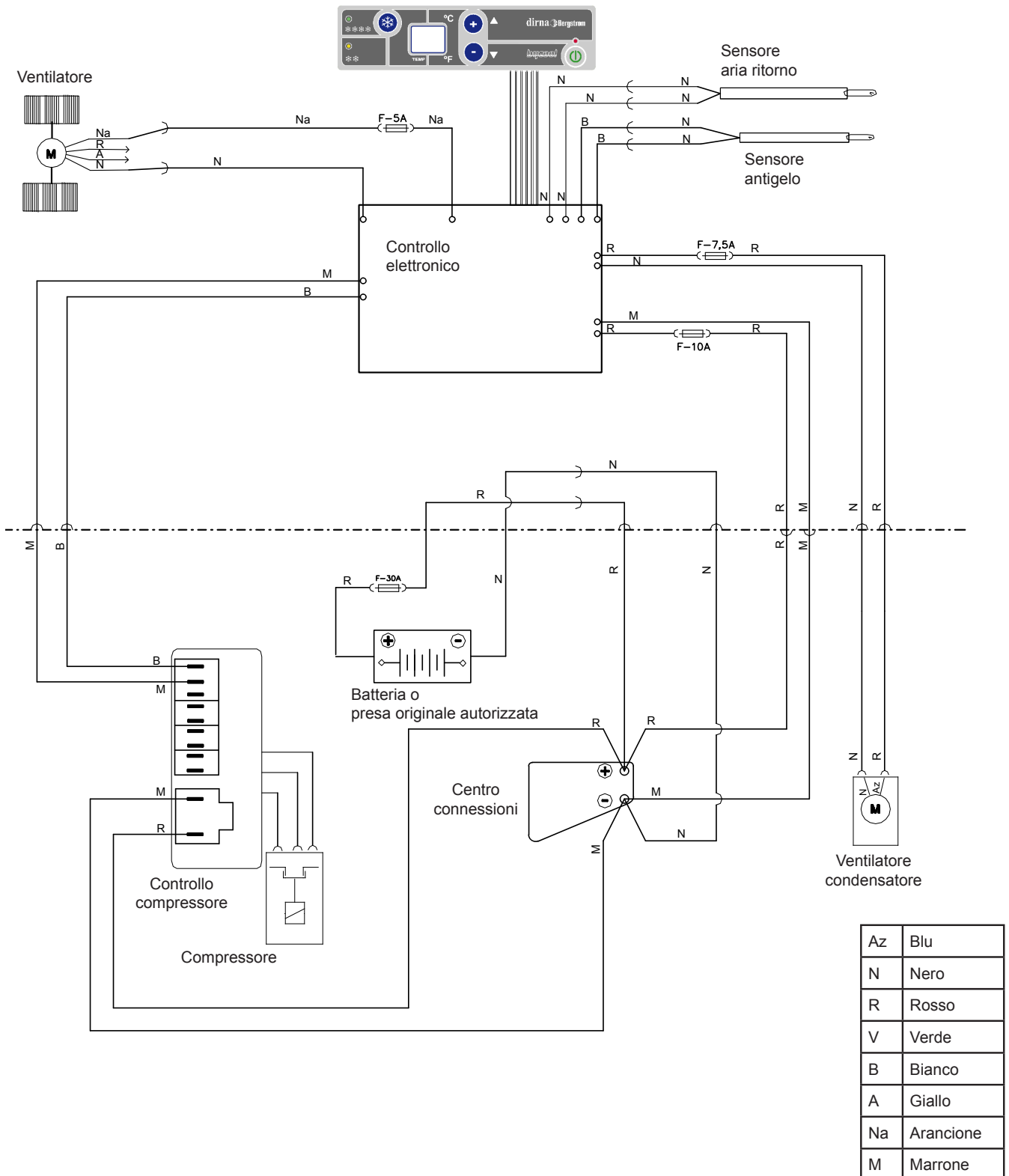







Francisco Alonso, 6  
28806 Alcalá de Henares, Madrid  
SPAIN

Ed:	18/12/2020
Md:	

Contact	Phone	E-Mail
Sales (Ventas Internacional)	+34 91 8770510	sales@dirna.bergstrominc.com
Comercial Nacional	+34 91 8775841	ventas@dirna.bergstrominc.com
Orders & Deliveries (Logística internacional)	+34 91 8775846	export@dirna.bergstrominc.com
Orders & Deliveries (Logística nacional)	+34 91 8775840	pedidos@dirna.bergstrominc.com
Technical Assistance (Internacional)	+49 511 86679681	technicalassistance@dirna.bergstrominc.com
Technical Assistance (Nacional)	+34 91 8775845	oblanco@dirna.bergstrominc.com

[www.dirna.com](http://www.dirna.com)

	<b>ATENCIÓN:</b>	Bergstrom se reserva el derecho de efectuar modificaciones en cualquier momento de los datos contenidos en esta publicación, por razones técnicas o comerciales.
	<b>NOTE:</b>	<i>For technical and commercial reasons, Bergstrom reserves the right to change the data contained in this brochure.</i>
	<b>ATTENTION:</b>	Bergstrom se réserve le droit d'effectuer à tout moment des modifications des données reprises sur cette publication, pour des raisons techniques ou commerciales.
	<b>HIWEIS:</b>	<i>Bergstrom behält sich vor, aus technischen oder kaufmännischen Gründen jederzeit Änderungen der Angaben dieser Veröffentlichung vorzunehmen.</i>
	<b>ATTENZIONE:</b>	Bergstrom si riserva il diritto di effettuare modifiche in qualsiasi momento ai dati contenuti in questa pubblicazione, per motivi tecnici o commerciali.