

bycool!
green line

COMPACT 3.0

RENAULT



Instrucciones de Montaje

Mounting Instructions

Instructions de Montage

Montageanweisungen

Istruzioni di Montaggio

ES Spanish

EN English

FR French

GE German

IT Italian

Recomendaciones Para el montaje

- Antes de iniciar el montaje leer las instrucciones y seguirlas durante el proceso de instalación.
- Usar las herramientas adecuadas para cada operación.

Electricidad

- Desconectar la llave de contacto.
- Desconectar la batería antes de empezar el montaje.
- Asegurar el conexionado de los componentes eléctricos, verificando su correcto encaje.

Atención

Si durante el montaje el equipo se inclina o se abate la cabina con el equipo montado, se deberá esperar un mínimo de 60 minutos, desde que el equipo quede horizontal, antes de ponerlo en marcha.

Atención

Al instalar el equipo de aire acondicionado en el techo se debe proteger la parte superior de la cabina con un paño o manta protectora para evitar posibles arañazos. Al instalar **Compact** en el techo hay que tener en cuenta que, normalmente, las cabinas que vienen provistas de escotilla, tienen una estructura suficiente para soportar el peso del equipo. Sin embargo, cuando no ocurra así y sea necesario realizar corte en el techo o incluso si en el caso de llevar escotilla el material no es lo suficientemente resistente (caso de techo de fibra, plástico, etc...) es el instalador el que debe decidir, **bajo su responsabilidad**, sobre la necesidad de reforzar el techo para evitar posibles deformaciones, roturas, entradas de agua, etc... habilitando los medios para que esto no ocurra.

Herramientas

Juego de Llaves Torx

Juego de Llaves Allen

Llave fija 10, 13, 14

Tijeras

Flexómetro

Documentación incluida

Instrucciones de montaje 1001443781

Manual del usuario 1001218019

Diagnóstico de averías 1001218025

Garantía 220AA10017

Simbología



Frágil





Atención corte!





Riesgo eléctrico

Advertencias

 El personal instalador debe poseer una formación suficiente en Aire Acondicionado de vehículos.

 **dirna Bergstrom, s.l.** queda exenta de responsabilidad si se producen averías que procedan de una inadecuada manipulación o instalación del equipo, o por modificaciones y sustituciones efectuadas sin nuestra expresa autorización por escrito.

 **Equipo precargado con gas** refrigerante R-134a. **(No manipular el circuito de gas refrigerante).**

 Véase **procedimiento de garantía** del producto incluido en **Diagnóstico de Averías**.

 Véase **Manual de Usuario** del equipo para el correcto funcionamiento del mando a distancia y del panel de control.

 Al finalizar la instalación se debe entregar al usuario: **Manual del Usuario, Garantía y Diagnóstico de averías.**

 Antes de empezar con el montaje, montar rejilla entrada aire delantera.



1 Desmontar tapa escotilla, los elementos de fijación y entregar al cliente.



2 Quitar los residuos sobrantes adheridos al techo antes de pegar la junta EPDM.

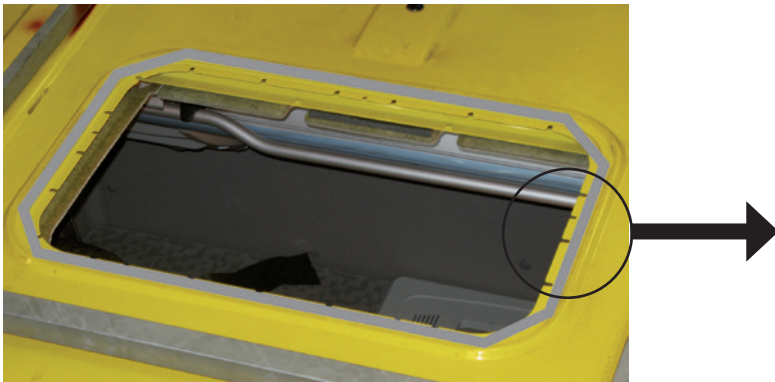
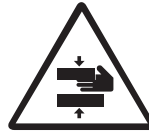

3 Pegue la junta EPDM alrededor del resalte del hueco de la escotilla (mirar el detalle para cortar los bordes finales de unión de la junta).





COMO CORTAR LA JUNTA EPDM PARA EVITAR FILTRACIÓN DE AGUA EN LA CABINA

- A- Pegar la junta, manteniendo 100 mm de papel protector por cada lado.
- B- Quitar los dos piezas de papel.
- C- Pegue presionado ambos finales.

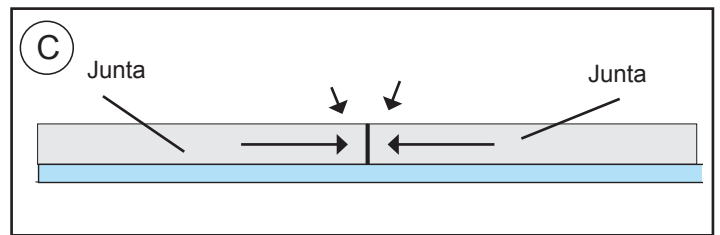
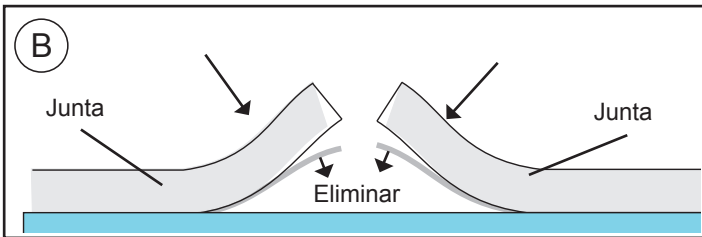
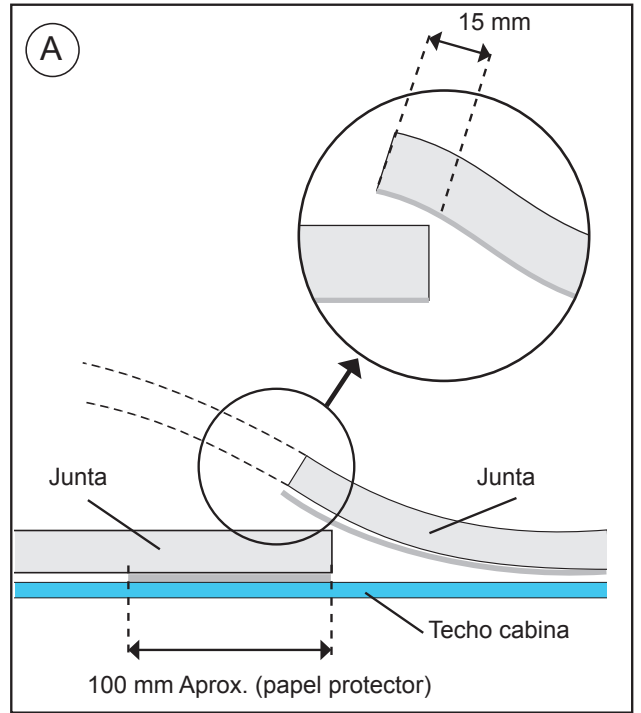

4

EXTERIOR CABINA:

Posicionar el Compact en el hueco de la escotilla.

¡Atención! Al colocar el equipo encima del hueco escotilla, revisar que las salidas de desagüe no queden obstruidas por la junta EPDM.



5

Colocar canalizador gomaespuma quedando la parte más blanda en la base del equipo.

Atención: Dependiendo de la cabina, es posible que sea necesario usar los (2) canalizadores suministrados para que el panel de distribución de aire quede totalmente ajustado con ellos.



6 **INTERIOR CABINA:**
 Roscar 5 mm aproximadamente (4) espárragos 8/125x100-70 ó 120, la medida se elegirá tras presentar los soportes de sujeción y teniendo en cuenta que los espárragos deben sobresalir de los mismos por la parte inferior unos 20 mm.

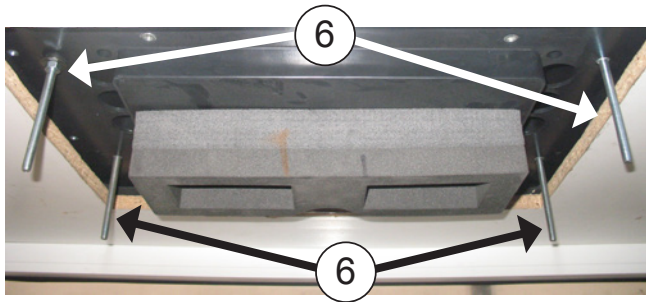
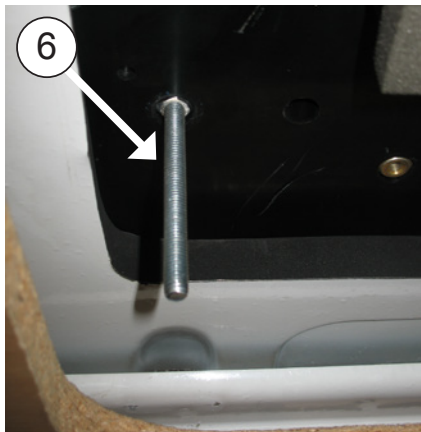
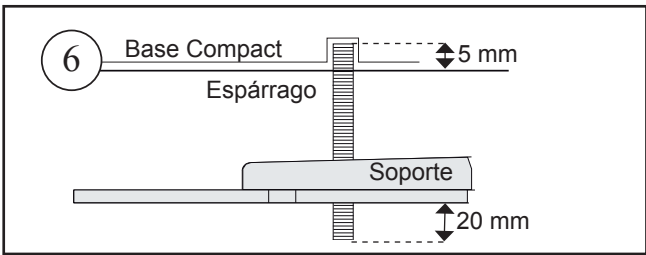

7 Colocar (1) arandela Ø 7 de goma, (1) arandela plana Ø 8 ala ancha, (2) tuerca M8 y (1) arandela plana Ø 8 ala ancha , en cada uno de los espárragos anteriores; siguiendo dicho orden.

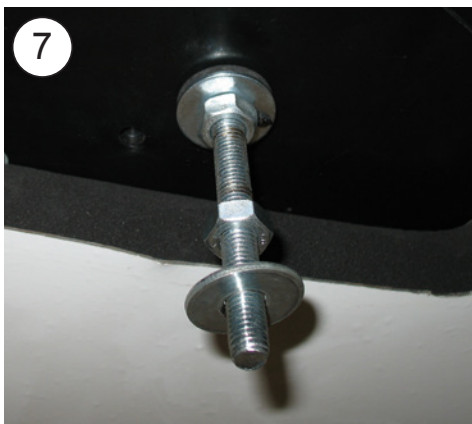

8 Colocar (2) soportes sujeción, con (1) arandela y (1) tuerca autoblocante M8, **sin llegar a apretar.**

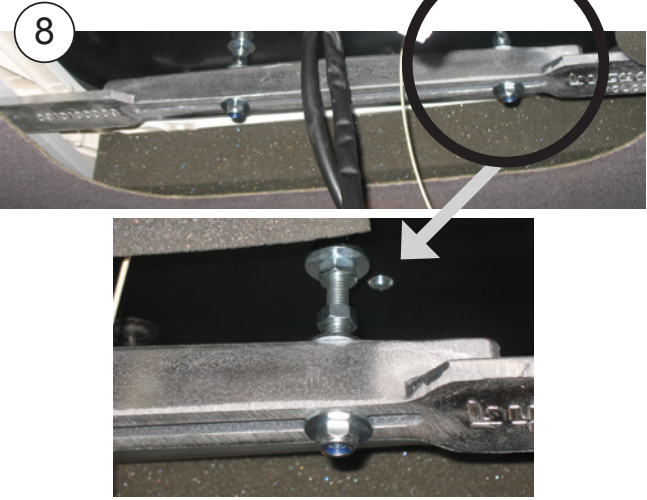

9 Roscar 10 mm (4) espárragos M6, donde se indica, según distancia (D) del esquema del punto 18.

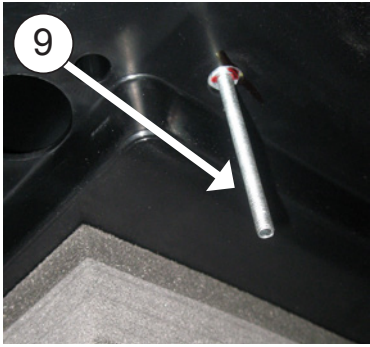
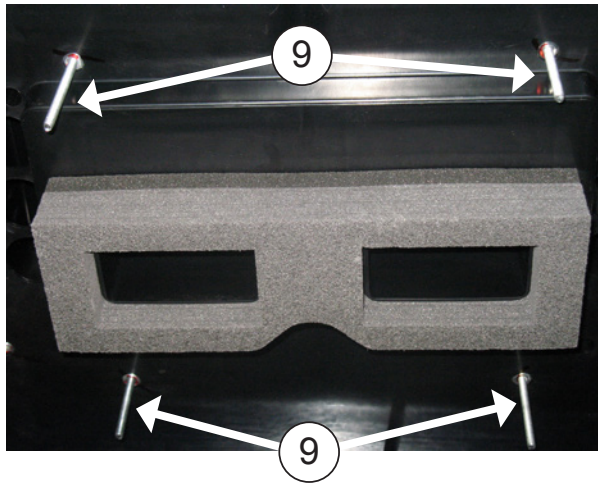

10 Colocar (1) arandela Ø6 de goma, (1) arandela plana Ø6 ala ancha y (1) tuerca M6, sobre cada uno de los espárragos de M6. A continuación apretar la tuerca hasta que la arandela de goma quede un poco oprimida.

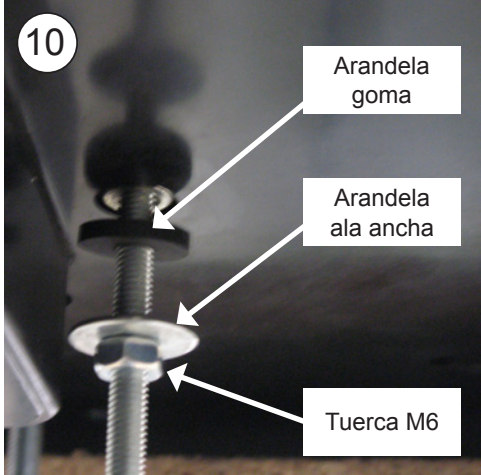

11 Colocar (1) tuerca M6 **sin apretar** en cada espárrago.

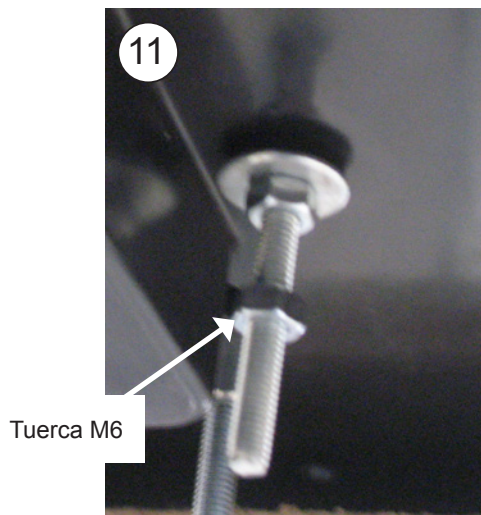

12 Entre la base y el panel interior de distribución de aire, conectar (2) cajas de dos vías de sensor antihielo (cables blancos) y sensor aire de retorno (cables negros), caja de 4 vías del soplador, (2) cables de comunicación y caja de 8 vías de cableado a conexión con control electrónico.

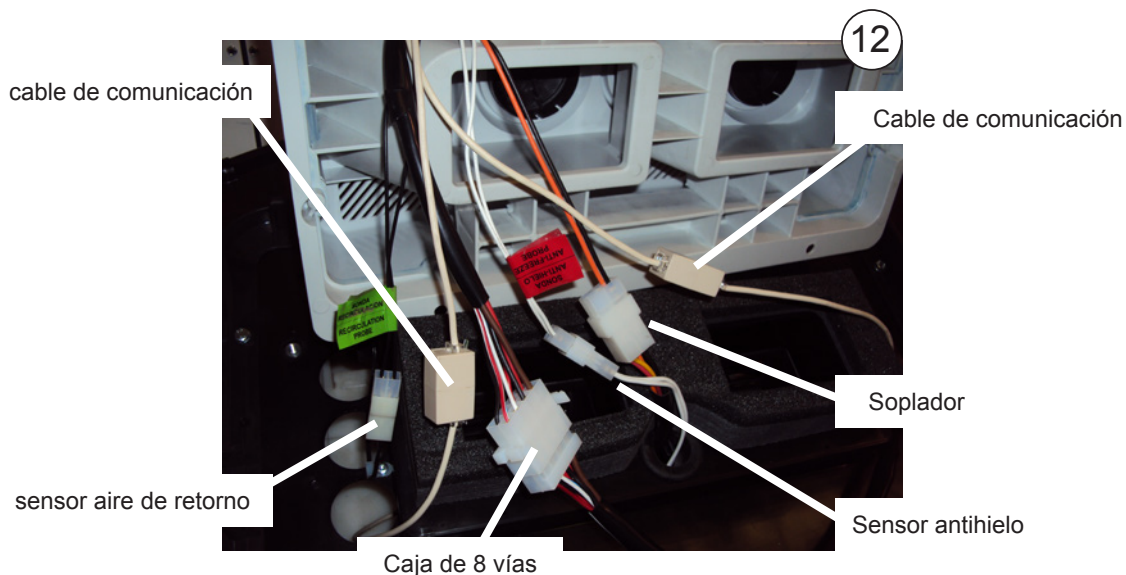

13

Colocar panel interior de distribución de aire en los espárragos anteriores con un separador hexagonal M6x25 en cada espárrago.

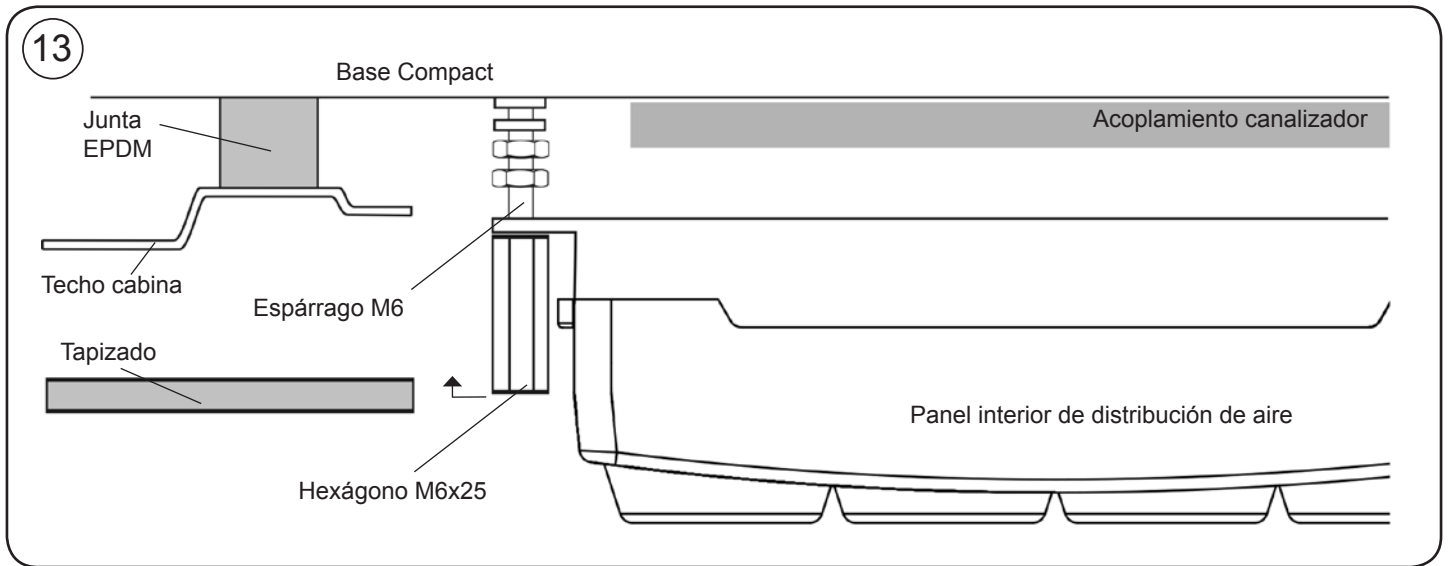

14

Presentar la consola más adecuada al modelo de vehículo y centrar el equipo en el sitio más conveniente del techo de la cabina. Una vez centrado quitar consola.

Atención: Si se elige consola (*), cortar los (4) tetones indicados a ras de la consola.

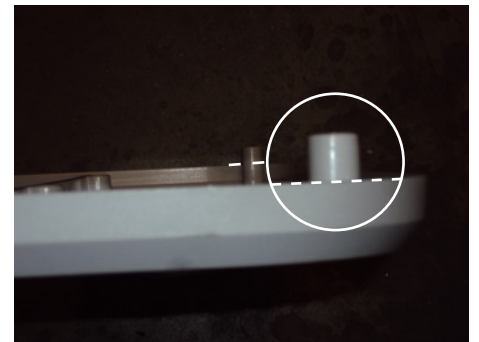
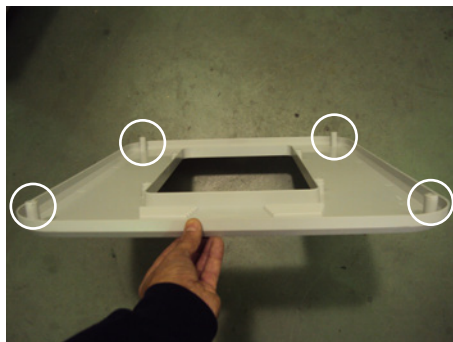
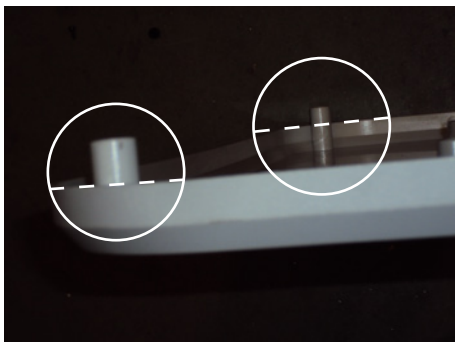
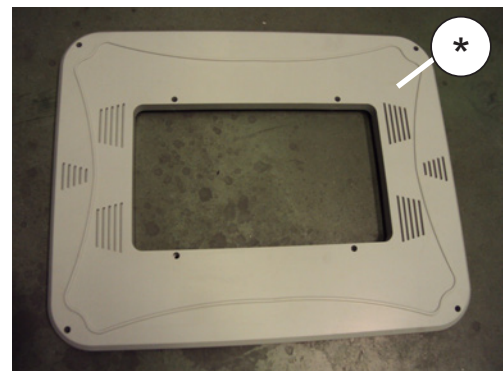

15

Fijar los soportes de sujeción apretando las tuercas A hasta el apriete de la junta de EPDM exterior (Punto 3) del equipo entre 3 y 6mm.

Importante: Para evitar posibles filtraciones de agua al interior de la cabina se debe asegurar el apriete de la junta EPDM con la base del **Compact** tal y como se indica en el **esquema**. (sig. Pagina).



16

Apretar (4) tuercas M8 (B) a la base y (4) las (C) al soporte.

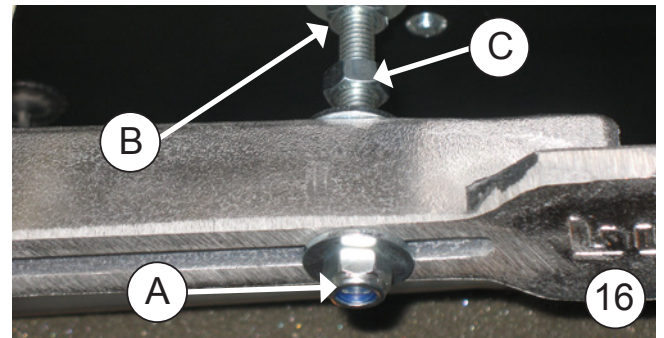
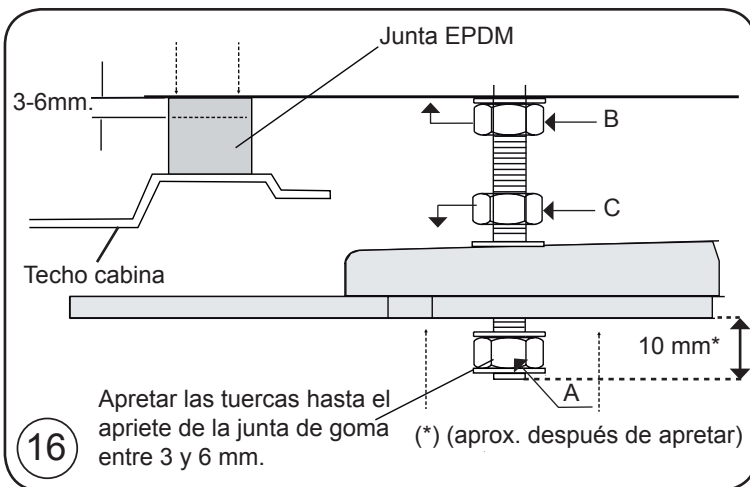

17

Apretar hexagonos hasta que los canalizadores ajusten entre sí.

18

Apretar tuerca del punto 11 hasta hacer tope con la parte superior del panel interior de distribución de aire.

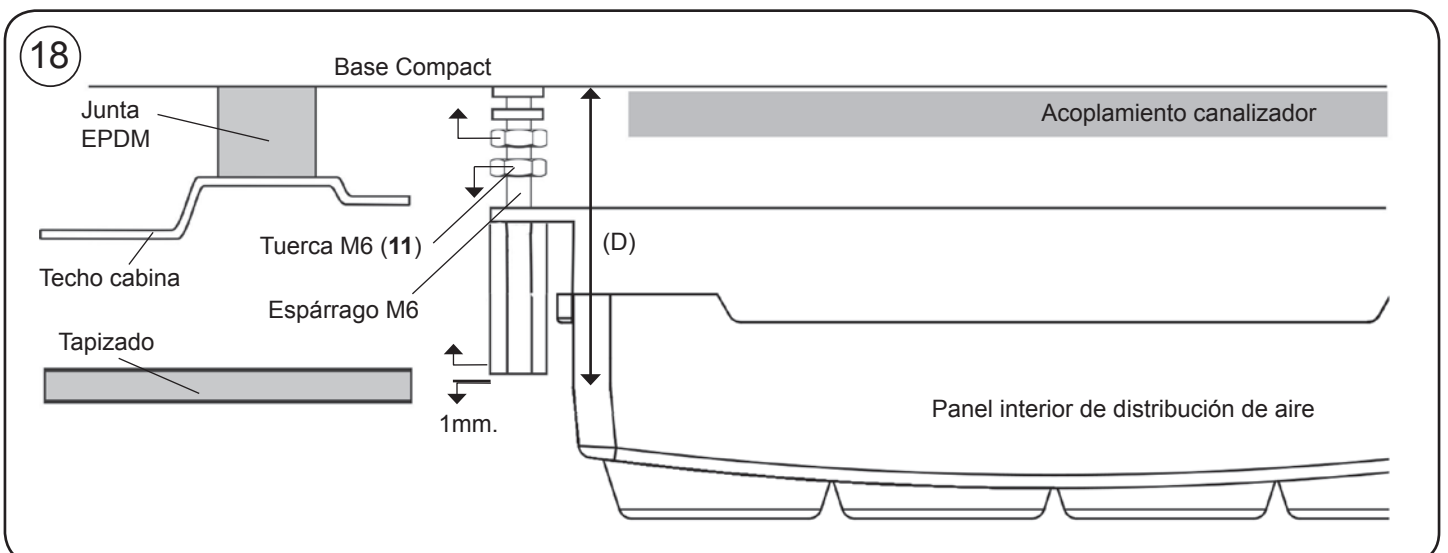

19

Colocar la consola con (4) tornillos M6/100x15 allen.

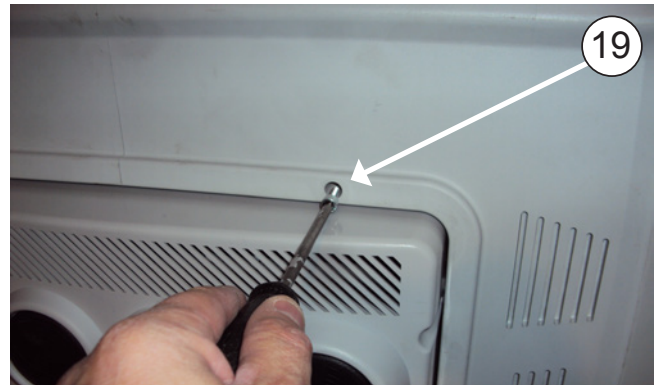

20

Cubrir los (4) tornillos M6/100x15 allen con los embellecedores redondos de M6 de plástico.

Atención: Con consola (*) cubrir también los taladros laterales (Y).

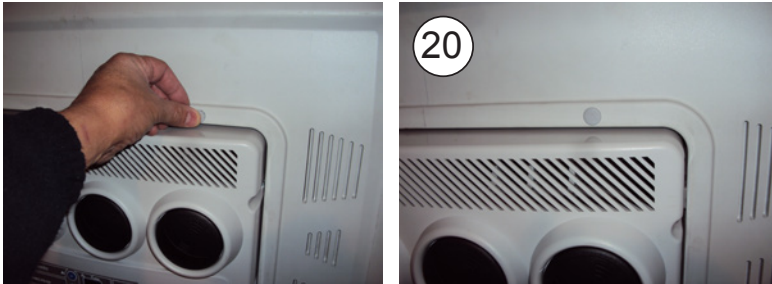

Vista explosionada hasta la fijación de los soportes

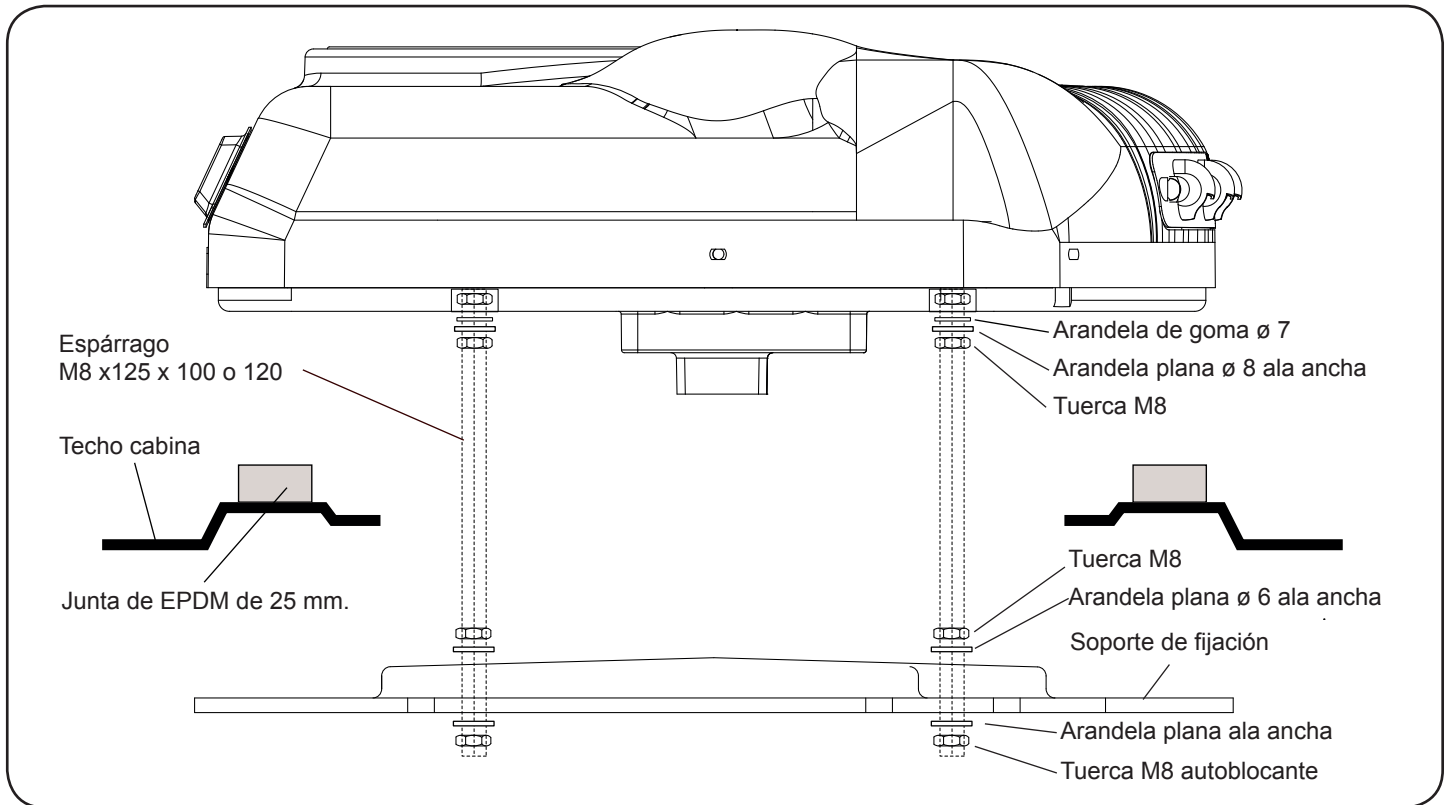

Vista explosionada hasta la fijación de las consolas

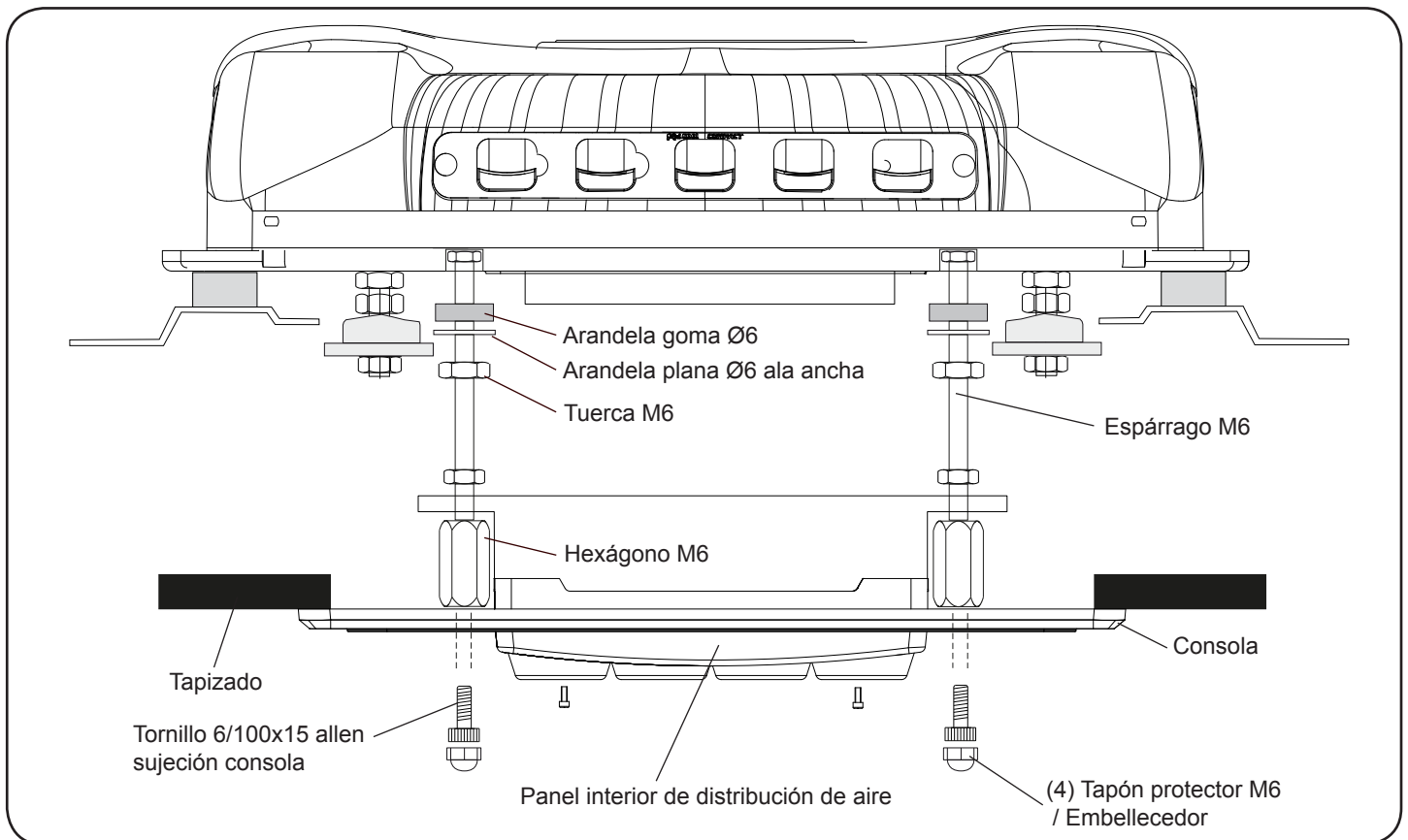

Instrucciones detalladas sobre la instalación del cableado de alimentación

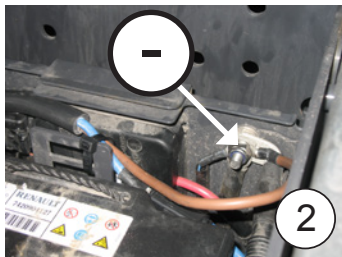
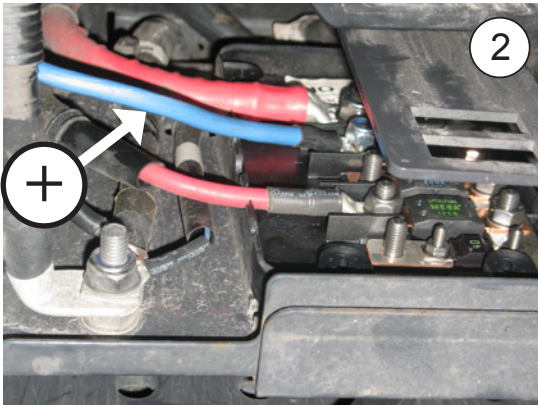

Cableado de alimentación superior

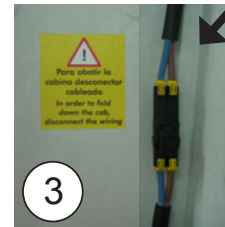

- 1- Conectar el cable de alimentación superior en la parte trasera del equipo y llevarlo por la parte posterior de la cabina pegando los soportes de plástico y fijándolo c/bridas y c/abrazaderas y tuercas a tornillos originales.
- 2- Conectar cable de alimentación inferior en Caja de fusibles el + y en el centro de masas el - como se indica, llevándolo por el paso de cableados original, sujeto con bridas, hacia la parte posterior de la cabina, para conectar con el cable de alimentación superior.

¡AL CONECTAR LOS CABLEADOS ,DEJAR LA DISTANCIA ADECUADA ,PARA EVITAR SU ROTURA POR LOS MOVIMIENTOS DE LA CABINA!

IMPORTANTE: Debido al complejo sistema de regulación electrónica del equipo, la toma de corriente debe realizarse directamente a puntos indicados de caja fusible.

Precaución de no invertir las polaridades al conectar la alimentación en el equipo. Si esto sucediera la placa no se encenderá, **el equipo no funcionará y se producirán daños irreparables** en los módulos de los compresores.

IMPORTANTE: Para la puesta en marcha consultar el Manual del Usuario.

- 3- Colocar adhesivos de peligro en unión de cableado y en dispositivo de elevación de cabina.

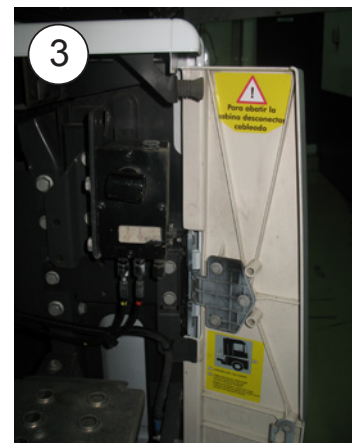

Esquema eléctrico

¡AVISO IMPORTANTE!

Precaución de no invertir las polaridades al conectar la alimentación en el equipo. Si esto sucediera la placa no se encenderá, **el equipo no funcionará y se producirán daños irreparables** en los módulos de los compresores.

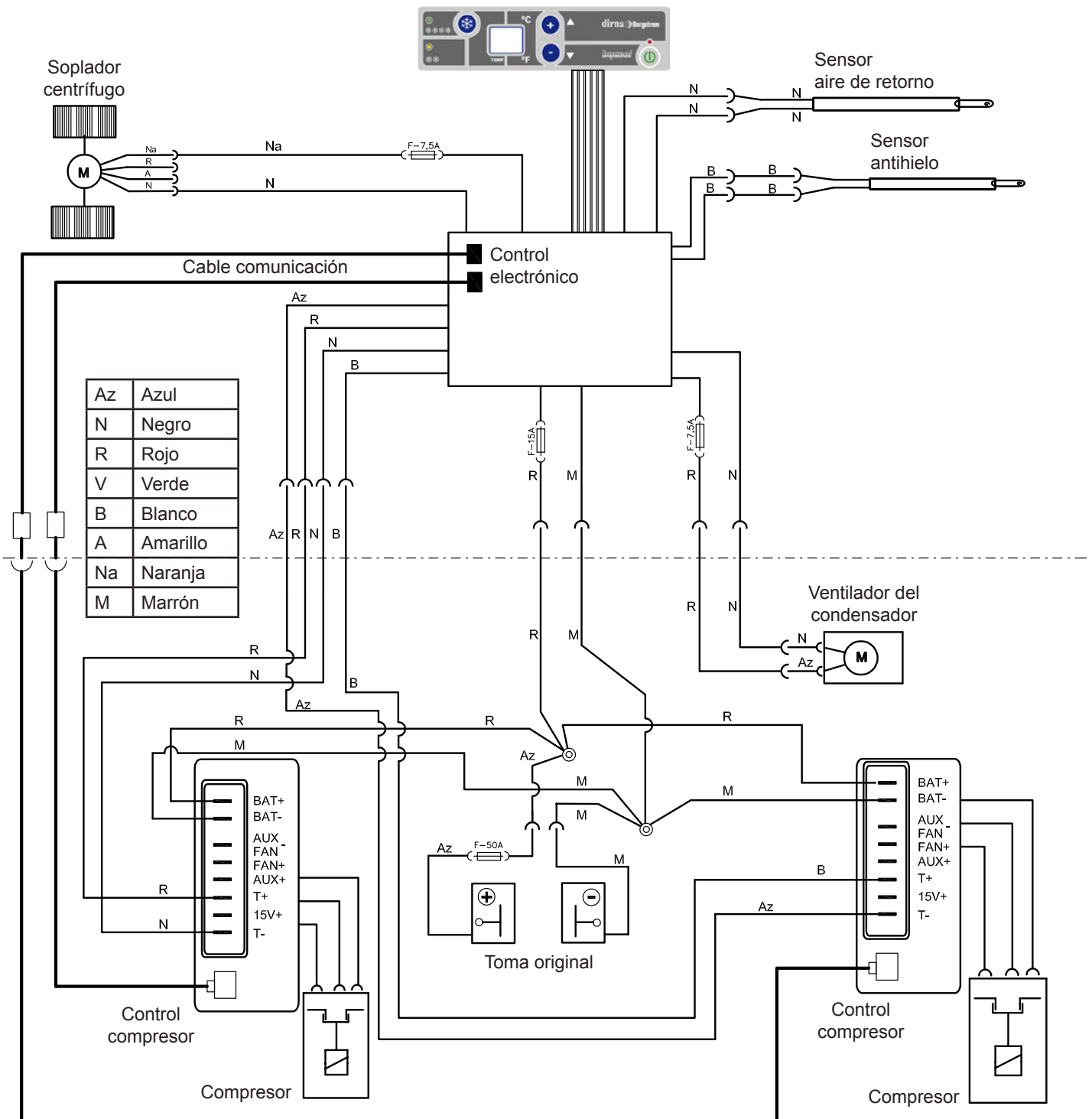

Assembly Recommendations

- Before starting assembly, please read instructions and follow them during installation process.
- Use the adequate tools for each operation.

Electricity

- Disconnect ignition key.
- Disconnect battery before starting assembly.
- Make sure electric components are securely connected, checking their correct fitting.

Warning

If the unit slants during assembly, wait for at least 60 minutes with the unit in horizontal position before starting it up.

Warning

When installing air conditioning equipment on roof, the upper cabin part must be protected with a cloth or a protective blanket to avoid possible scratches. When installing **Compact** on roof, take into account that, normally, cabins equipped with a hatch have a strong enough structure to hold equipment weight. However, if it is not the case and it is necessary to carry out a cut in the roof or, although it has a hatch, the material is not resistant enough (*if roof is made of fibre, plastic, etc...*), it is the installer who will have to decide, under his responsibility, if it is necessary to reinforce the roof to avoid possible deformations, breaks, water entries, etc., habitating the means required to stop it from occurring.



Tools

- Torx wrenches set
- Allen wrenches set
- Open-jawed spanner 10, 13, 14
- Scissors
- Flexo-meter







Documentation included

Mounting instructions	1001443781
User's guide	1001218019
Troubleshooting	1001218025
Warranty	220AA10017

Symbology

-  Fragile
-  Beware of cuts!
-  Electrical hazard

Warnings

-  The installing personnel must have a sufficient training in vehicles air conditioning.
-  **dirna Bergstrom, s.l.** shall not be responsible for breakdowns or damages coming from an inadequate handling or installation of the equipment or from modifications and substitutions carried out without our express and written authorisation.
-  **Equipment pre-charged with refrigerating gas. (Do not handle refrigerating gas circuit).**
-  Please see product **warranty procedure** included in **Troubleshooting**.
-  Please see equipment **User's Guide** for its correct functioning of the remote control and control panel.
-  Once installation is finished, the following documents must be handed over to the user: **User's Guide, Warranty and Troubleshooting**.

 Mount the front air input grille before starting assembly.



1 Dismantle sun hatch, fastening elements and hand over to client.



2 Remove residual glue substance of the roof upper surface before glueing EPDM gasket.

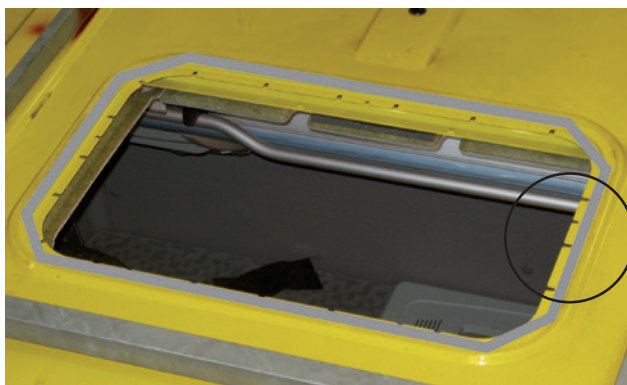

3 Glue EPDM gasket around hatch hole (see detail for cutting end join edges).





HOW TO CUT EPDM GASKET TO AVOID WATER FILTRATION INTO THE CABIN

- A- Glue gasket, keeping 100 mm of protection paper at each side.
- B- Remove the two pieces of paper.
- C- Glue by pressing both ends.

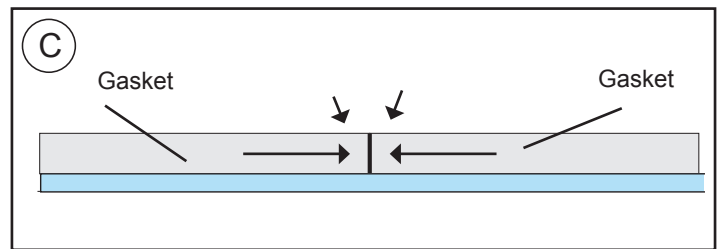
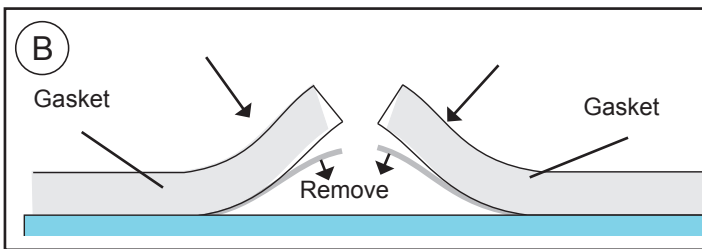
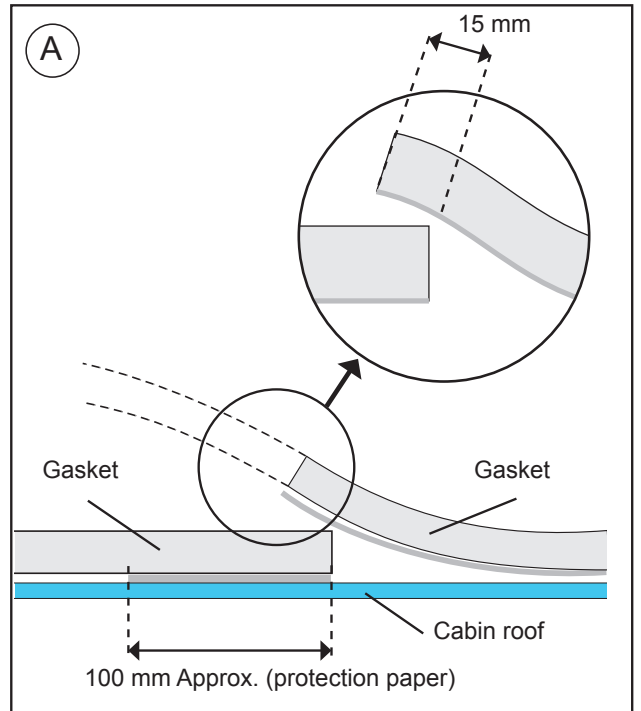

4

OUTSIDE CABIN:

Position Compact in sun hatch hole.

Caution! When positioning the unit above the hatch gap, check that the wastewater run-offs are not blocked by the EPDM seal.

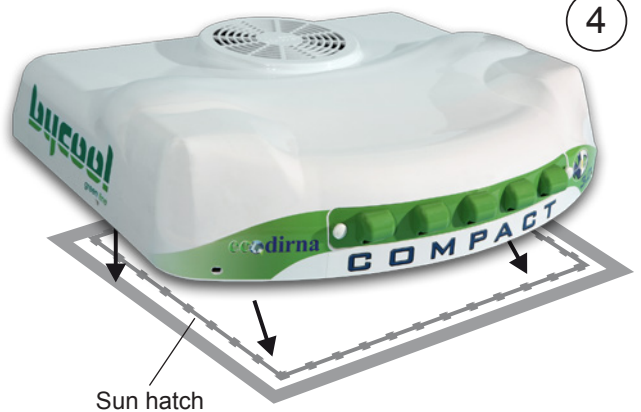

5

Position the foam rubber, ensuring the softest part is placed on the base of the unit.

Caution: Depending on the cabin, it may be necessary to use the (2) supplied ducts in order for the distribution panel to be completely adjusted.



6 **INSIDE CABIN:**
Screw about 5 mm (4) 8/125x70,100 or 120 mm studs, the exact measure is chosen after the fastening supports have been presented and taking into account that studs must stick out of lower part about 20 mm.

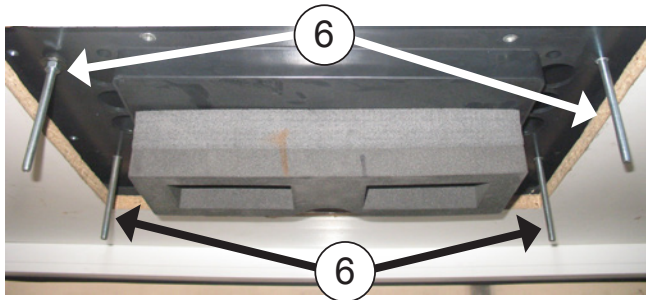
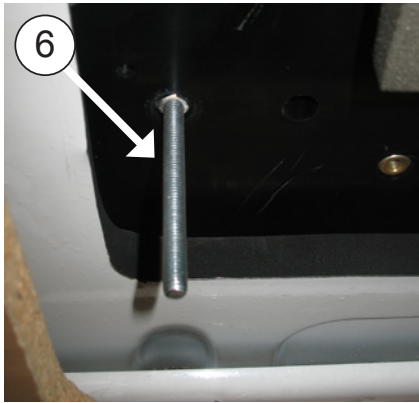
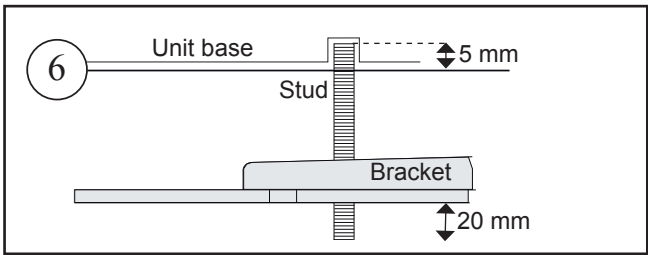

7 Colocar (1) arandela Ø 7 de goma, (1) arandela plana Ø 8 ala ancha, (2) tuerca M8 y (1) arandela plana Ø 8 ala ancha , en cada uno de los espárragos anteriores; siguiendo dicho orden.

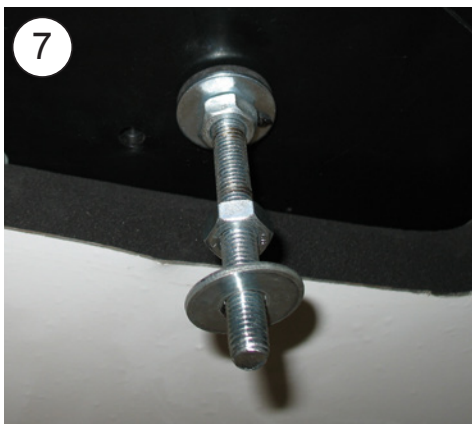

8 Place (2) fastening supports, with (1) washer and (1) M8 self-blocking nut, **without tightening**.

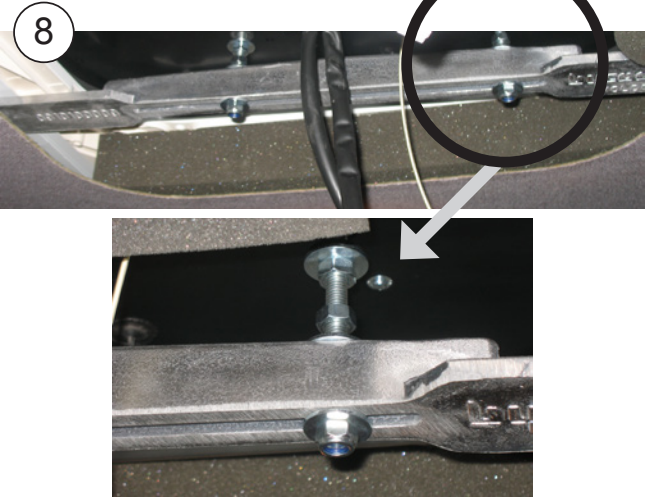

9 Screw 10 mm deep (4) M6 studs, where indicated distance (D) in figure point 18.

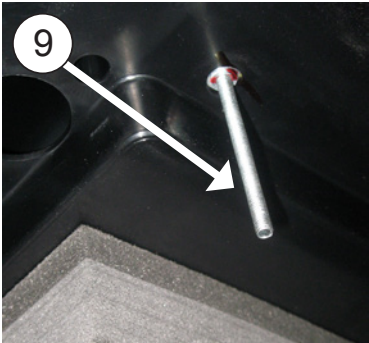
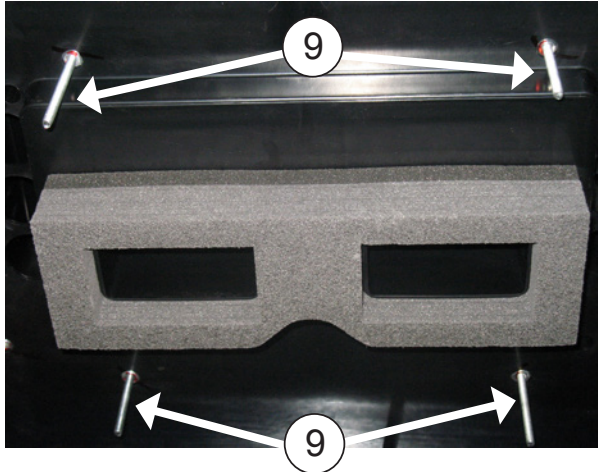

10 To place (1) rubber washer diameter 6 (1), plane washer diameter 6 wide wing and (1) nut M6, over each of the spigots of M6. After, to tight the nut til the rubber washer remain a little tight.

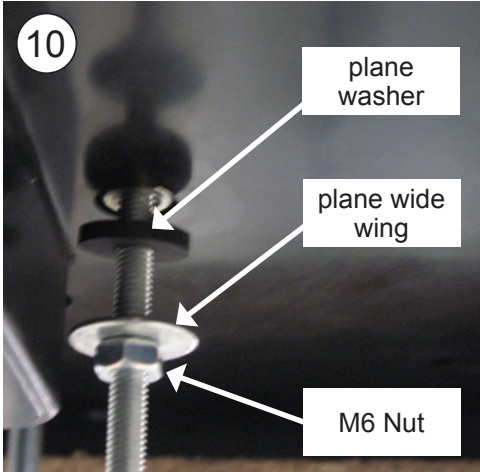

11 Place (2) fastening supports, with (1) washer and (1) M6 nut, **without tightening**.

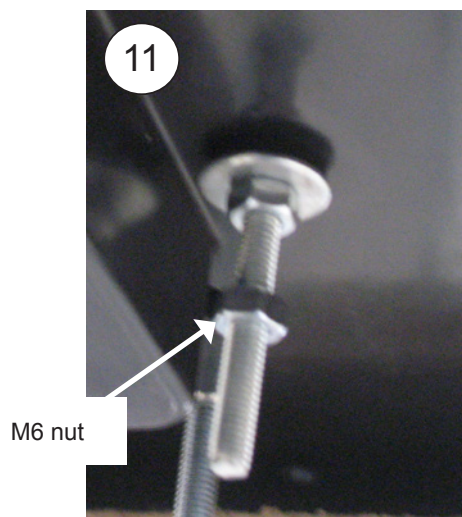

12 Between the base and the interior air distribution panel, connect (2) two-way boxes of the anti-freeze sensor (white cables) and the return air sensor (black cables), 4-way box of the blower, (2) communication cables and 8-way box of the electronic control connection cables.

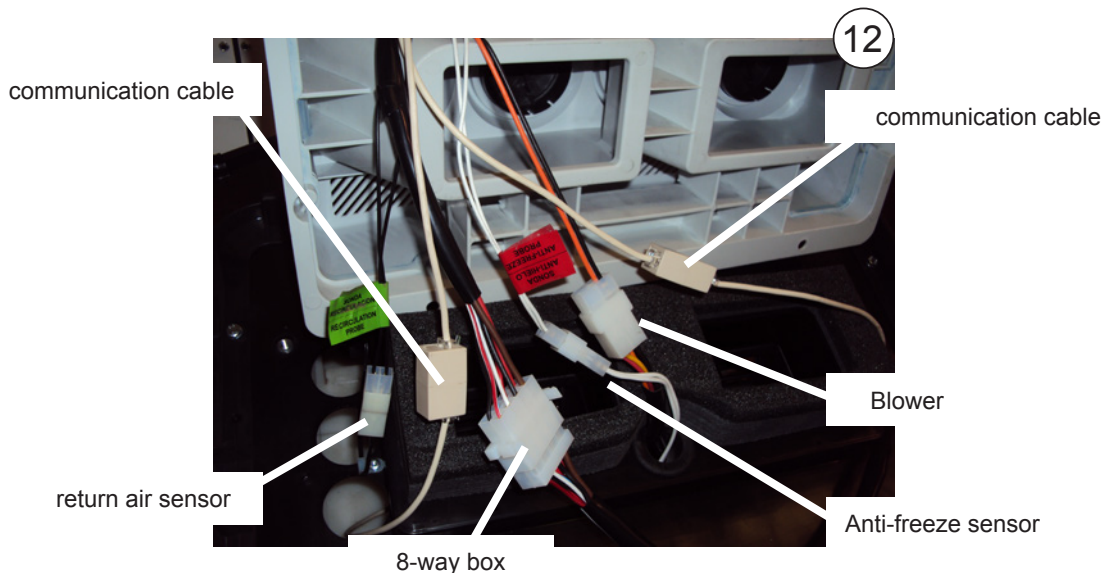

13 Position the interior air distribution panel on the front studs with a hexagonal separator of M6x25 on each stud.

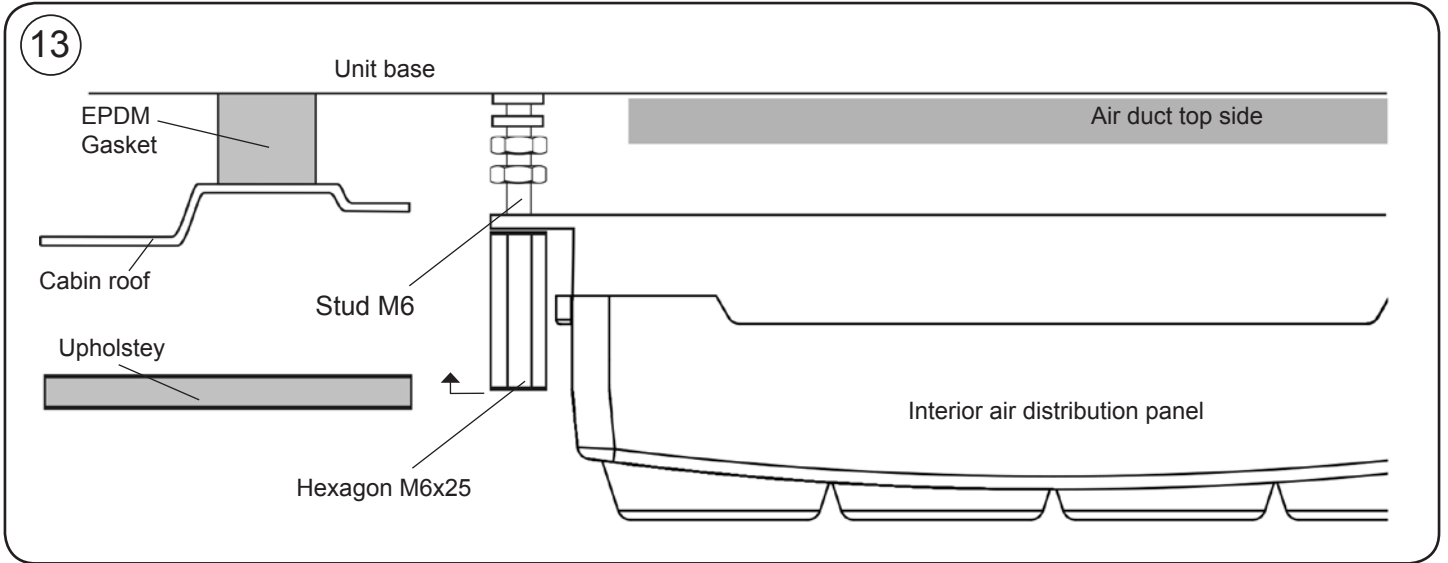

14 Position the most suitable console for the vehicle model and align the unit in the most appropriate part of the cabin roof. Once aligned, remove the console.

Caution: When choosing the console (*), cut the (4) indicated nubs so they are flush with the console.

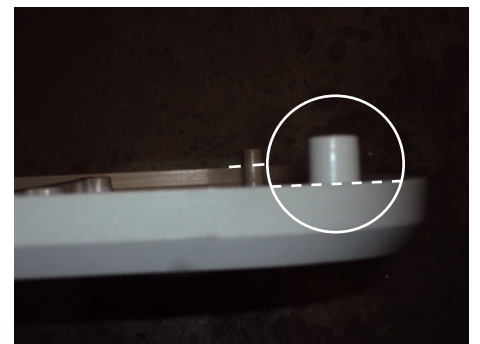
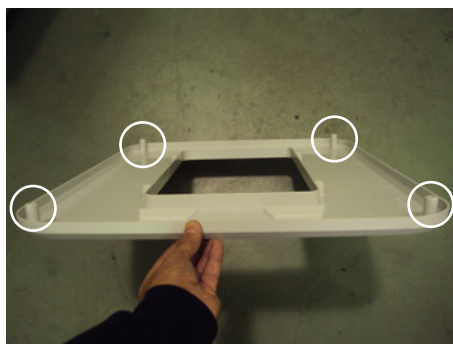
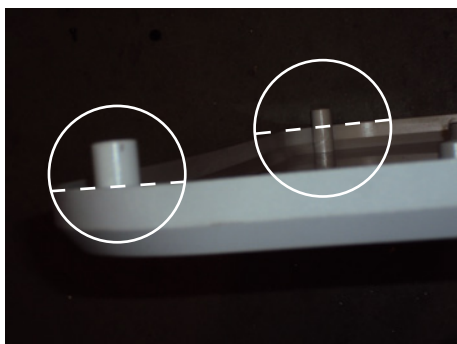
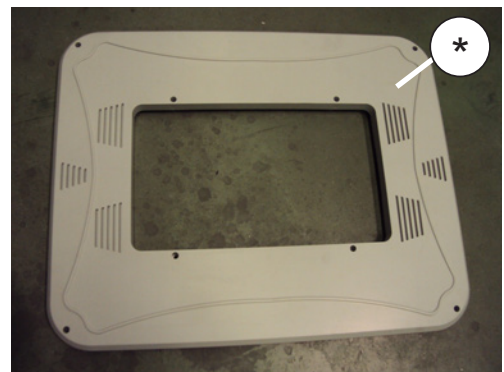

15 Fasten supports tightening nuts until outside EPDM joint (Point 3) of equipment is compressed, between 3 and 6 mm.

Important: To avoid water from filtering inside cabin, check EPDM joint tightening with Compact base, as indicated on diagram. next page.

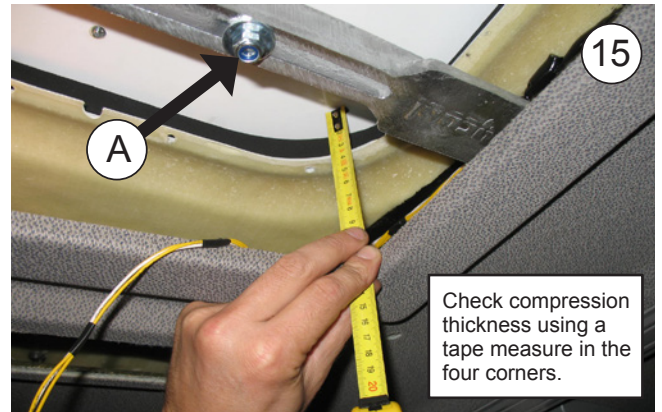

16 Tighten (4) M8 nuts to Unit base and (4) to support.

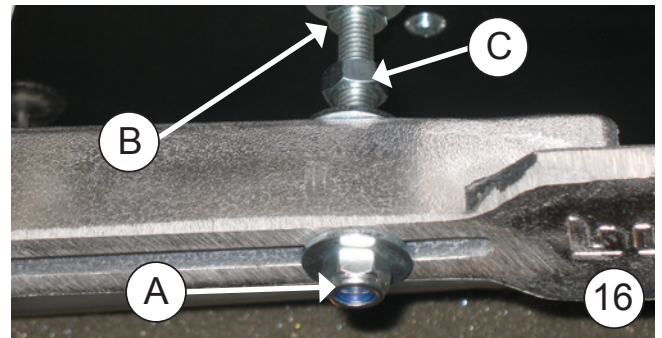
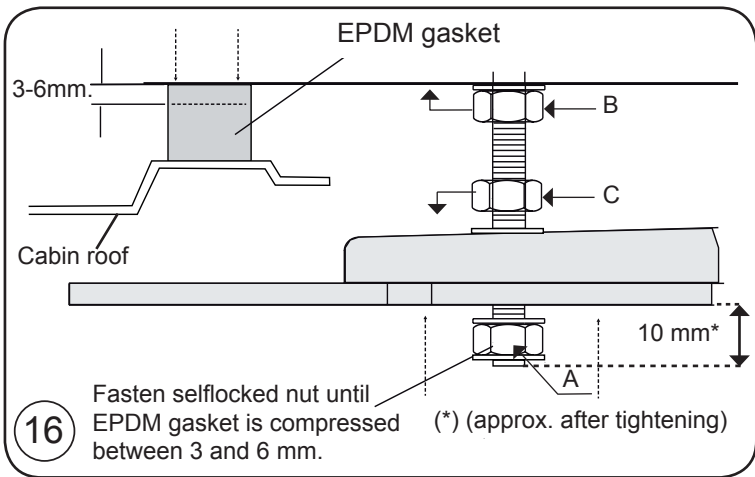

17 Tighten the Hexagon pieces until the channelling equipment fits together correctly.

18 Tighten the nut in point 11 until it comes up against the top part of the interior air distribution panel.

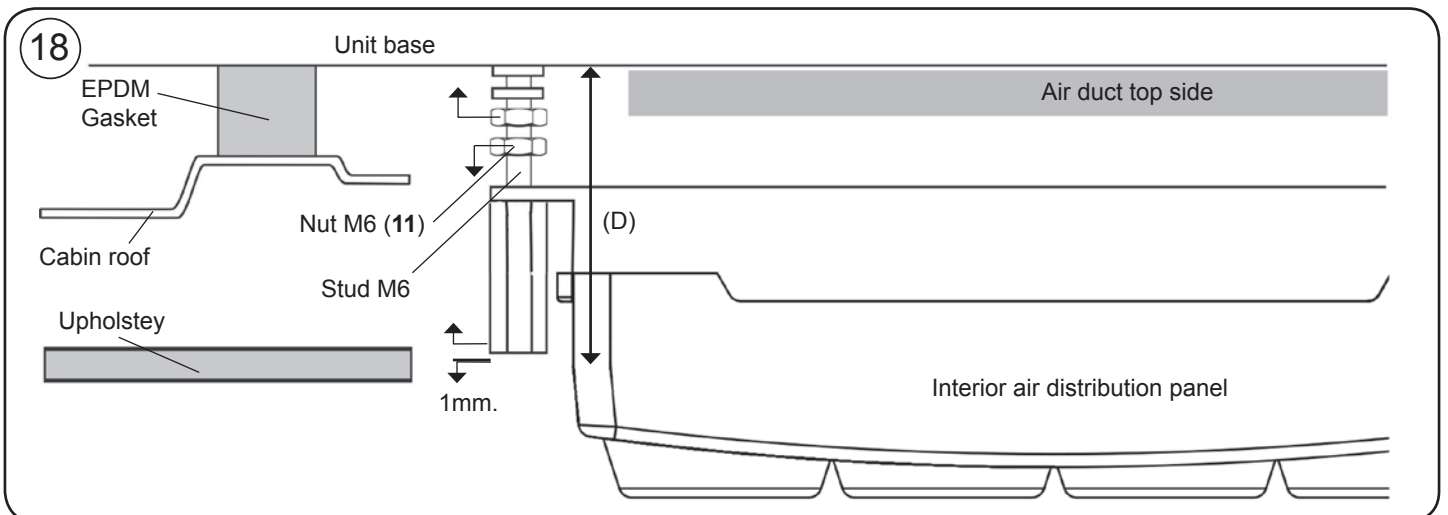

19

Place console using (4) M6/100x15 allen head screws bolts.

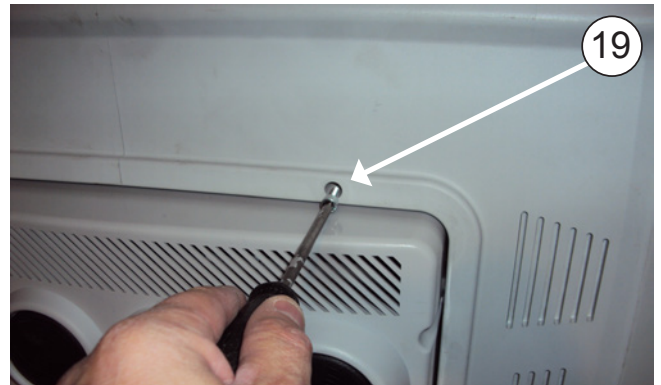

20

Cover the (4) M6/100x15 Allen screws with the M6 round plastic decorative pieces.

Caution: With the console (*) also cover the side boreholes (Y).

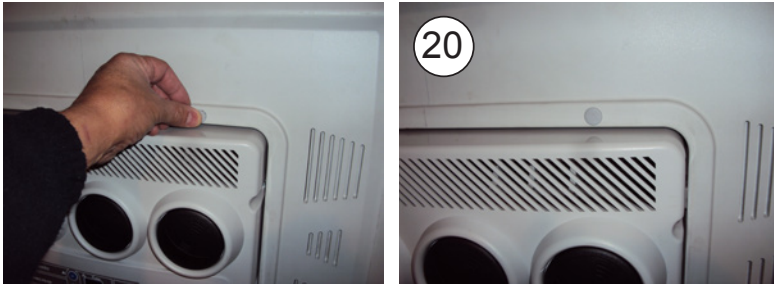

Exploded side view to supports fastening

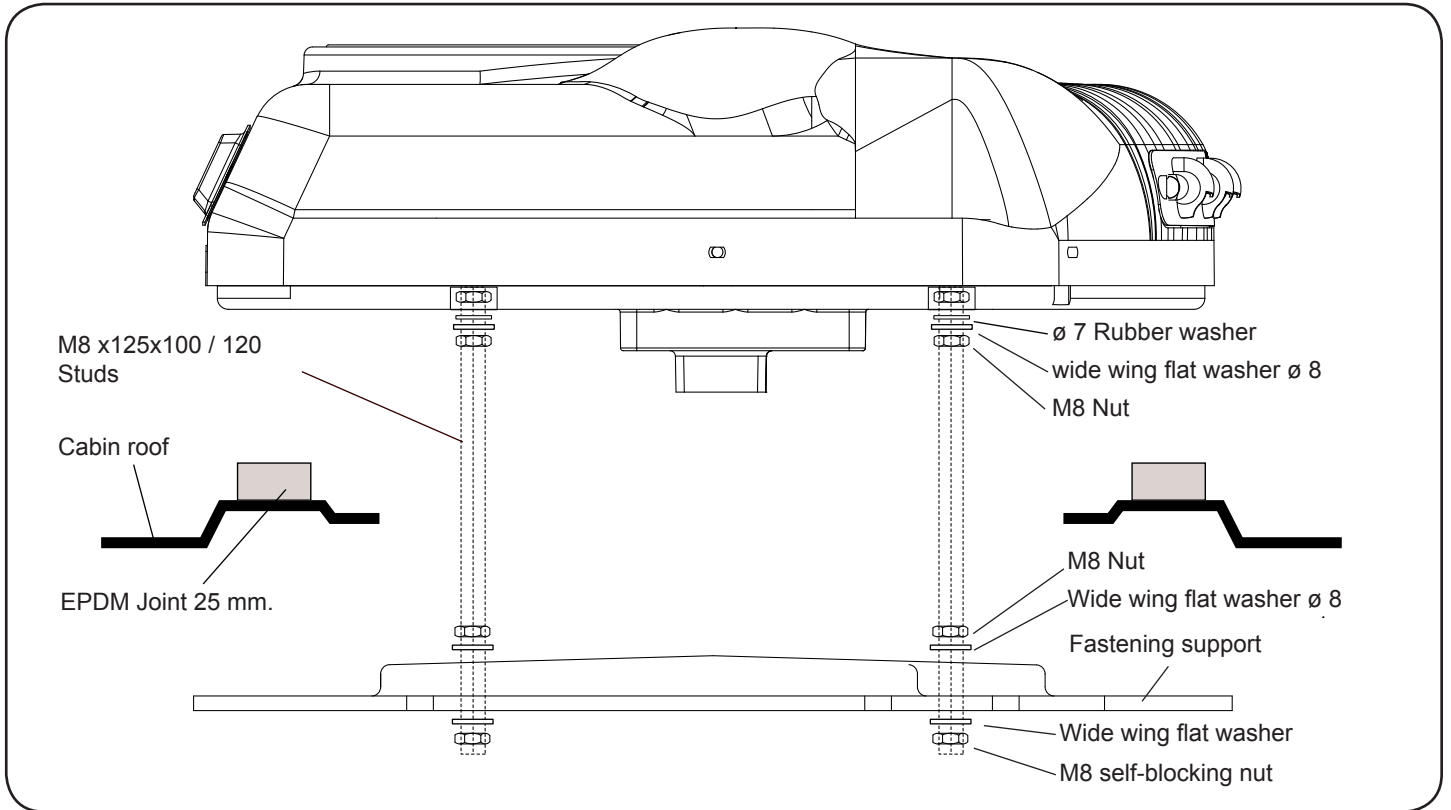

Exploded rear view to consoles fastening

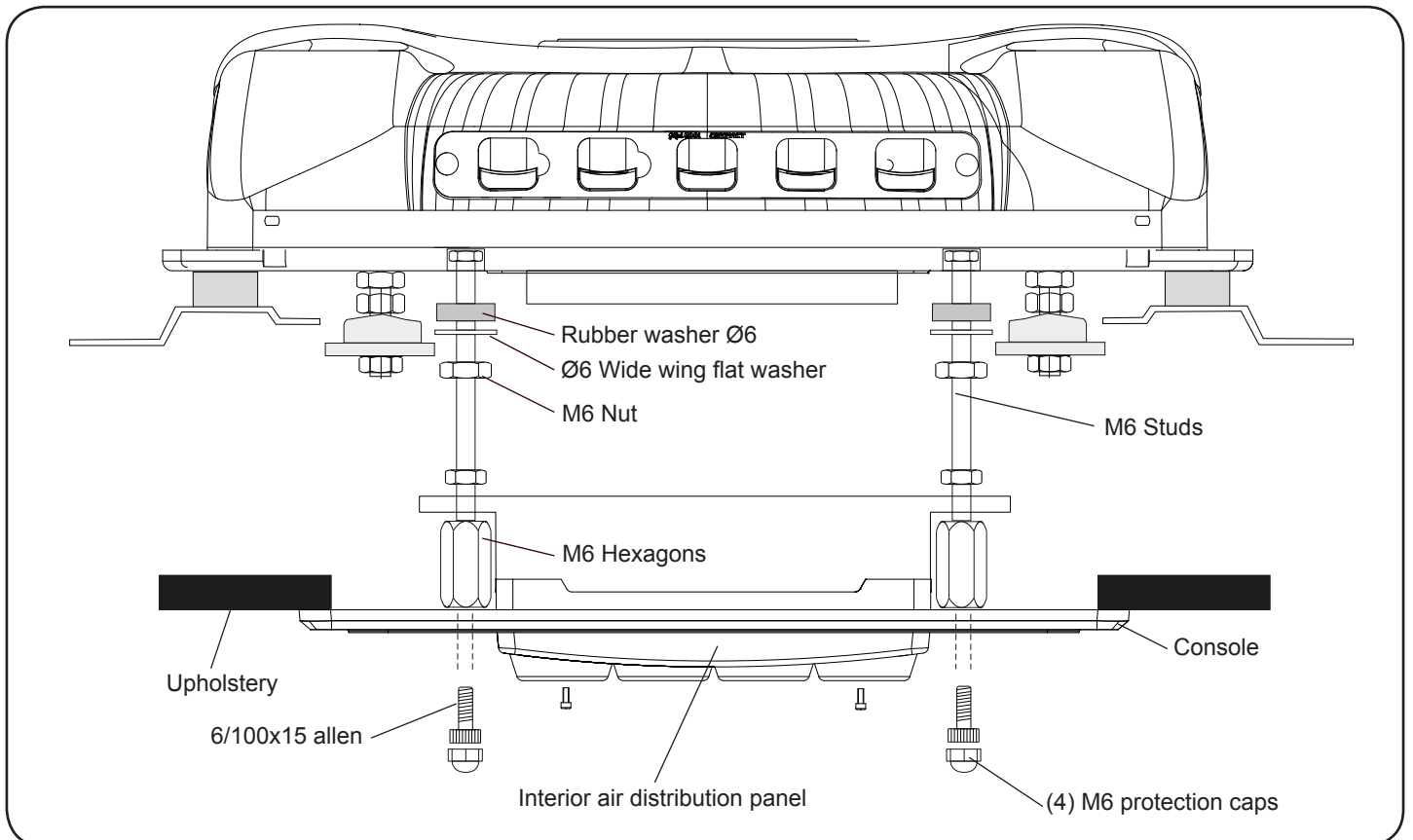

Detailed instructions on power wiring assembly

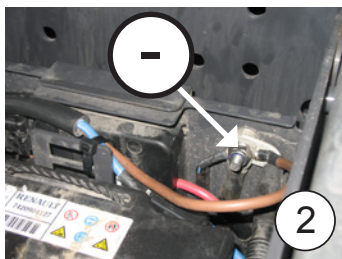
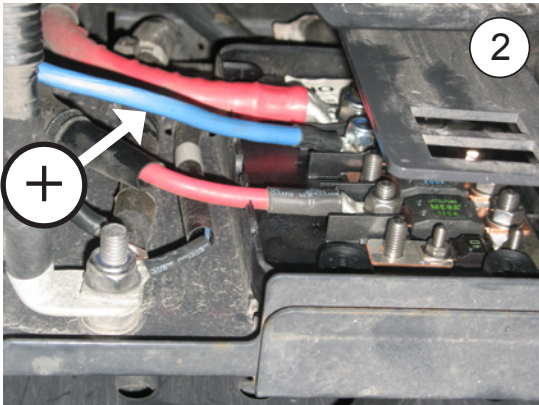

- 1- Connect the upper power supply cable to the back of equipment and lead it through the back of the cab whilst sticking down the plastic clips and securing it with flanges.
- 2- Connect the lower power supply cable to the Box of fuses + and in the center of masses- , As it is indicated, by leading it through the original cable route, secured with flanges, to the back of the cab, to connect it with the upper power supply cable.

WHEN CONNECTING THE CABLES LEAVE A SUFFICIENT DISTANCE TO PREVENT THEM BREAKING DUE TO MOVEMENTS OF THE CAB!

IMPORTANT: Due to the unit's complex electronic regulation system, the power connection must be made directly to the indicated points of the fuse box.

Take care not to invert polarities when connecting the unit to the power supply. If this were to happen, the unit will not work and irreparable damage will be caused to the compressor modules.

IMPORTANT: For start up please see the User's Manual.

- 3- Place danger stickers on the cable join and on the cab elevation device.

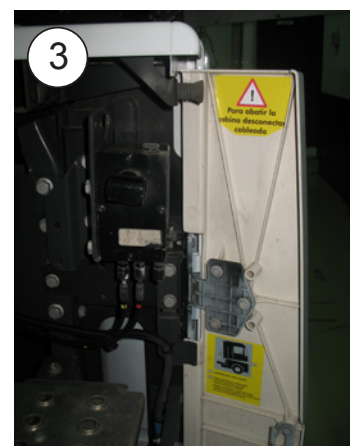

Electric wiring

IMPORTANT WARNING!

Take care not to invert polarities when connecting the unit to the power supply. If this were to happen, the unit will not work and irreparable damage will be caused to the compressor modules.

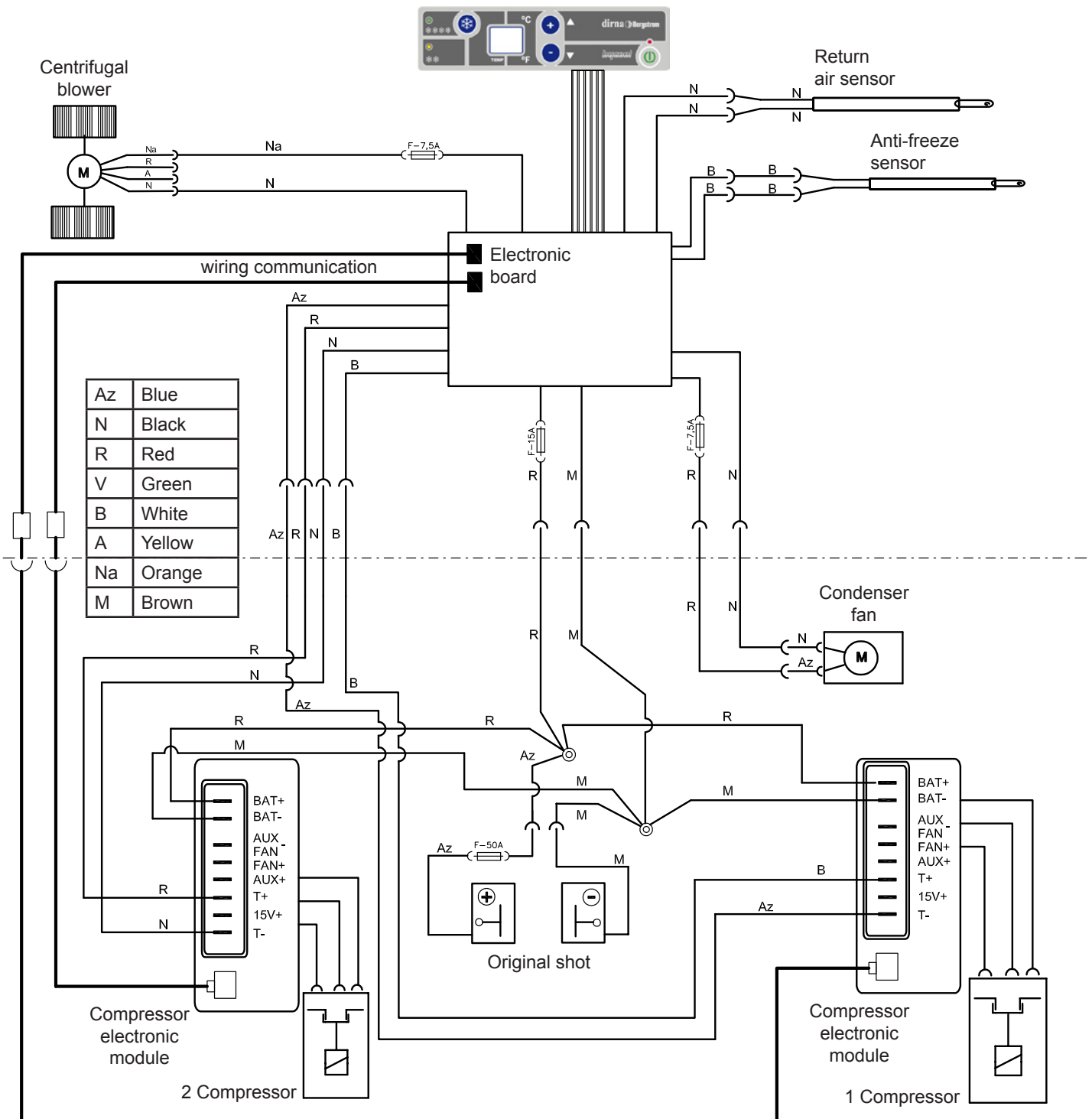

Recommandations Pour Le Montage

- Avant de commencer le montage de l'appareil, prière de lire les instructions et de les suivre attentivement.
- Utiliser les outils convenant à chaque opération.

Electricity

- Déconnecter la clé de contact.
- Déconnecter la batterie avant de commencer le montage.
- Vérifier le câblage des composants électriques et leur correcte installation.

Attention

Si pendant le montage l'équipement est incliné, il faudra attendre au moins 60 minutes avant de le mettre en marche une fois qu'il aura été remis sur sa position horizontale.

Attention

Lors de l'installation de l'appareil d'air conditionné sur le toit, il faudra protéger la partie supérieure de la cabine avec un linge ou une couverture de protection afin d'éviter les éventuelles égratignures.

Durant l'installation du **Compact**, tenir compte du fait que normalement les cabines pourvues d'écouille possède une structure suffisamment solide pour supporter le poids de l'appareil. Cependant, si ce n'est pas le cas et qu'il est nécessaire de découper le toit ou même si disposant d'écouille, la structure n'est pas suffisamment rigide (si elle était en fibre, plastique, etc.) il appartiendra à l'installateur de décider s'il faut renforcer le toit pour éviter toute déformation, rupture ou voie d'eau, etc., et prendre les mesures nécessaires à cet effet.

Outils

Jeu de clés Torx

Jeu de clés Allen

Clé fixe 10, 13, 14

Ciseaux

Mètre

Documentation included

Instructions de montage	1001443781
Guide de l'utilisateur	1001218019
Solution des problèmes	1001218025
Garantie	220AA10017

Symbologie



Fragile





Attention aux coupures !



Risque électrique

Garantie

 L'installateur devra posséder la formation pertinente en air conditionné sur véhicules.

 **dirna Bergstrom, s.l.**, ne sera pas responsable des dommages ou des bris dérivés d'une installation ou d'une manipulation incorrecte ni des modifications réalisées sans autorisation expresse par écrit.

 **Appareil pré-chargé de gaz réfrigérant. (Ne pas manipuler le circuit de gaz réfrigérant).**

 Voir **la procédure de garantie** du produit au **Diagnostic de problèmes**.

 Voir le **Guide de l'Usager** de l'appareil pour le fonctionnement correcte de la télécommande et du tableau de commande.

 Après l'installation, vous devez fournir à l'utilisateur: Manuel d'utilisation, garantie et diagnostic de pannes.

 Avant de commencer le montage, monter la grille d'entrée d'air frontale.



1 Démontez le couvercle de l'écouille, les éléments de fixations et les remettez au client.



2 Éliminer les restes d'adhésif de la surface supérieure de la cabine avant de coller le joint EPDM.

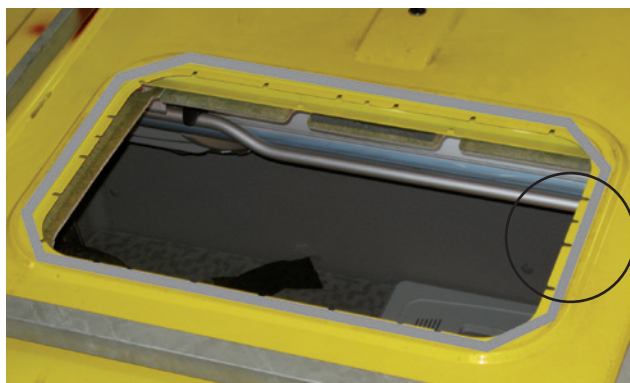

3 Coller le joint EPDM autour de l'orifice de l'écouille (voir détail pour découper les bords).



**COMMENT COUPER LE JOINT EPDM POUR EVITER LES FILTRATIONS DANS LA CABINE**

- A- Coller le joint en maintenant une protection en papier de 100 mm de chaque côté.
- B- Retirer les deux morceaux de papier.
- C- Coller en faisant pression sur les deux extrémités.

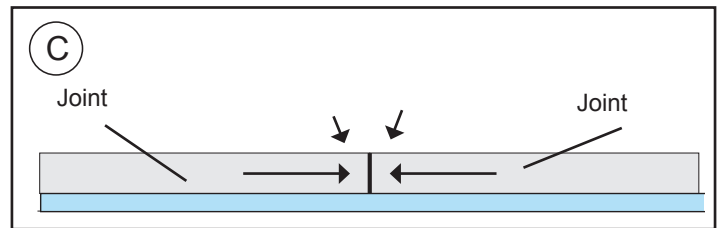
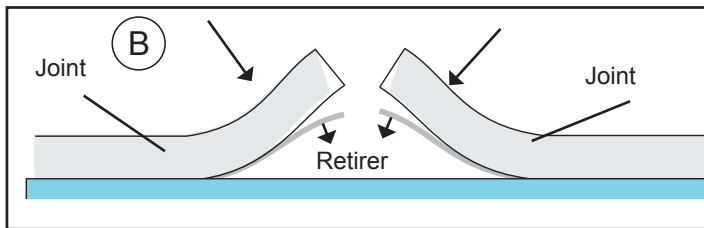
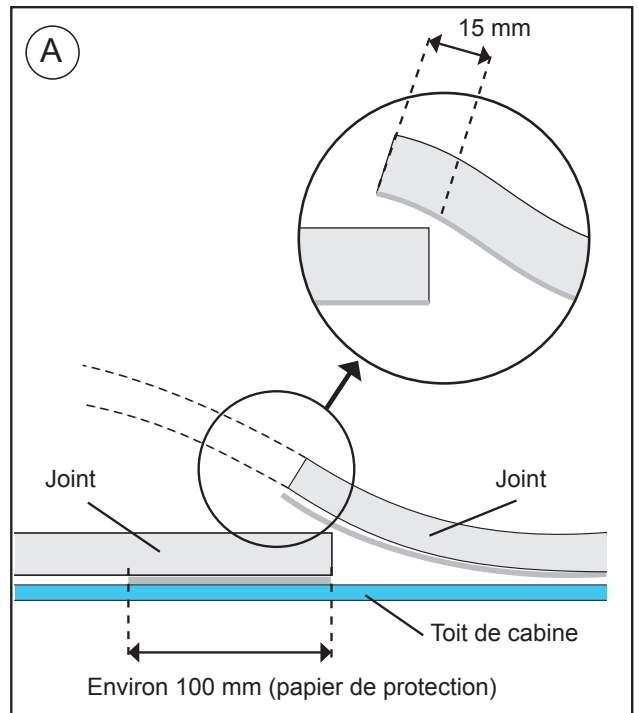
**4****EXTERIEUR CABINE:**

Positionner le Compact dans l'espace prévu.

Attention ! Avant de placer l'équipement sur le creux de l'écouille, vérifier que les sorties d'écoulement ne soient pas bouchées par le joint EPDM.

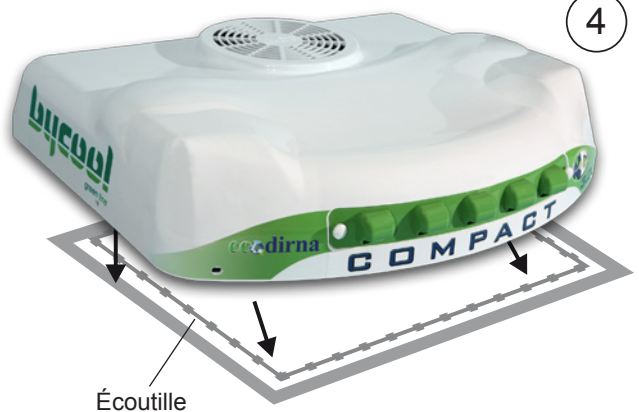
**5**

Placer le canalisateur en caoutchouc mousse en laissant la partie la plus molle sur la base de l'équipement.

Attention: en fonction de la cabine, il est possible de devoir utiliser les (2) canalisateurs fournis pour que le panneau de distribution d'air reste totalement ajusté avec ces derniers.



6 **INTERIEUR CABINE:**
 Visser 5 mm environ (4) goujons de 8/125x70, 100 ou 120 mm, en fonction de la distance plus ou moins grande de l'appareil jusqu'à ce qu'en positionnant les supports de fixation, il ne reste que 20 mm au-dessous de ces supports.

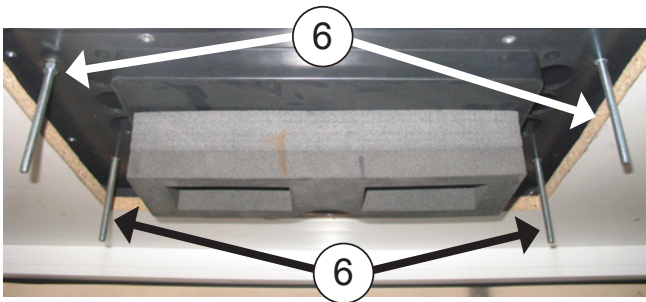
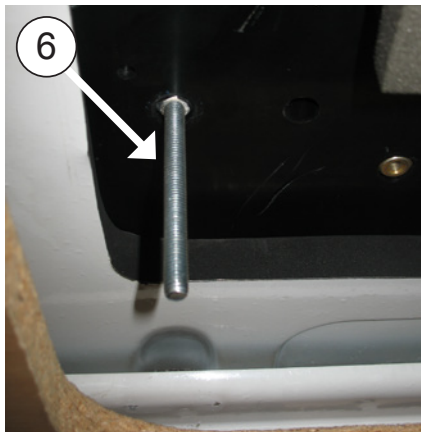
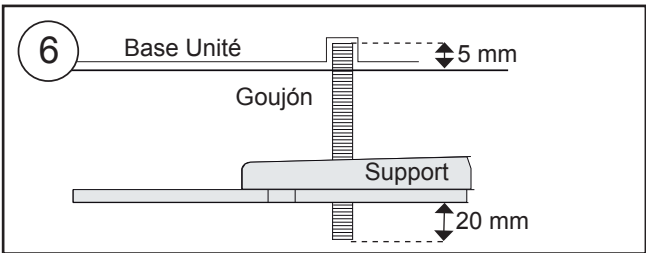

7 en suivant cet ordre :
 Rondelle a mousse, rondelle plain diamètre 8 aile large, écrou M8, plain rondelle diamètre 8 aile large.

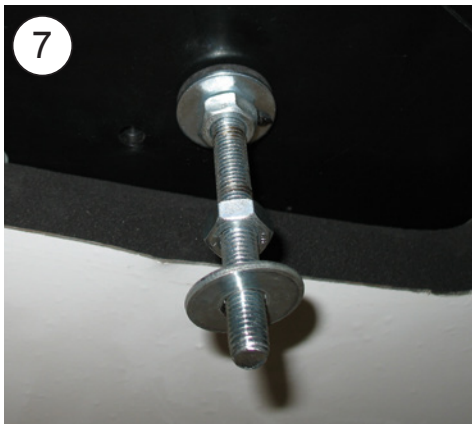

8

Placer les supports de fixation (2), avec une rondelle (1) et un écrou autobloquant (1) M8, sans serrer.

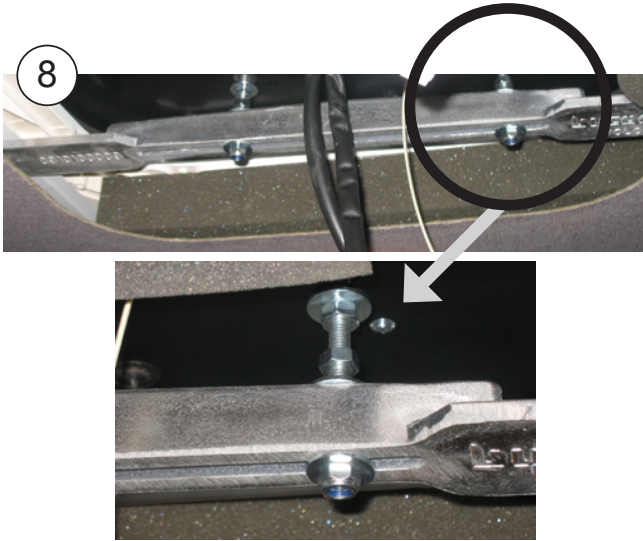

9

Visser 10 mm les goujons (4) M6 x 80, comme indiqué au (D) du schéma point 18.

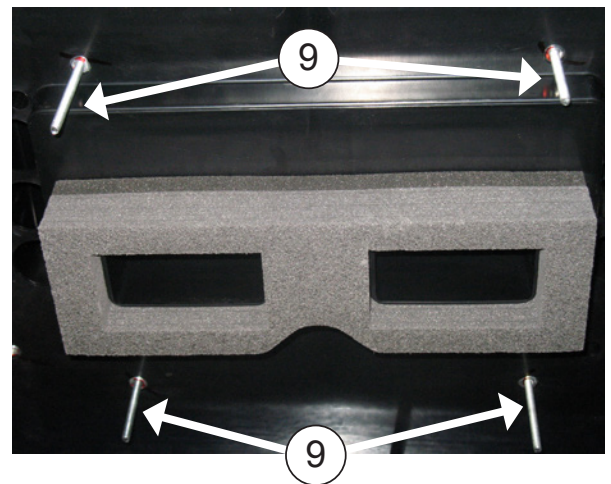

10

Placer (1) rondelle mouse diamètre 6 (1) plain rondelle diamètre 6 aile large et (1) écrou M6 sur chacun des asperges M6. En suivant serrer l'écrou jusqu'à la rondelle à mouse reste un peu pressée.

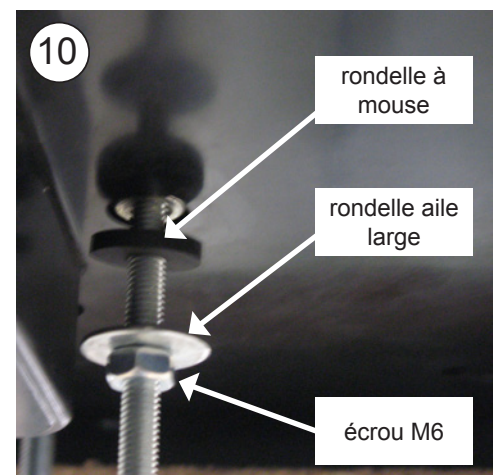

11 Placer l'écrou (1) M6 sans le serrer sur chaque goujon.

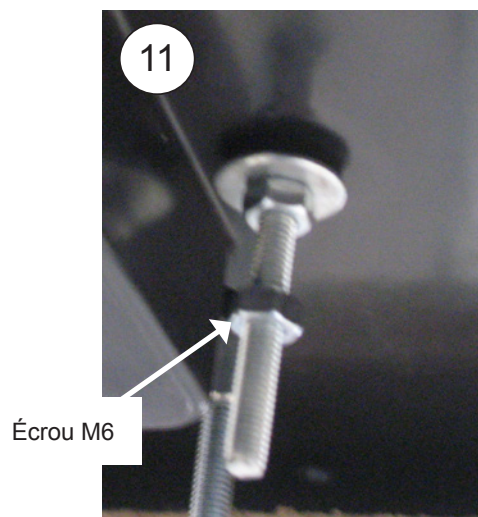

12 Entre la base et le panneau inférieur de distribution d'air, connecter (2) boîtes à deux voies de capteur antigel (câbles blancs) et capteur d'air de retour (câbles noirs), la boîte à 4 voies du souffleur, (2) câbles de communication et la boîte à 8 voies de câblage à la connexion avec contrôle électronique.

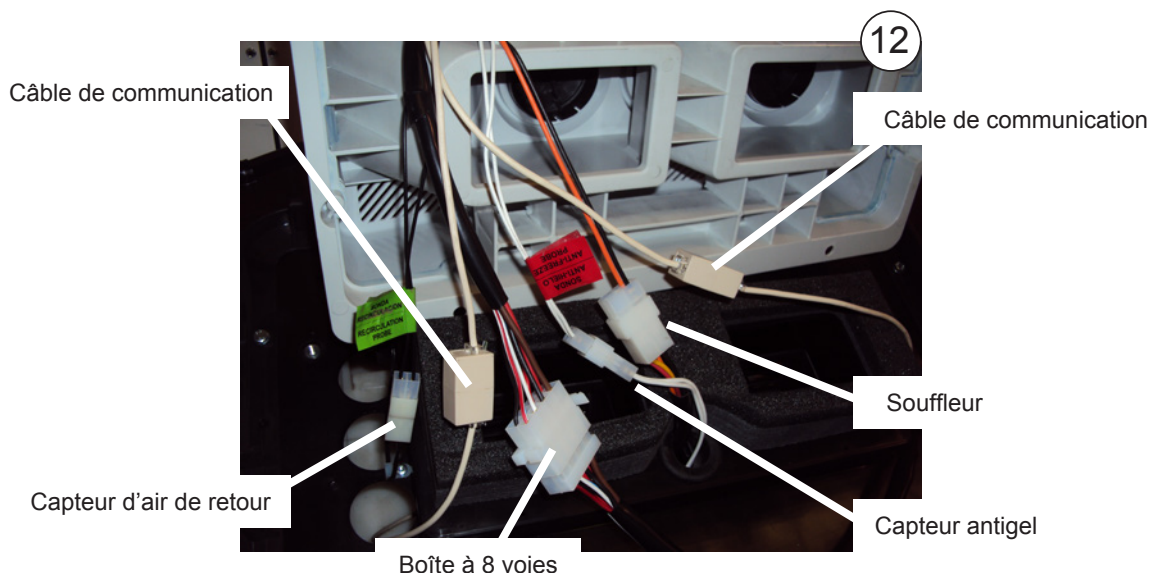

- 13** Placer le panneau intérieur de distribution d'air dans les goujons précédents avec un séparateur hexagonal M6x25 dans chaque goujon.

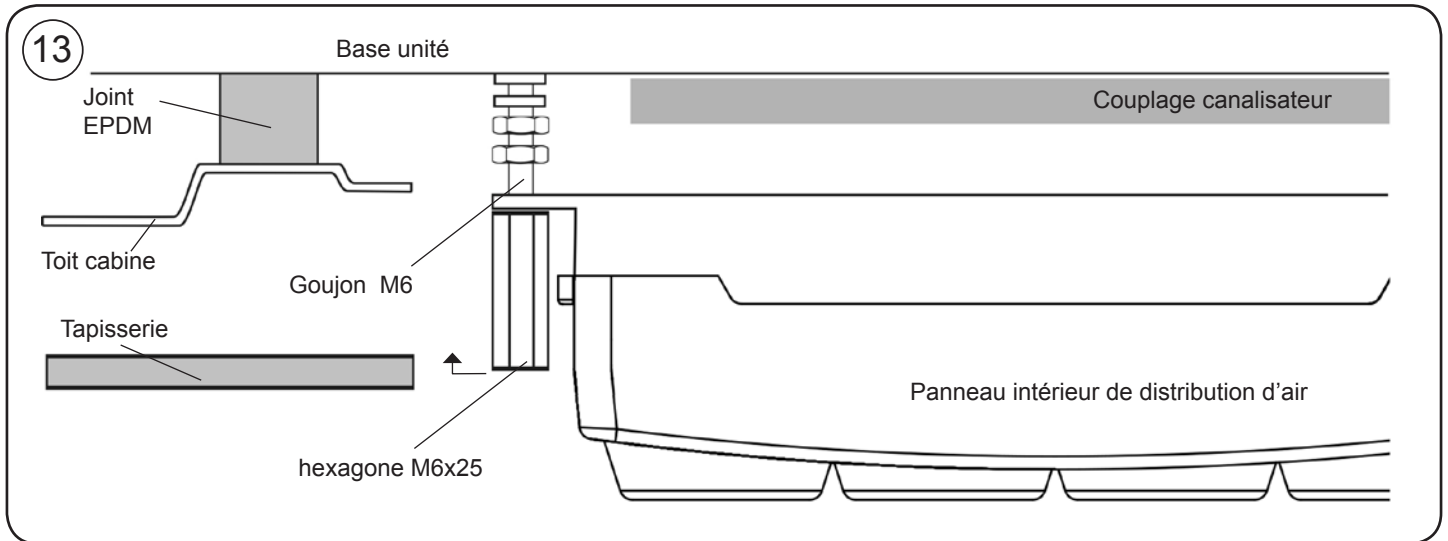

- 14** Présenter la console la plus adaptée au modèle de véhicule et centrer l'équipement sur l'emplacement le plus convenable du toit de la cabine. Une fois centré, retirer la console.

Attention: si la console (*) est choisie, couper les (4) tétons indiqués au ras de la console.

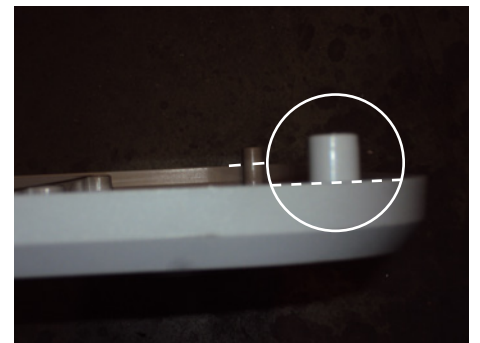
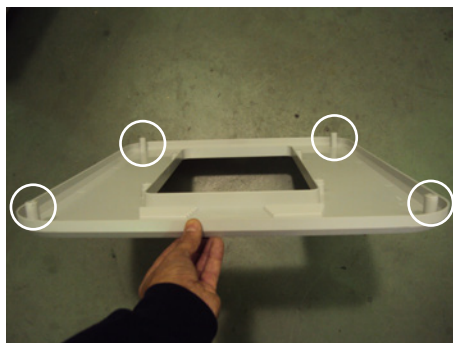
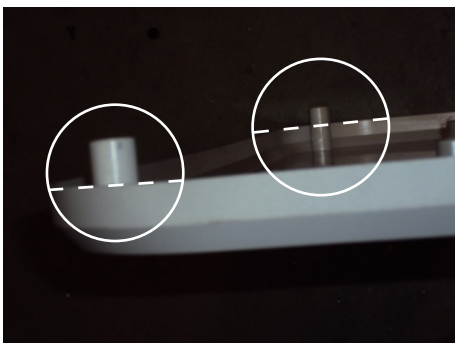
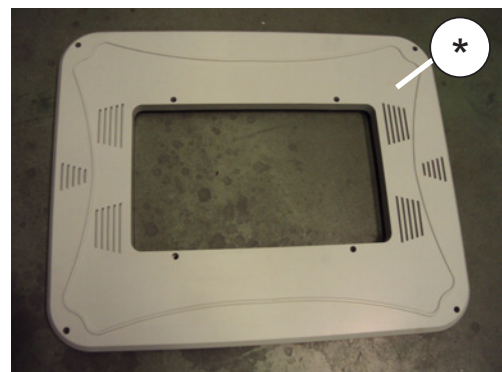

15

Fixer les supports en serrant les écrous jusqu'à serrer le joint EPDM (**Point 3**) de l'appareil entre 3 et 6 mm;

Important: Pour éviter la filtration d'eau dans la cabine, vérifier le serrage du joint EPDM à la base du Compact, comme indiqué sur le **diagramme**.



16

Serrer les écrous (4) M8 (B) afin de fixer à (4) l'unité base (C).

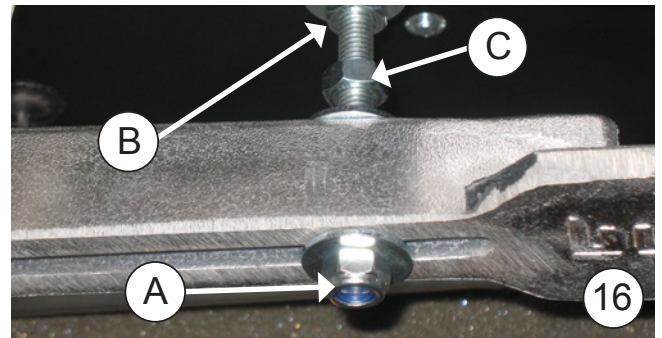
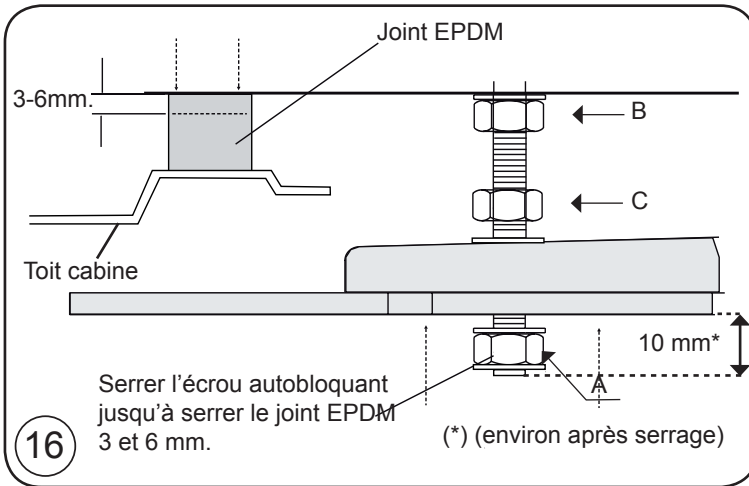

17

Serrer les Hexagones jusqu'à ce que les canalisations s'ajustent entre elles.

18

Serrer l'écrou du point 11 jusqu'à atteindre la partie supérieure du panneau intérieur de distribution d'air.

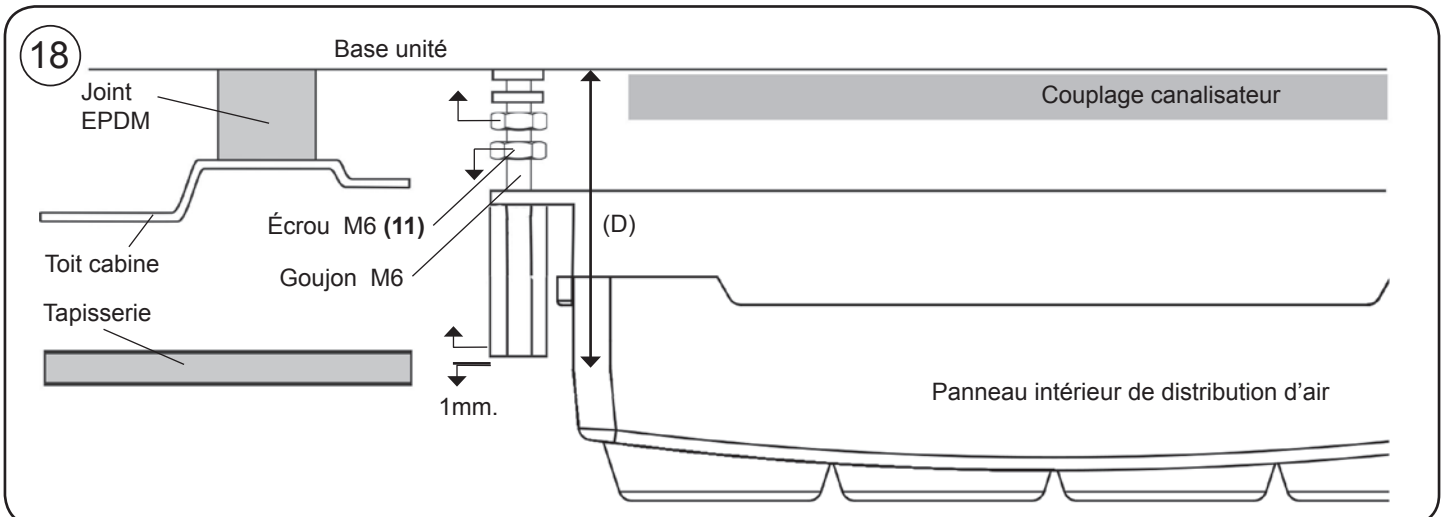

19

Placer la console à l'aide des (4) vis Allen M6/100x15.

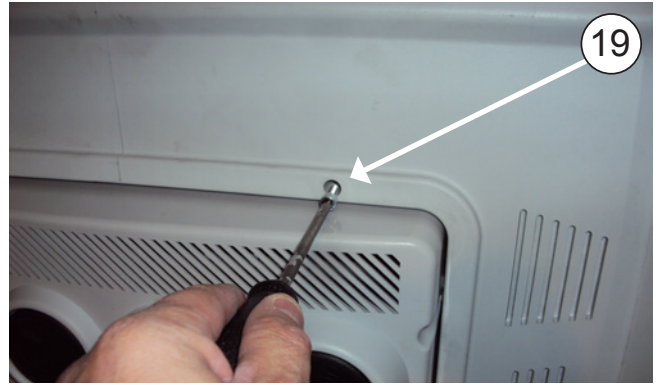

20

Couvrir les (4) vis M6/100x15 Allen avec les enjoliveurs ronds de M6 en plastique.

Attention: Avec la console (*), couvrir également les trous latéraux (Y).

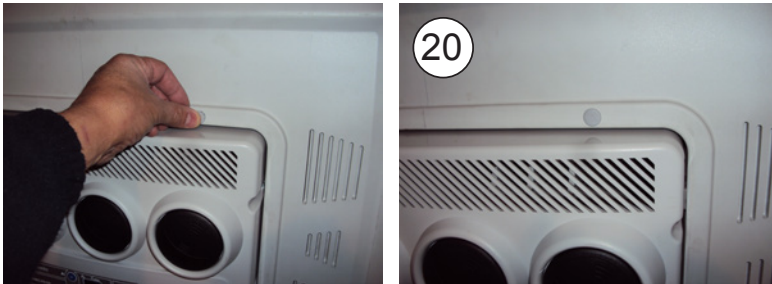

Vue explosée jusqu'à la fixation des supports de fixation

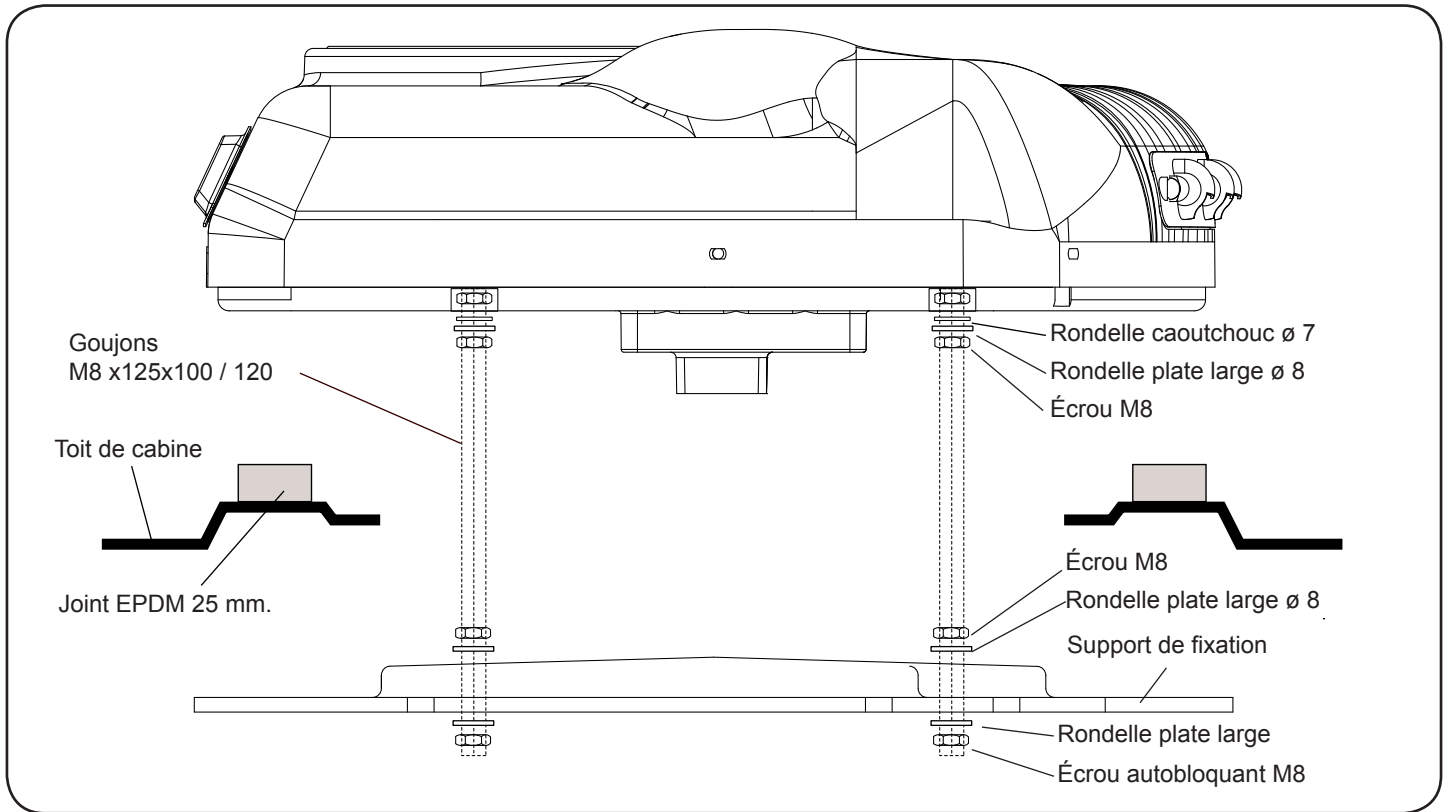

Vue explosée jusqu'à fixation des consoles

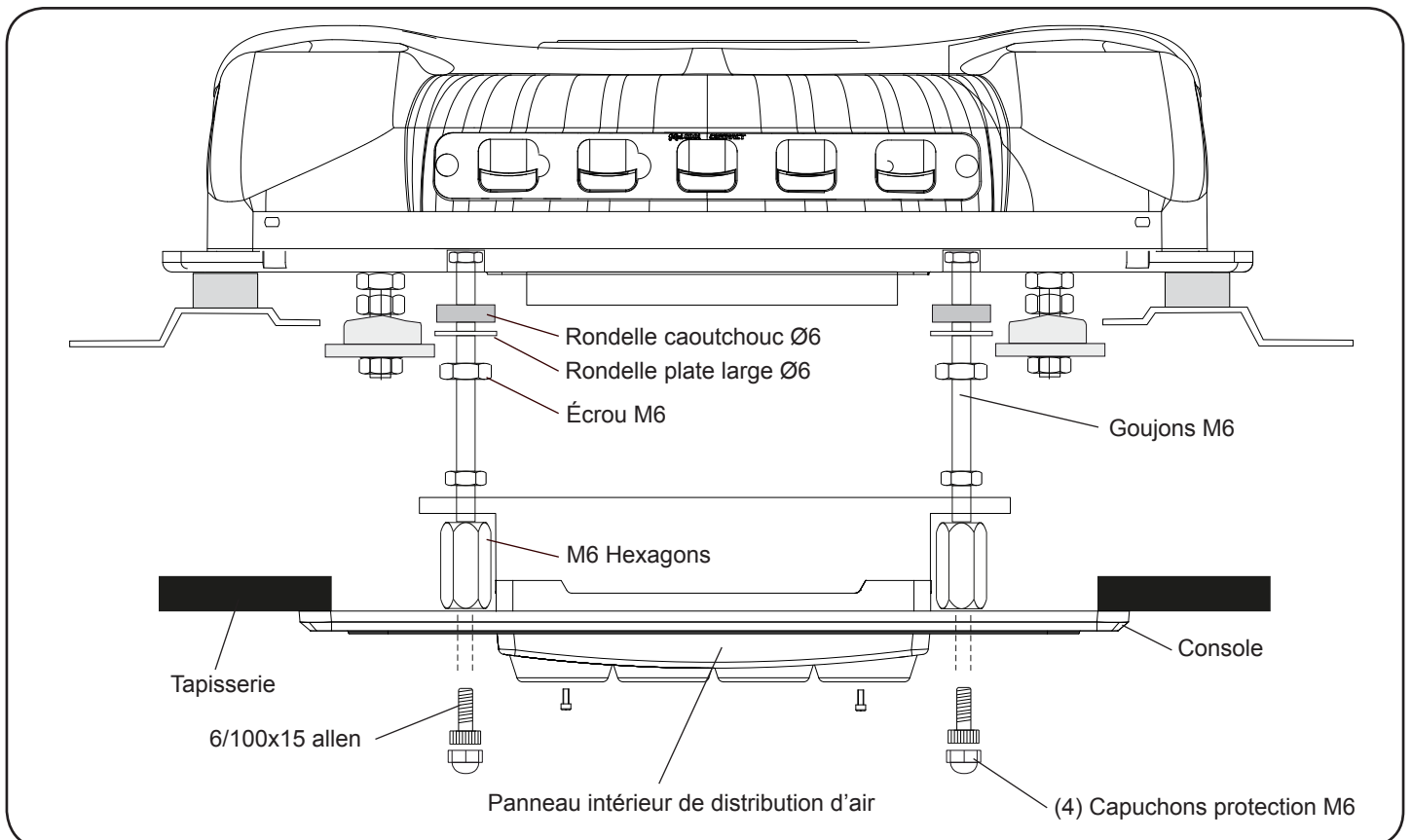

Instructions détaillées sur l'installation du câblage d'alimentation

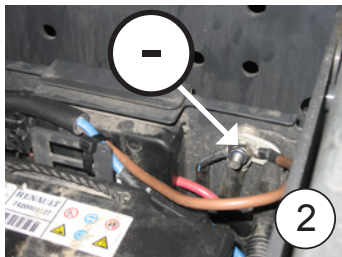
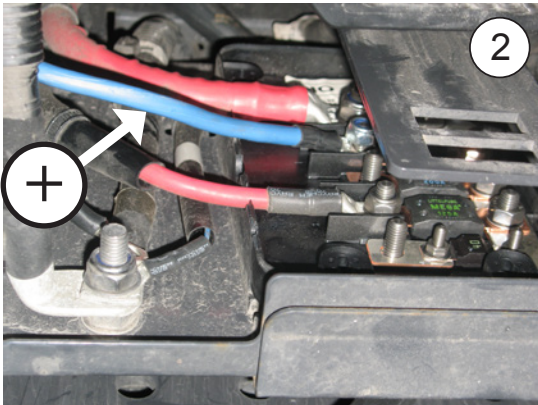

câble
d'alimentation
supérieur

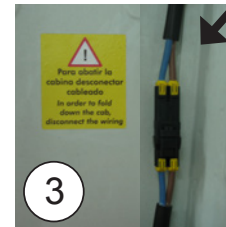

- 1- Connecter le câble d'alimentation supérieur à la partie arrière de l'appareil et le conduire par la partie postérieure de la cabine en collant les supports en plastique et en le fixant avec des brides.
- 2- Connecter le câble d'alimentation inférieur à la Une caisse de fusibles + et au centre de masses- , en le conduisant par le passage de câblage original, fixé avec des brides, vers la partie postérieure de la cabine, afin de connecter au câble d'alimentation supérieur.

LORS DU BRANCHEMENT DES CÂBLAGES, LAISSER LA DISTANCE PERTINENTE AFIN D'EVITER LEUR RUPTURE DUE AUX MOUVEMENTS DE LA CABINE!

IMPORTANT : étant donné la complexité du système de réglage électronique de l'équipement, la prise de courant doit être effectuée directement aux points indiqués de la boîte à fusibles.

Attention! Ne pas inverser les polarités dans la connexion de l'alimentation à l'équipement. Si cela se produisait, la plaque ne s'allumerait pas, l'équipement ne fonctionnerait pas et des dommages irréparables se produiraient sur les modules des compresseurs.

IMPORTANT: Pour la mise en marche, consulter le Manuel de l'Usager.

- 3- Placer des adhésifs de danger à l'union de câblage et sur le dispositif d'élévation de la cabine.

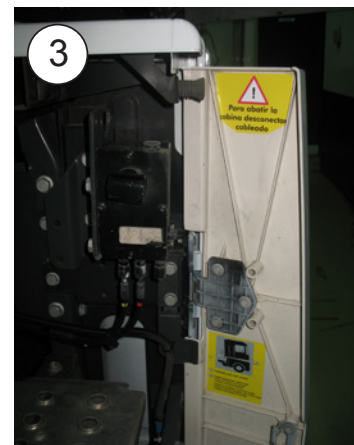

Câblage électrique

AVERTISSEMENT IMPORTANT!

Attention! Ne pas inverser les polarités dans la connexion de l'alimentation à l'équipement. Si cela se produisait, la plaque ne s'allumerait pas, l'équipement ne fonctionnerait pas et des dommages irréparables se produiraient sur les modules des compresseurs.

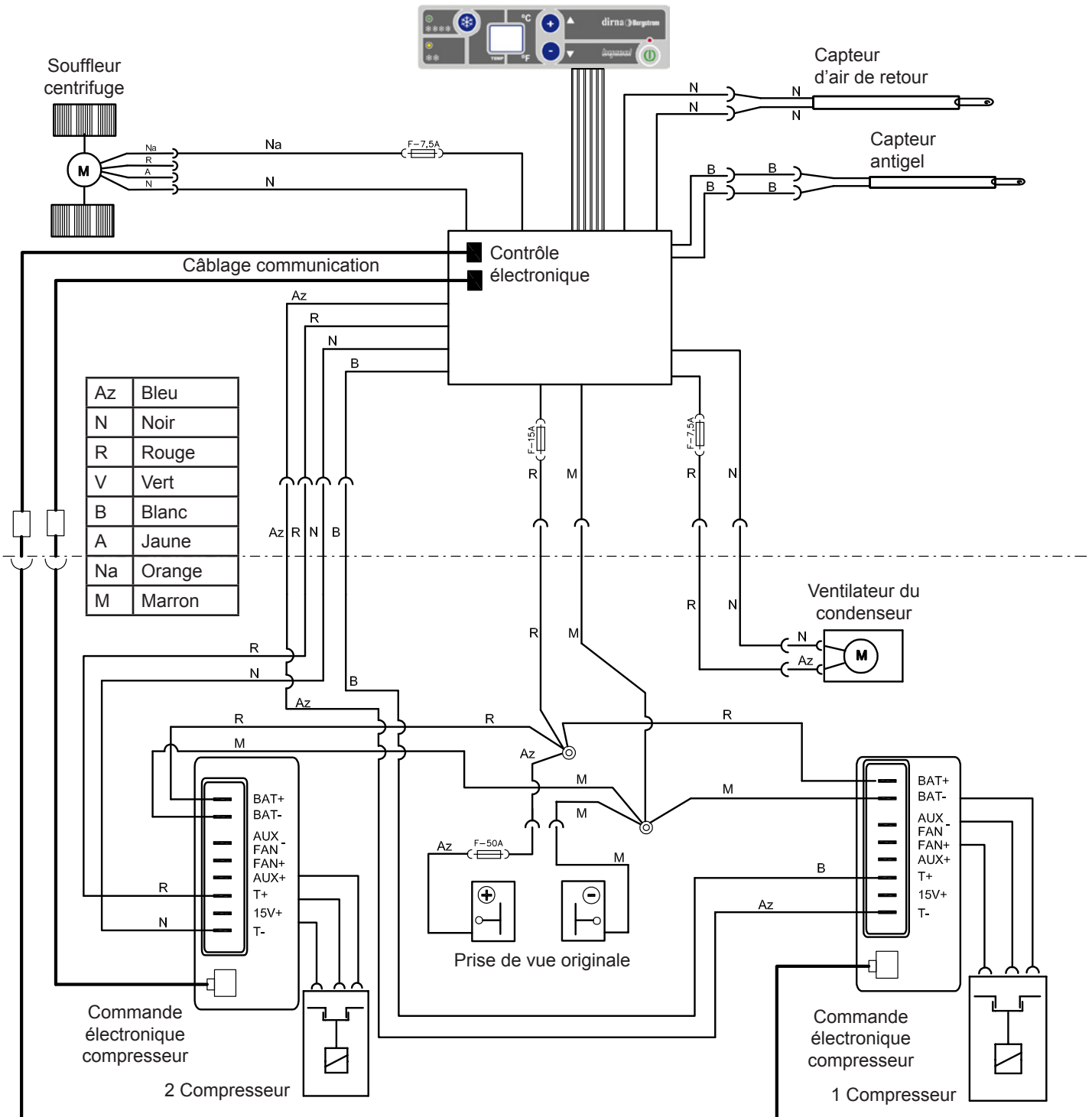

Empfehlungen Zur montage

- Vor und während der Montage bitte diese Anweisungen lesen und beachten.
- Benutzen Sie für jeden Arbeitsschritt die geeigneten Werkzeuge.

Elektrizität

- Zündschlüssel abziehen.
- Vor Montagebeginn die Batterie abklemmen.
- Den ordnungsgemäßen Anschluss und die korrekte Installation der Elektrokomponenten überprüfen.

Achtung

Sollte sich das Gerät während der Montage neigen, muss man mindestens 60 Minuten warten, nachdem es wieder in die horizontale Lage gebracht wurde, um es wieder einzuschalten.

Achtung

Wird die Klimaanlage im Kabinendach installiert, muss der obere Teil der Kabine mit einem Tuch oder einer Decke gegen eventuelle Kratzer geschützt werden. Bei der Installation der **Compact** auf dem Kabinendach muss darauf geachtet werden, dass mit Luken ausgestattete Kabinen über eine ausreichend stabile Struktur verfügen, um das Gewicht des Geräts stand zu halten. Sollte das Fahrzeug über keine Luke verfügen und sollte es notwendig sein, das Kabinendach aufzuschneiden, bzw. sollte die vorhandene Struktur nicht ausreichend stabil sein (z.B. wenn sie aus Faser, Kunststoff usw. hergestellt ist), obliegt es dem Installateur zu entscheiden, ob das Kabinendach zur Vermeidung von Verformungen, Brüchen, undichten Stellen usw. verstärkt werden muss, und die hierfür notwendigen Mittel bereit zu stellen.



Werkzeuge

- Torx-Schraubenschlüssel
- Inbusschraubenschlüssel
- 10er, 13er, 14er Schraubenschlüssel
- Schere
- Metermaß





Mitgelieferte unterlagen

Montageanweisungen	1001443781
Benutzerleitfaden	1001218019
Fehlerdiagnose	1001218025
Garantie	220AA10017

Symbologie

-  Fragile
-  Attention aux coupures !
-  Risque électrique

Warnhinweise

-  Der Installateur muss im Bereich Fahrzeug-Klimaanlagen ausreichend geschult sein.
-  **dirna Bergstrom, s.l.** übernimmt keine Verantwortung für Schäden oder Brüche aufgrund einer nicht ordnungsgemäßen Installation oder Bedienung des Geräts oder den Austausch von Teilen bzw. Umbauten, die ohne die erforderliche schriftliche Genehmigung durchgeführt wurden.
-  **Mit Kältemittel vorgefülltes Gerät.**
(Kältemittelkreislauf nicht manipulieren).
-  Siehe **Garantieverfahren** des Produkts in der **Fehlerdiagnose**.
-  Siehe **Benutzerleitfaden** des Geräts für den ordnungsgemäßen Betrieb der Fernbedienung und des Bedienfelds.
-  Die folgenden Unterlagen müssen dem Benutzer nach der Installation ausgehändigt werden:
Benutzerleitfaden, Garantie und Fehlerdiagnose.

 Vor Montabeginn vorderes Lufteintrittsgitter montieren.



1 Den Lukendeckel und die Befestigungselemente entfernen und dem Kunden aushändigen.



2 Vor dem Ankleben der EPDM-Dichtung die Klebstoffreste von der oberen Kabinenfläche entfernen.

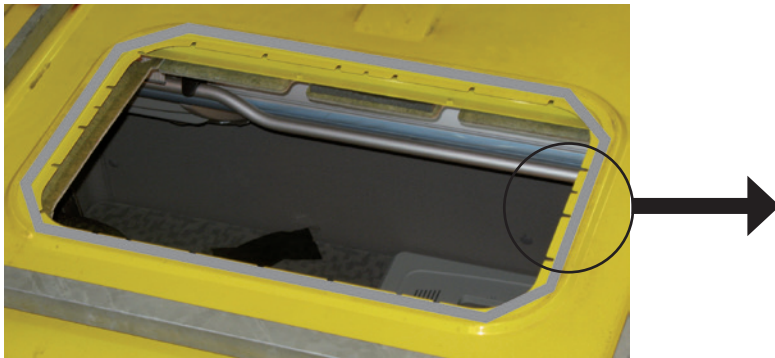

3 Coller le joint EPDM autour de l'orifice de l'écouille (um das detail zu schnitt die letzten grenzen der gewerkschaft der v ersammlung anzuschauen).





WIE DIE EPDM-DICHTUNG GESCHNITTEN WIRD, UM FILTRATIONEN IN DER KABINE ZU VERMEIDEN

- A- Dichtung aufkleben und dabei einen Papierschutz von 100 mm auf jeder Seite beibehalten.
- B- Die zwei Papierstücke entfernen.
- C- Unter Anpressen beider Enden aufkleben.

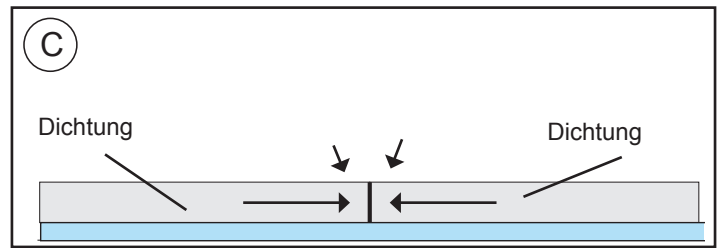
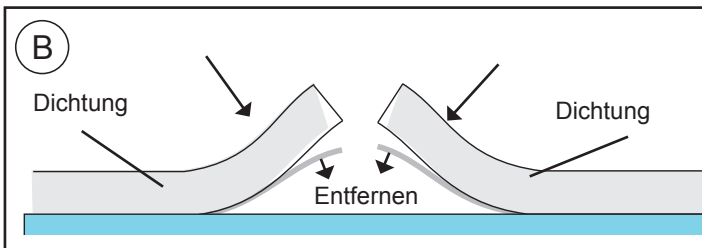
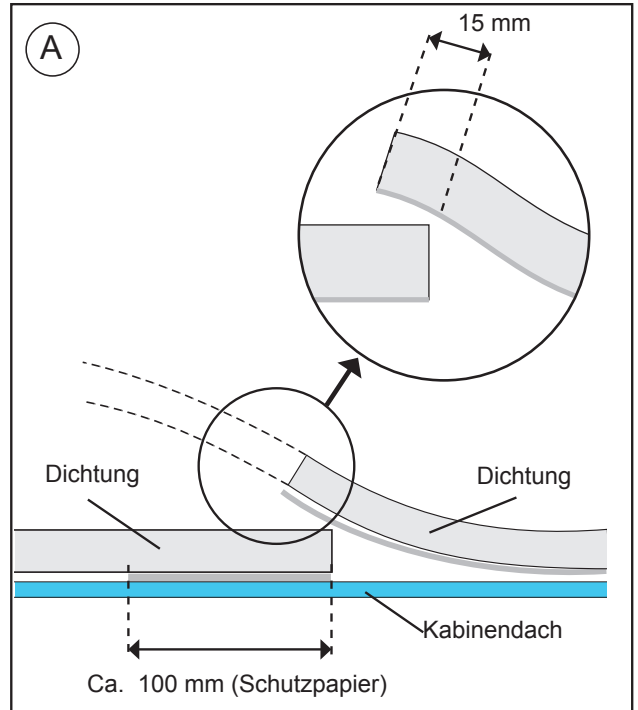

4

KABINENAUSSENSEITE:

Compact in der Öffnung positionieren.
Achtung! Beim Auflegen des Geräts auf die Lukenaussparung darauf achten, dass die Ablassausgänge nicht von der EPDM-Dichtung zusammengedrückt werden.



4

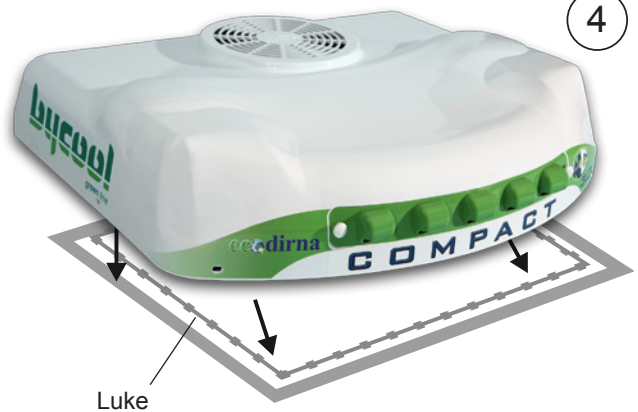

5

Schaumgummidurchführung anbringen, wobei der weichere Teil auf der Gerätegrundplatte aufliegt.

Achtung: Je nach Kabine kann es erforderlich sein, die (2) mitgelieferten Führungen zu verwenden, damit die Luftverteiltertafel ordnungsgemäß ausgerichtet ist.



6 **KABINENINNENSEITE:**
 Ca. 5 mm Gewinde für (4) Stiftschrauben 8/125x70, 100 oder 120 mm schneiden (abhängig vom größeren oder kleineren Abstand vom Gerät bis sie nach Positionierung der Befestigungsauflagen 20 mm unter diesen liegen).

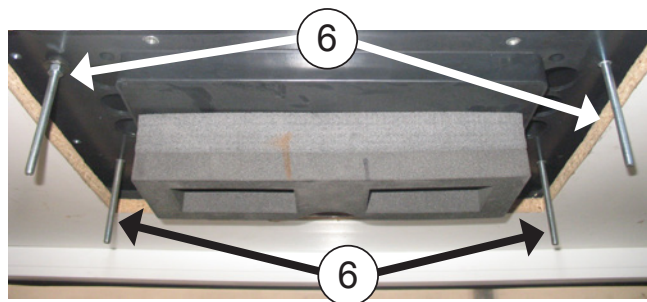
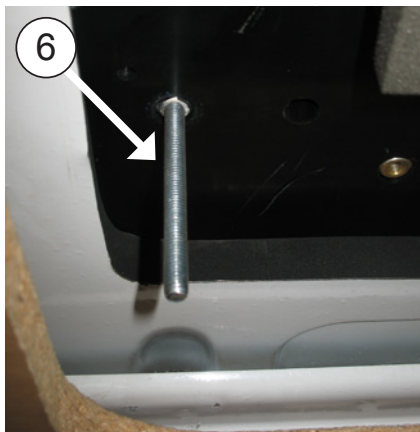
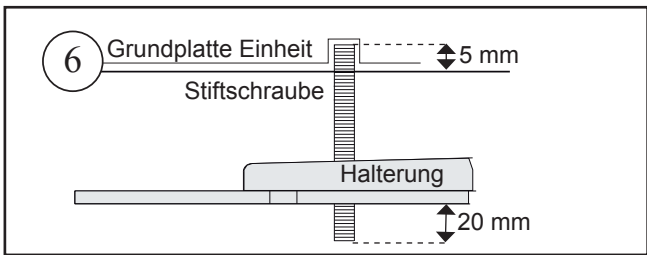

7 Montieren Sie wie folgt:
 Gummischeibe / 3D Unterlegscheibe / Mutter / Gewindestange.

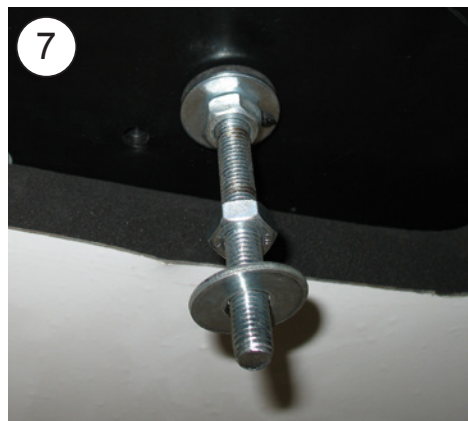

8 Befestigungsauflagen (2) mit einer Unterlegscheibe (1) und einer Autobloc-Mutter (1) M8 einlegen, **jedoch ohne anzuziehen**.

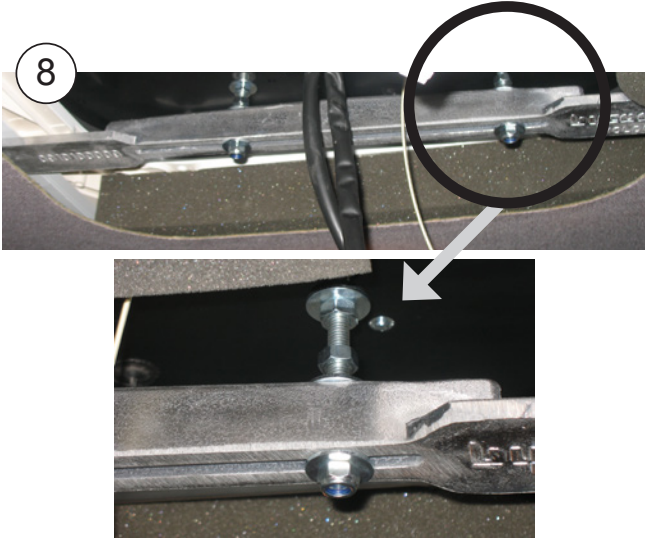

9 10 mm Gewinde für die Stiftschrauben (4) M6 x 80 am angegebenen Punkt schneiden laut Distanz (D) beschrieben in Abbildung 18.

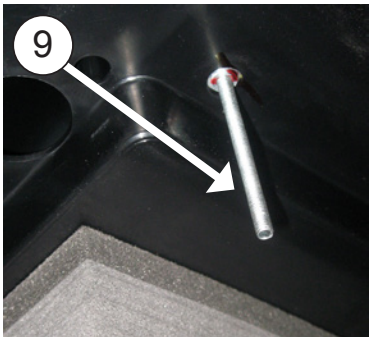
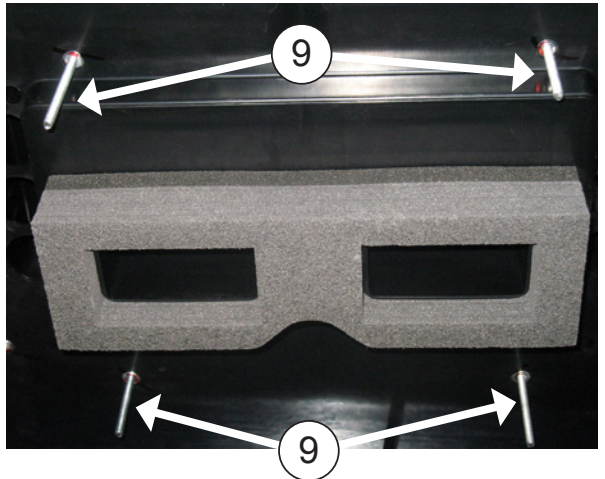

10 Montiere (1) Gummi-Unterlegscheibe, (1) 3D Unterlegscheibe (1) Mutter auf jede Gewindestange. Später ziehen Sie die Mutter an, bis die Gummischeibe ein wenig zusammengedrückt ist.

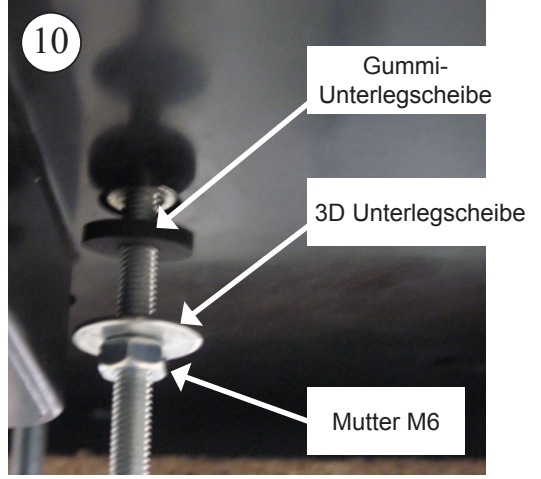

11 Jeweils die Mutter (1) M6 **ohne Anziehen** auf die Stiftschrauben legen.

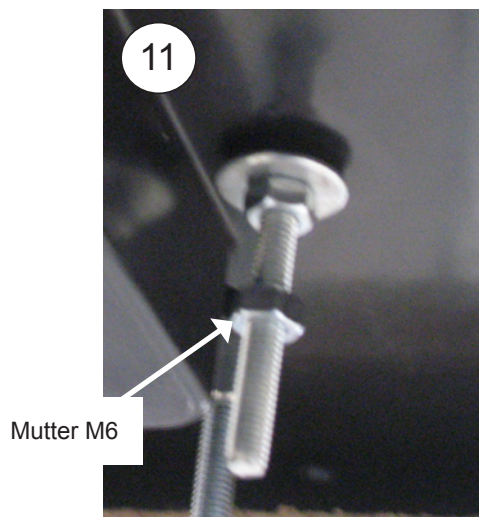

12 Zwischen der Grundplatte und der inneren Luftverteiltertafel (2) 2-Wege-Kästen von Frostschutzfühler (weiße Kabel) und Rückführsonde (schwarze Kabel), 4-Wege-Kasten des Gebläses, (2) Kommunikationskabel und 8-Wege-Kasten der Anschlussverkabelung zur Elektroniksteuerung anschließen.

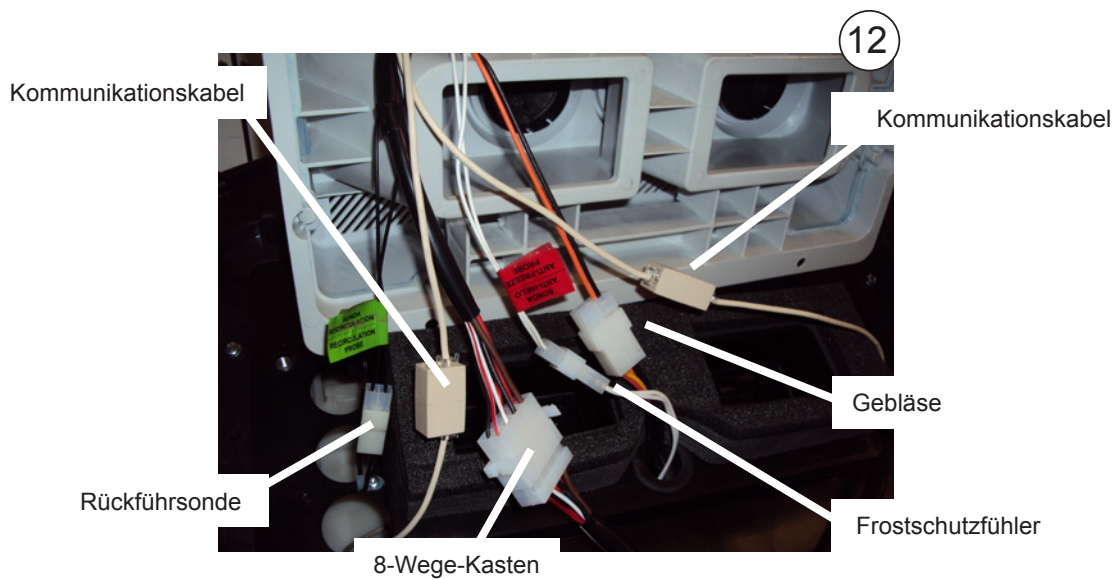

13

Innere Luftverteiltertafel an den vorgenannten Stiftschrauben mit jeweils einem Sechskant-Distanzstück M6x25 anbringen.

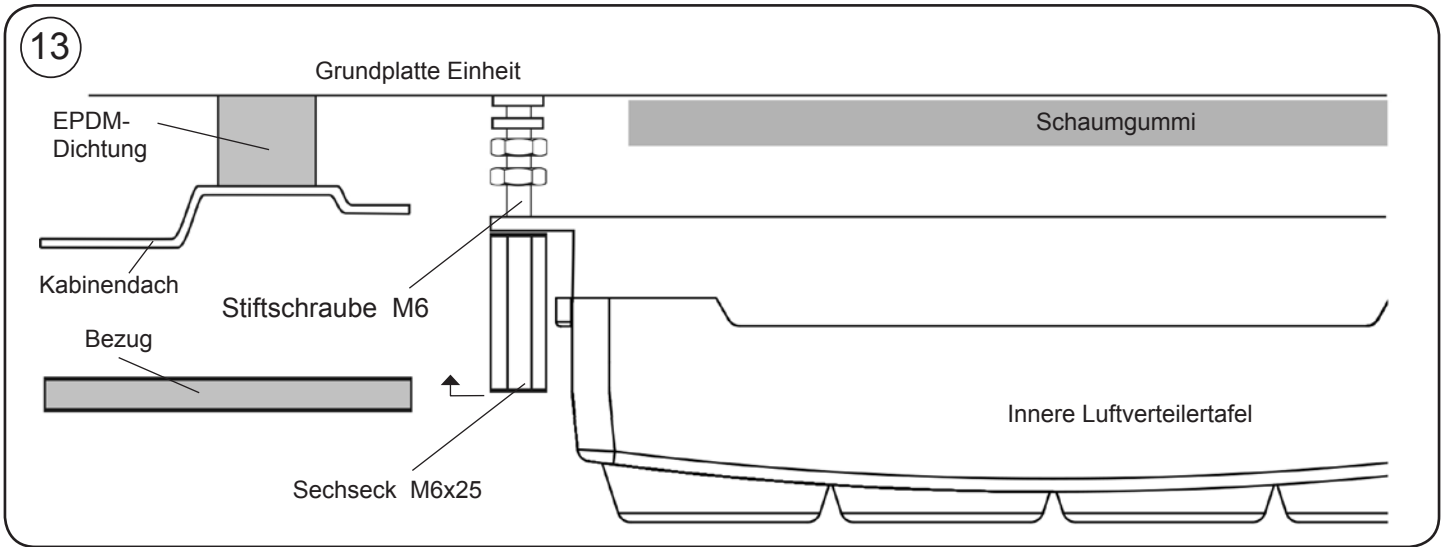

14

Die für das Fahrzeugmodell geeignetste Konsole auflegen und die Anlage an der hierfür gewählten Stelle der Kabinendecke zentrieren. Nach dem Zentrieren Konsole entfernen.

Achtung: Wird die Konsole (*) gewählt, die (4) angegebenen Zapfen auf Höhe der Konsole abschneiden.

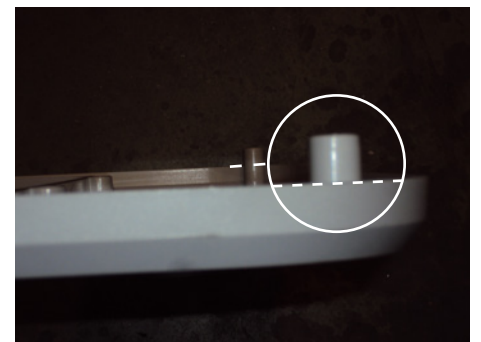
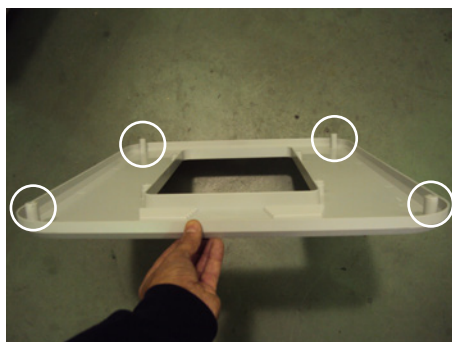
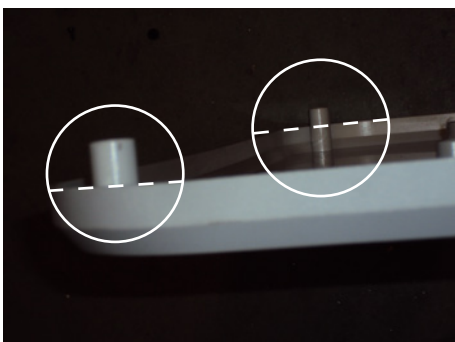

15

Die Halterungen durch Anziehen der Muttern befestigen, bis die EPDM-Dichtung (Punkt 3) des Geräts zwischen 3 und 6 mm komprimiert wird;

Wichtiger Hinweis: Um das Eindringen von Wasser in die Kabine zu verhindern, die die Verbindung der EPDM-Dichtung mit der Grundplatte des Compact wie in Schema gezeigt überprüfen.



16

Die Muttern (4) M8 (B) anziehen, um sie an der Grundplatte zu befestigen (C).

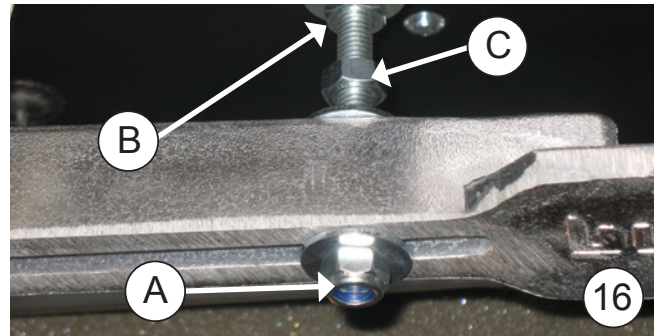
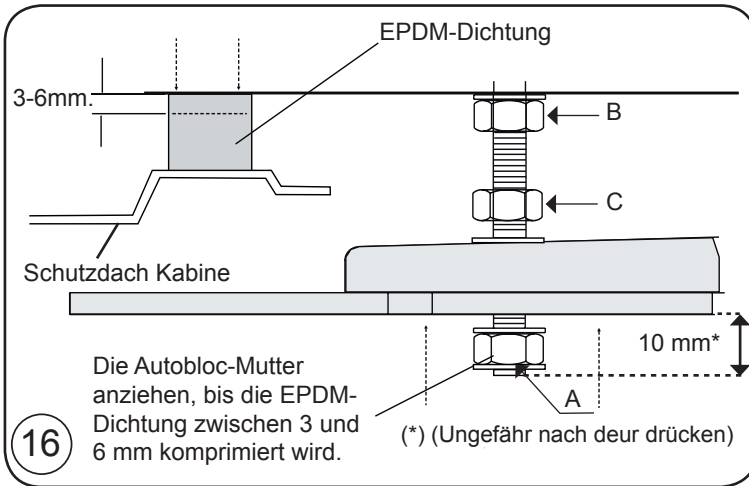

17

Sechskantschrauben anziehen, bis die Führungen ineinander einpassen.

18

Mutter aus Punkt 11 anziehen, bis diese an das Oberteil der inneren Luftverteiltertafel stößt.

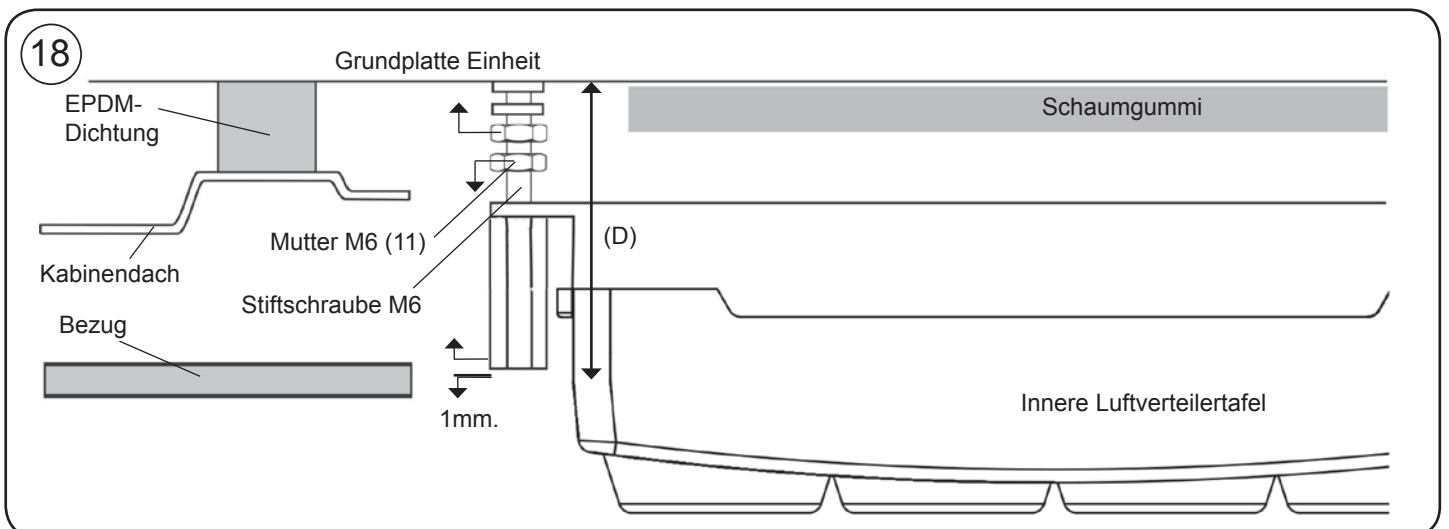

19

Die Konsole anhand von (4) Inbusschrauben M6/100x15 anbringen.

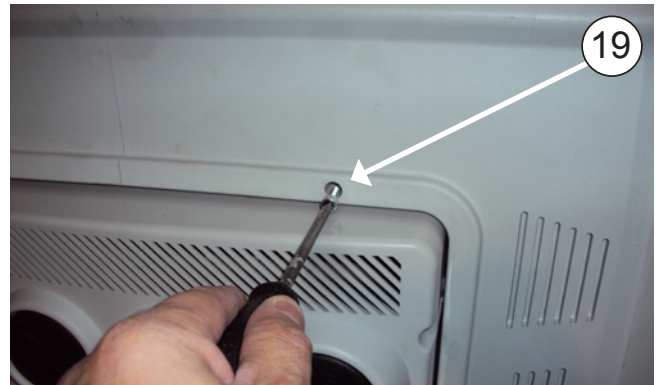

20

Die (4) Innensechskantschrauben M6/100x15 mit den runden Kunststoff-Zierkappen M6 abdecken.

Achtung: Bei der Konsole (*) ebenfalls die seitlichen Bohrlöcher (Y) abdecken.

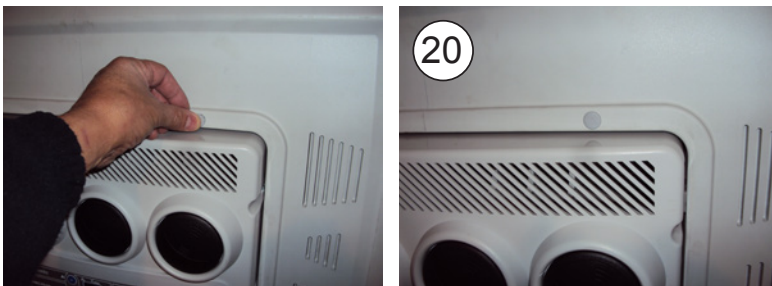

Explosionsansicht bis zur befestigung der befestigungsauflagen

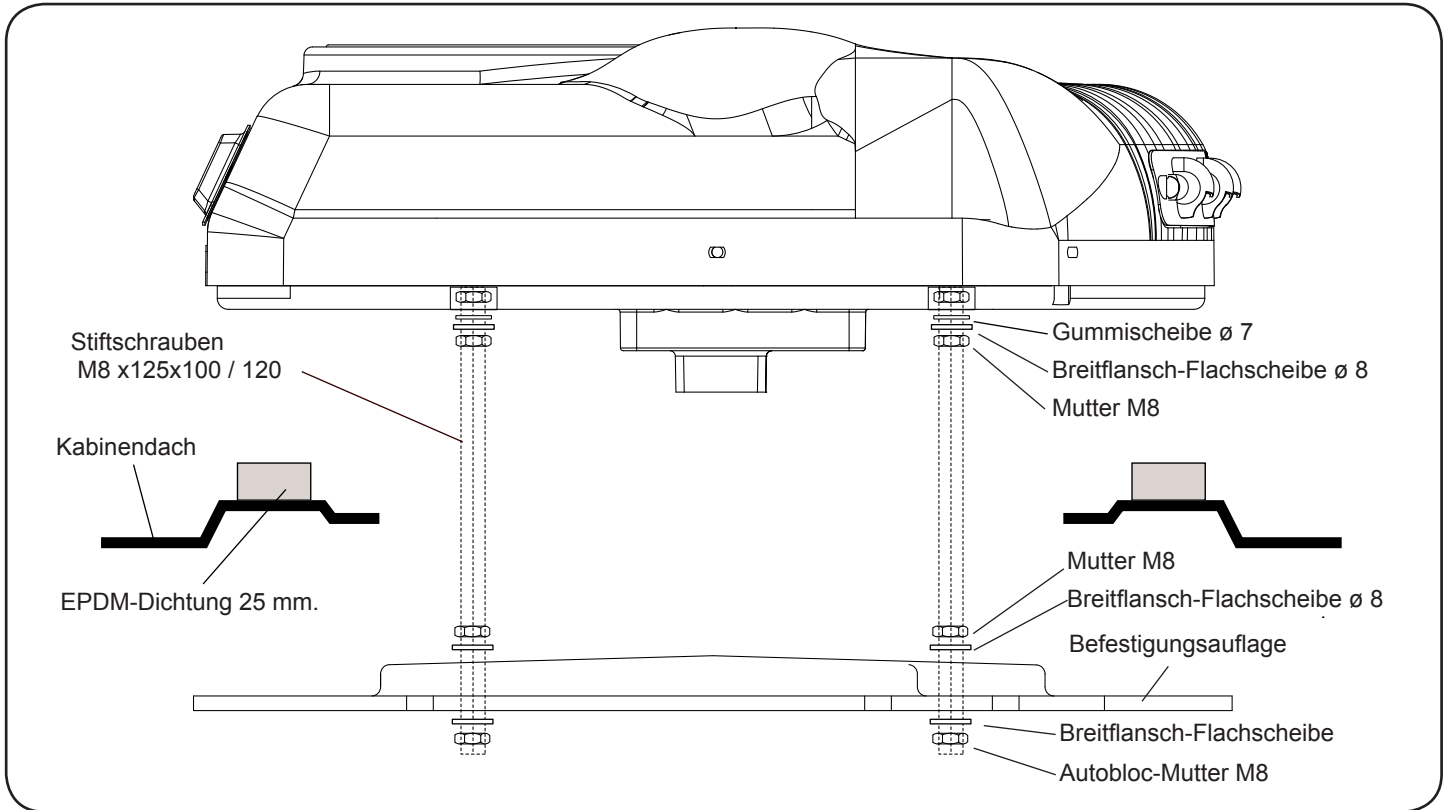

Explosionsansicht bis zur befestigung der konsolen

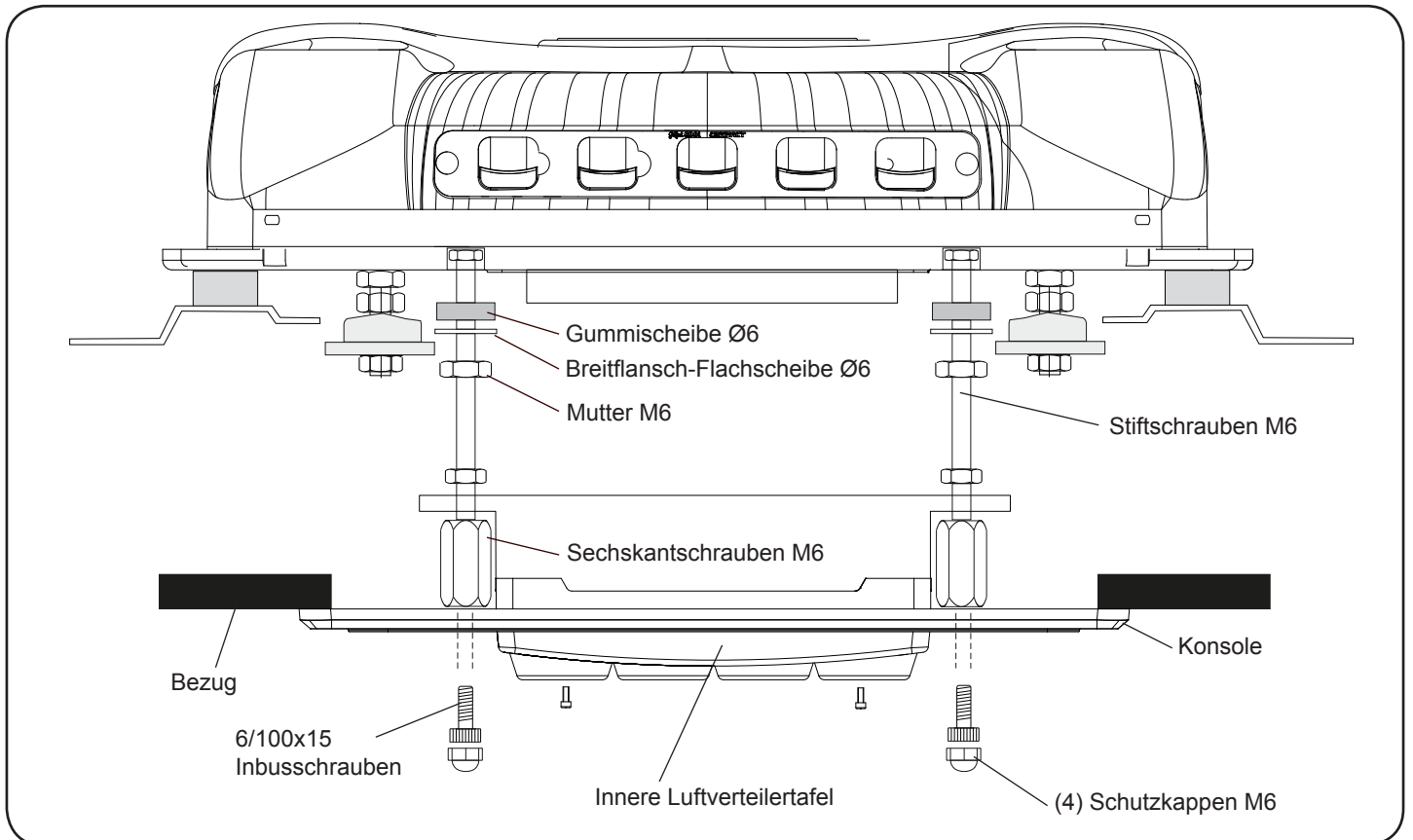

Ausführliche Einleitungen über die Installation der Verkabelungsleitung

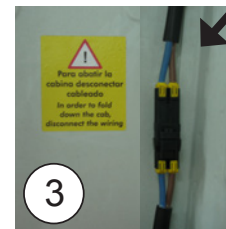
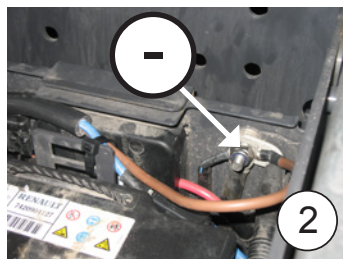
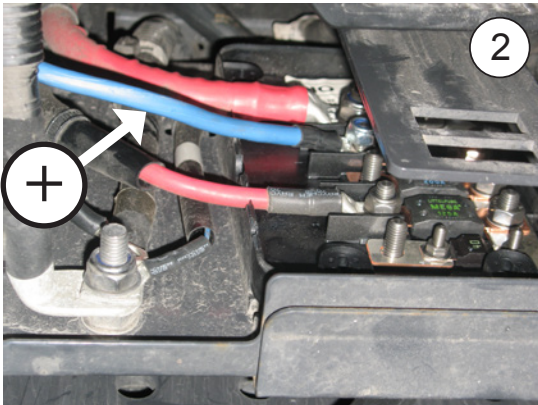

- 1- Oberes Stromversorgungskabel an die Rückseite des Geräts anschließen und um die Kabinenrückseite führen. Dabei die Kunststoffhalter ankleben und mit den Kabelbindern fixieren.
- 2- Unteres Stromversorgungskabel an die Kiste von schmelzbar das + und im Zentrum der Massen der eine - anschließen. Dieses durch den ursprünglichen Kabeldurchgang, befestigt mit Kabelbindern, hin zur Kabinenrückseite führen, um es mit dem oberen Stromversorgungskabel zu verbinden.

BEIM VERBINDEN DER KABEL, AUSREICHEND ABSTAND LASSEN, UM EINEN DURCH DIE KABINENBEWEGUNGEN BEDINGTEN BRUCH ZU VERMEIDEN!

WICHTIGER HINWEIS: Aufgrund der komplizierten elektronischen Steuerung des Geräts muss die Stromversorgung direkt an den gezeigten Punkten des Sicherungskastens erfolgen.

Darauf achten, dass die Polaritäten beim Anschluss der Stromversorgung an das Gerät nicht vertauscht werden. Ist dies der Fall, schaltet sich die Elektroniktafel nicht ein, das Gerät funktioniert nicht und es kommt zu irreparablen Schäden an den Kompressormodulen.

WICHTIG: Zur Inbetriebsetzung Bedienerhandbuch heranziehen.

- 3- Gefahrenkleber an Kabelverbindung und Kabinenhebevorrichtung anbringen.

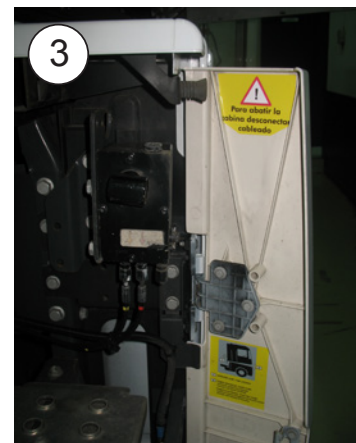

Elektrische Verkabelung

WICHTIGER WARHNHWEIS!

Darauf achten, dass die Polaritäten beim Anschluss der Stromversorgung an das Gerät nicht vertauscht werden. Ist dies der Fall, schaltet sich die Elektroniktafel nicht ein, das Gerät funktioniert nicht und es kommt zu irreparablen Schäden an den Kompressormodulen.

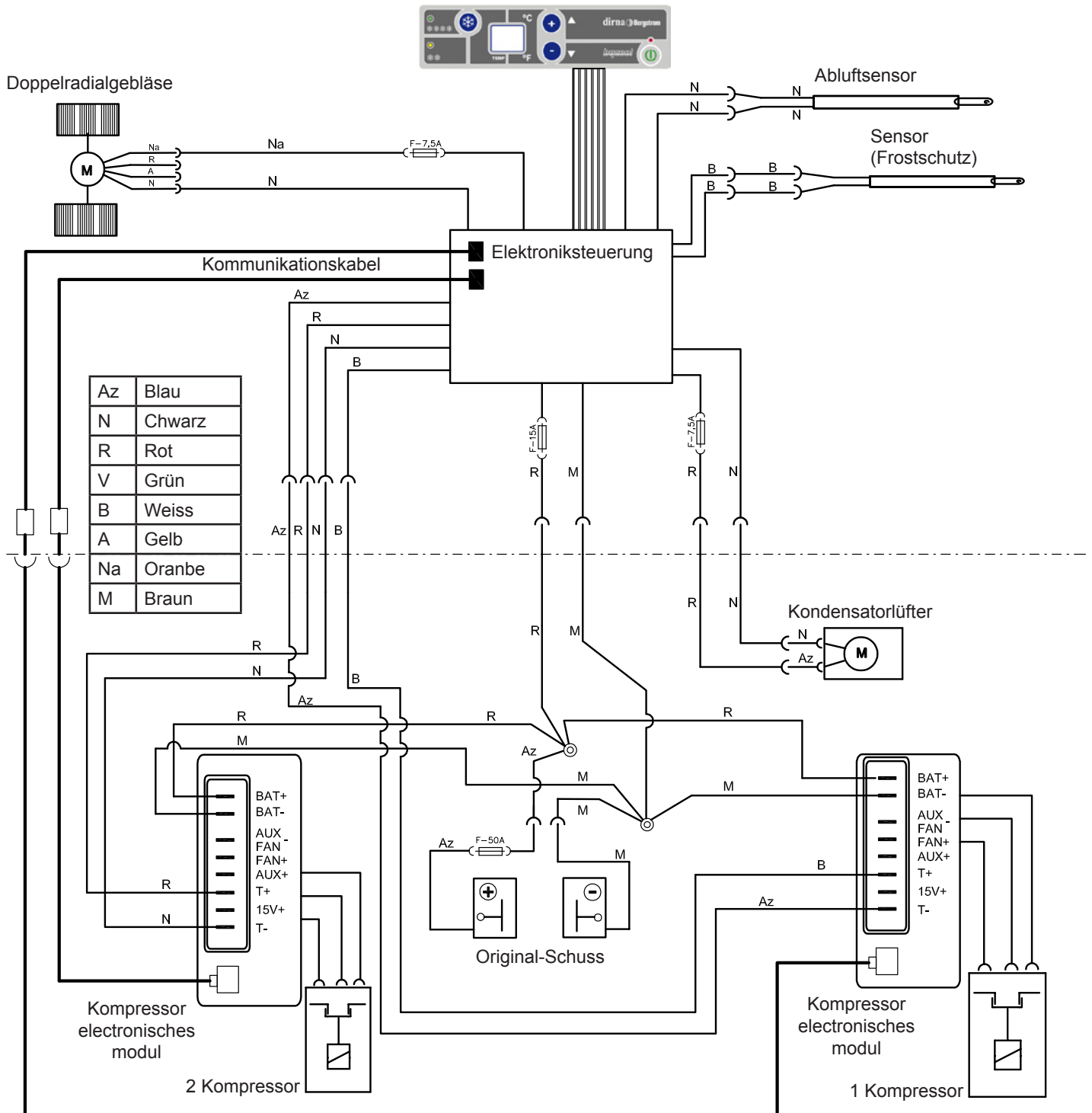

Suggerimenti per il montaggio

- Prima di cominciare il montaggio, leggere attentamente le istruzioni e rispettarle nel corso dello stesso.
- Usare gli attrezzi più adatti ad ogni operazione.

Elettricità

- Scollegare la chiave di contatto.
- Scollegare la batteria prima di cominciare il montaggio.
- Assicurarsi di aver effettuato correttamente l'installazione e il collegamento dei componenti elettrici.

Attenzione

Se durante il montaggio si inclina l'impianto, prima di rimetterlo in funzione occorre attendere almeno 60 minuti dal momento in cui è di nuovo in posizione orizzontale.

Attenzione

Quando si installa l'impianto di aria condizionata sul tettuccio, bisogna proteggere la parte superiore della cabina con uno straccio o una coperta per evitare eventuali graffi. Per l'installazione del **Compact**, tenere presente che normalmente le cabine munite di oblò dispongono di una struttura abbastanza solida per sostenere il peso dell'impianto. Tuttavia, se così non fosse e se fosse necessario tagliare il tettuccio, o se in presenza di oblò la struttura non fosse abbastanza rigida (se fosse di fibra, plastica, ecc.), è responsabilità dell'installatore decidere se occorre rinforzare il tettuccio per evitare qualsiasi deformazione, rottura o penetrazione d'acqua, ecc., prendendo le misure necessarie per evitarlo.

Attrezzi

Kit di chiavi Torx
 Kit di chiavi Allen
 Chiave fissa 10, 13, 14
 Forbici
 Metro a nastro

Documentazione allegata

Istruzioni di montaggio	1001443781
Guida dell'utente	1001218019
Soluzione dei problemi	1001218025
Garanzia	220AA10017

Simbologia



Fragile









Attenzione alle mani



Tensione elettrica pericolosa

Avvertenze

-  L'installatore deve essere in possesso della formazione necessaria in materia di aria condizionata per veicoli.
-  **dirna Bergstrom, s.l.** declina ogni responsabilità per danni o rotture derivanti dall'errata installazione o dall'errato uso dell'impianto o da sostituzioni o modifiche effettuate senza la necessaria autorizzazione per iscritto.
-  **Impianto precaricato con gas refrigerante. (Non manomettere il circuito di gas refrigerante).**
-  Vedi la **procedura di garanzia** del prodotto in **Diagnosi dei problemi**.
-  Vedi la **Guida dell'utente** dell'impianto per il corretto funzionamento del telecomando e del pannello di controllo.
-  I seguenti documenti devono essere consegnati all'utente una volta conclusa l'installazione: **Guida dell'utente, Garanzia e Diagnosi dei problemi**.

 Prima di iniziare il montaggio, installare la griglia sull'entrata anteriore dell'aria.



1 Smontare il coperchio dell'oblò, gli elementi di fissaggio e consegnarli al cliente.



2 Eliminare i residui di adesivo dalla superficie superiore della cabina prima di incollare la guarnizione EPDM.

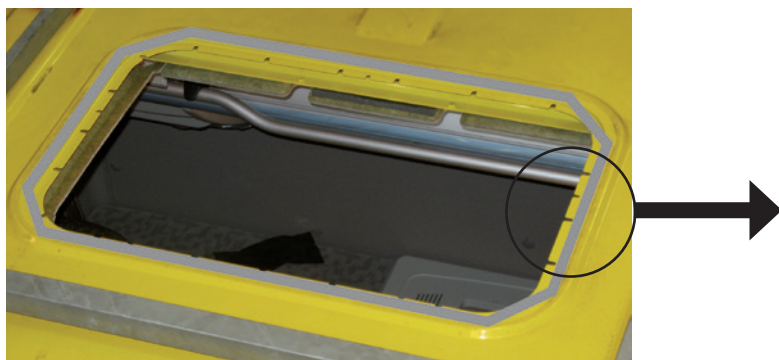

3 Incollare la guarnizione EPDM intorno al foro dell'oblò (vedi particolare per tagliare i bordi).





COME TAGLIARE LA GUARNIZIONE EPDM PER EVITARE INFILTRAZIONI NELLA CABINA

- A- Incollare la guarnizione mantenendo una protezione di carta di 100 mm su ogni lato.
- B- Rimuovere i due pezzi di carta.
- C- Incollare premendo su entrambe le estremità.

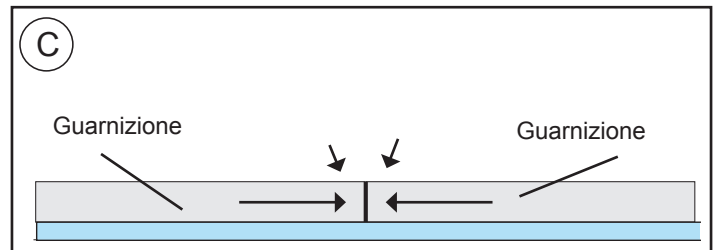
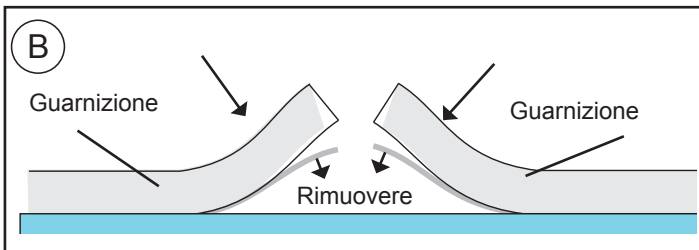
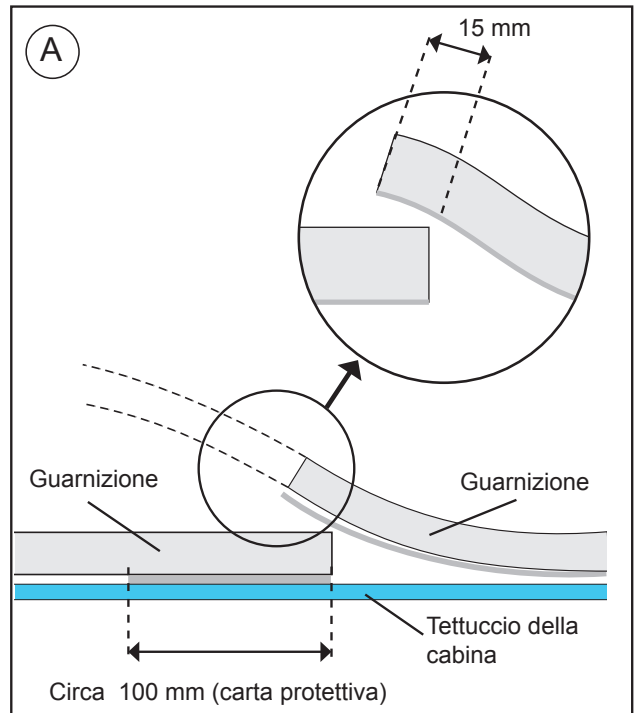

4

ESTERNO CABINA:

Inserire il Compact nel vano.

Attenzione! Quando si posiziona l'impianto sul vano del tettuccio apribile, controllare che le uscite di scarico non siano ostruite dalla guarnizione EPDM.

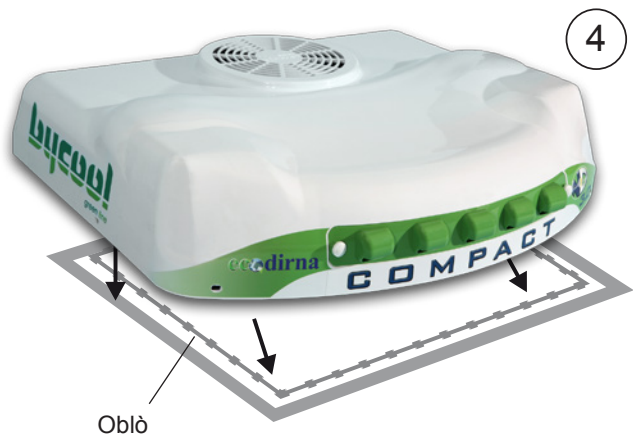

5

Posizionare il canalizzatore di gommapiuma con la parte più morbida sulla base dell'impianto.

Attenzione: A seconda della cabina, può essere necessario usare i (2) canalizzatori in dotazione per la completa adesione del pannello di distribuzione dell'aria ai medesimi.



6

INTERNO CABINA:

Avvitare di circa 5 mm le (4) viti prigioniere da 8/125x70, 100 o 120 mm, a seconda della distanza (maggiore o minore) dall'impianto finché, posizionando i supporti di fissaggio, le viti non sporgono di 20 mm dagli stessi.

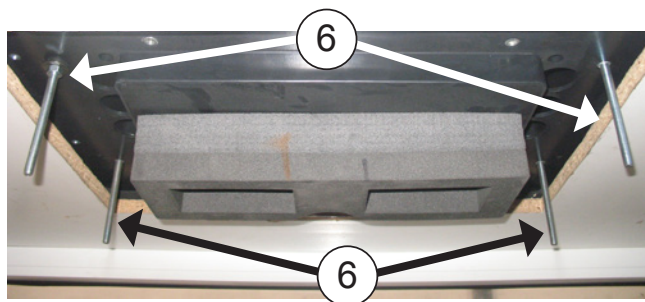
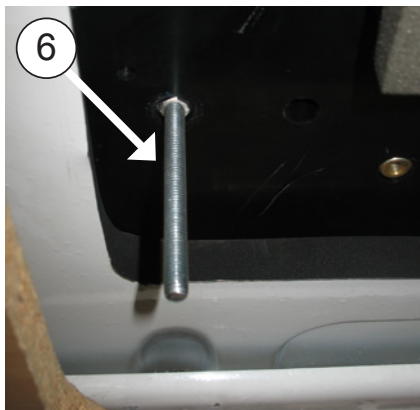
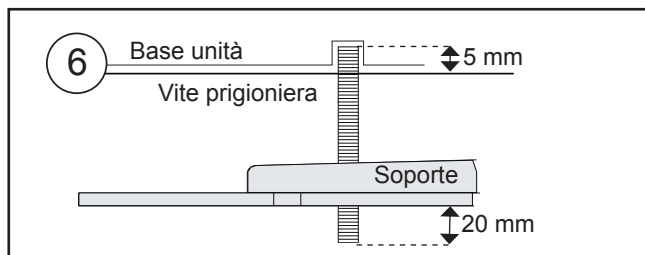

7

Inserire (8) rondella di gomma Ø 7, (1) rondella piana Ø 1 a testa larga, (2) dadi M8 e (1) rondella piana Ø 8 a testa larga, su ciascuna vite prigioniera precedente, seguendo questo ordine.

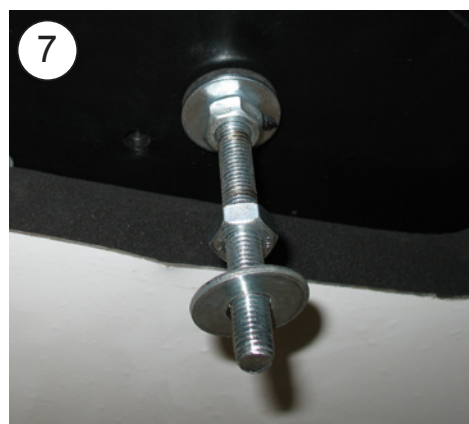

- 8** Fissare i supporti di fissaggio (2), con una rondella (1) e un dado autobloccante (1) M8, senza stringere.

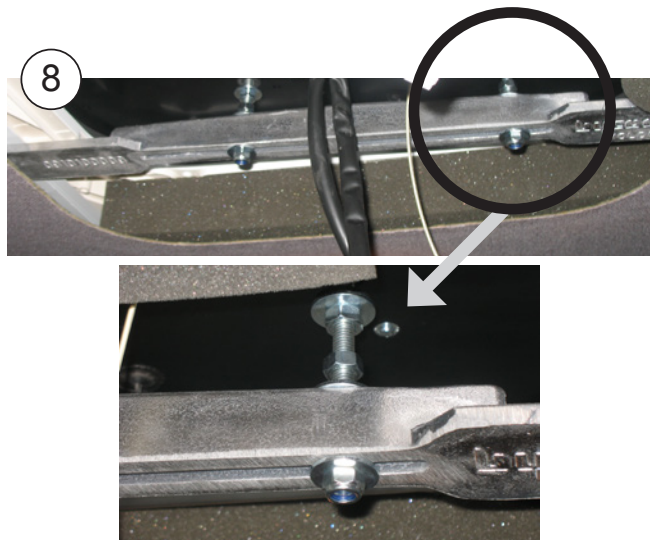

- 9** Avvitare di 10 mm i perni (4) M6 x 80, dove indicato distanza (A) segun nella a figura 18.

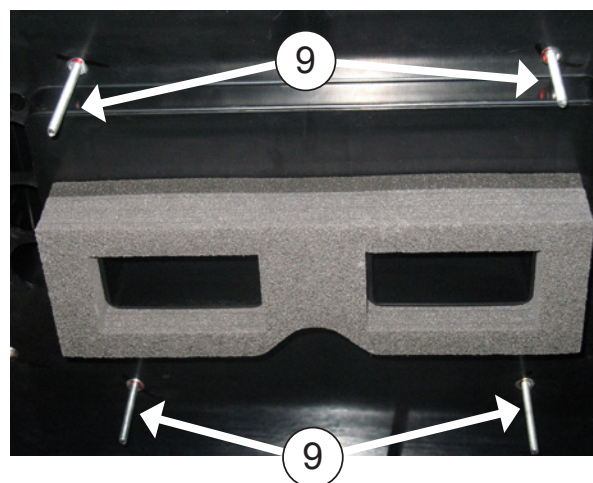

- 10** Inserire (1) rondella Ø 6 di gomma, (1) rondella piana Ø 6 a testa larga e (1) dado M6 su ogni vite prigioniera M6. Quindi stringere il dado fino a premere leggermente la rondella di gomma.

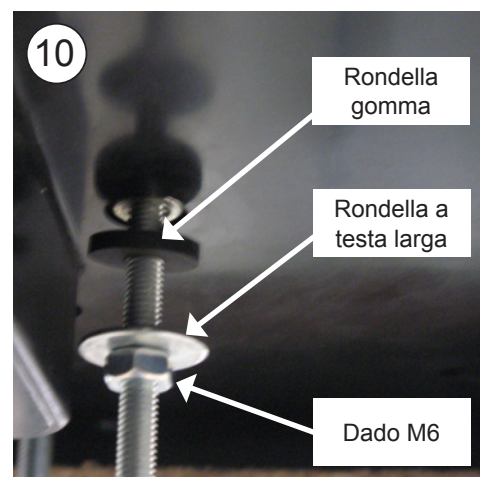

11

Inserire il dado (1) M6 senza stringere in ogni vite prigioniera.

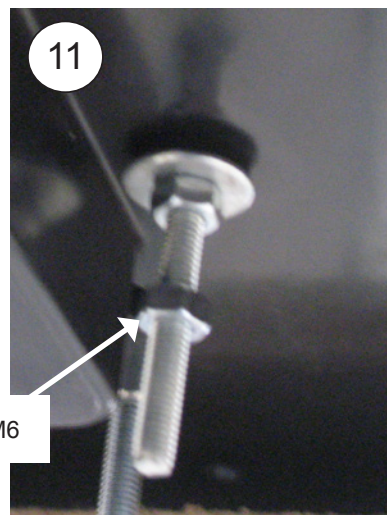

Dado M6

12

Tra la base e il pannello interno di distribuzione dell'aria, collegare (2) scatole a due vie del sensore antigelo (cavi bianchi) e del sensore dell'aria di ritorno (cavi neri), la scatola a 4 vie del ventilatore, (2) cavi di comunicazione e la scatola a 8 vie del cablaggio di connessione con il controllo elettronico.

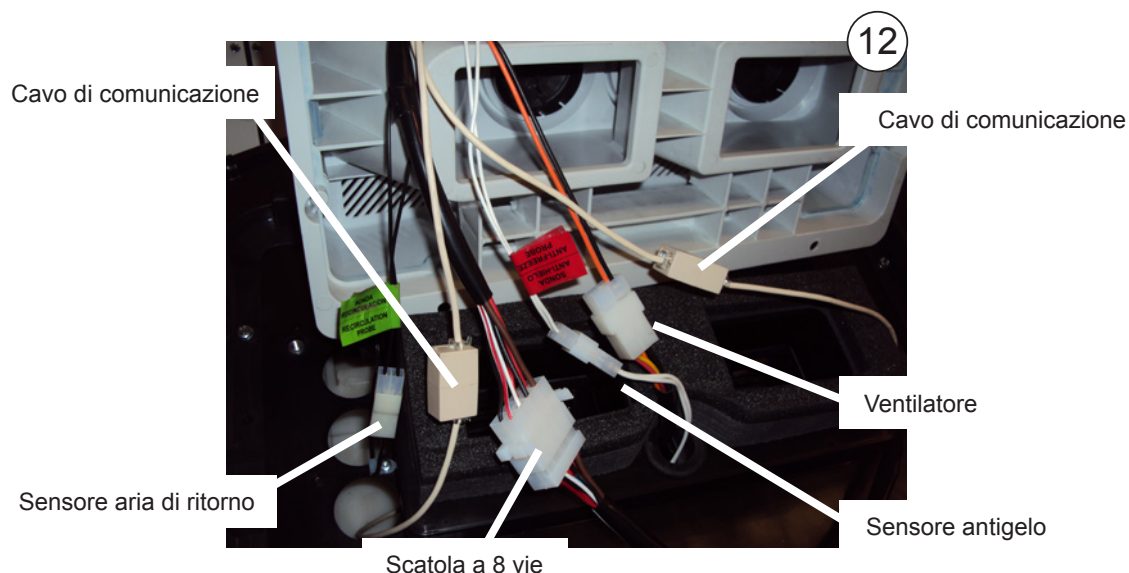

13

Inserire il pannello interno di distribuzione dell'aria sulle viti prigioniera anteriori con un distanziatore esagonale M6x25 su ogni vite prigioniera.

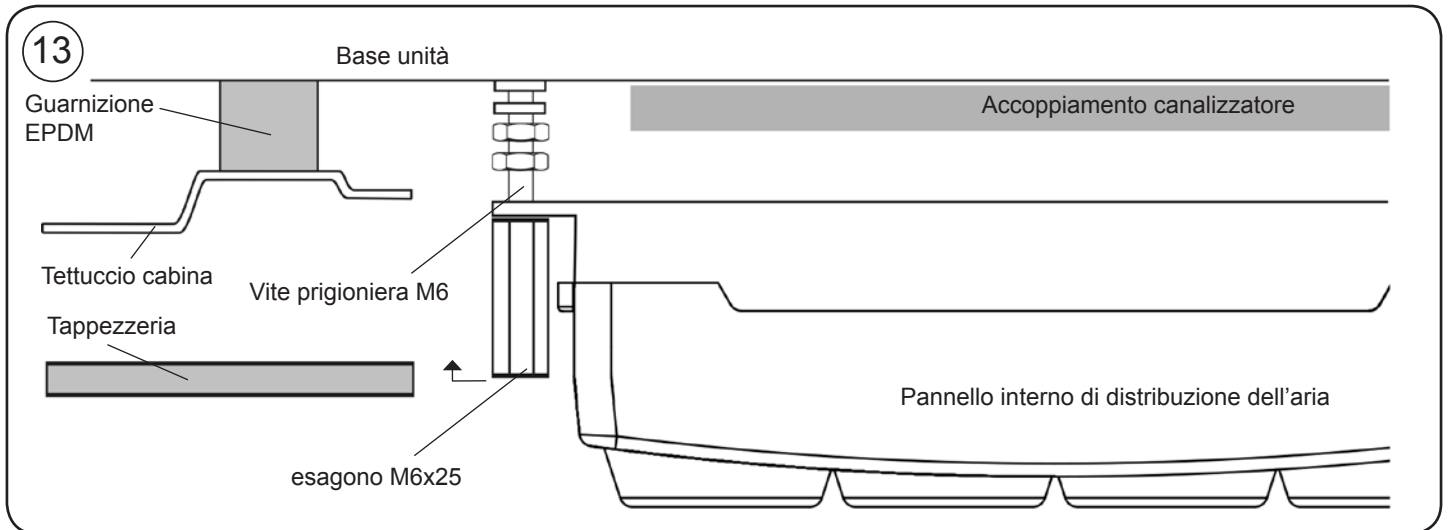

14

Posizionare provvisoriamente la console più adatta al modello di veicolo e centrare l'impianto nel sito più opportuno del tettuccio della cabina. Una volta centrato, rimuovere la console.

Attenzione: se si sceglie la console (*), tagliare i (4) piedini indicati a filo della consola.

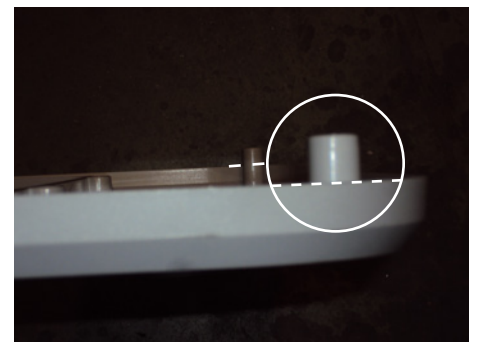
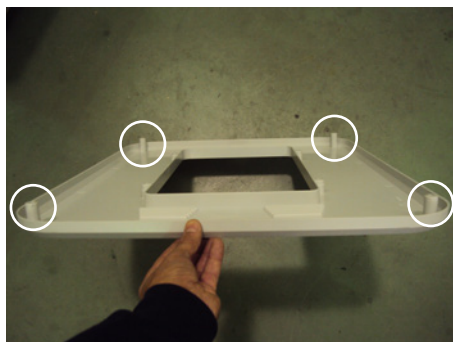
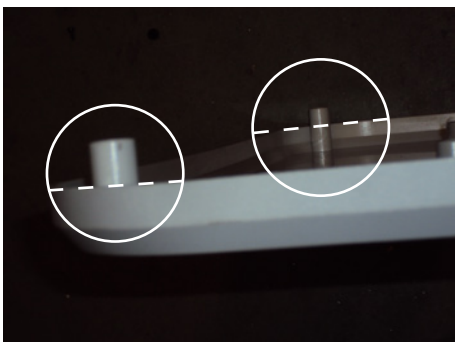
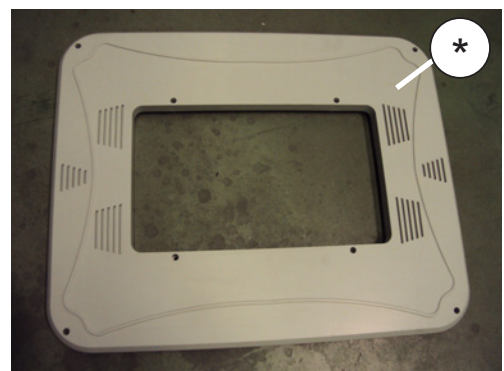

15

Fissare i supporti stringendo i dadi (A) fino a comprimere, tra 3 e 6 mm, la guarnizione EPDM (**Punto 3**) dell'impianto;

Nota bene: Per evitare che infiltrazioni d'acqua nella cabina, verificare il serraggio della guarnizione EPDM con la base Compact base, come illustrato nel Diagramma.



16

Stringere i dadi (4) M8(B) per fissare a (4) (C) l'unità base.

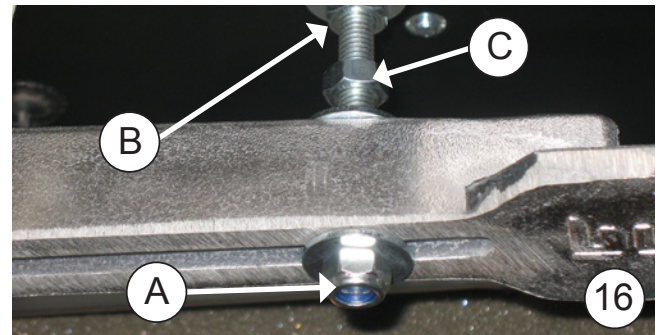
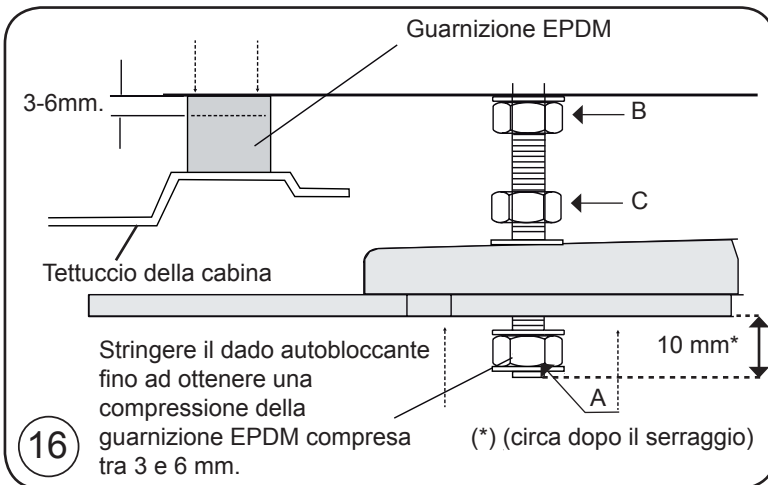

17

Stringere le viti esagonali fino ad allineare i canalizzatori tra di loro.

18

Stringere il dado del punto 11 fino a battuta con la parte superiore del pannello interno di distribuzione dell'aria.

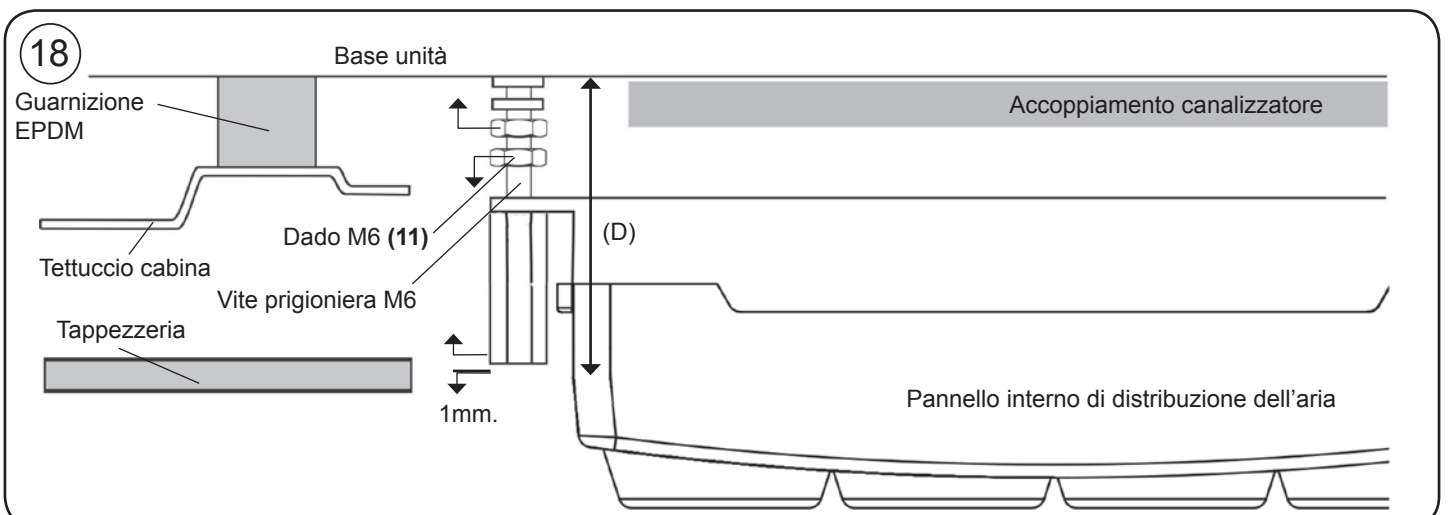

19

Posizionare la consolle usando (4) viti a brugola M6/100x15.

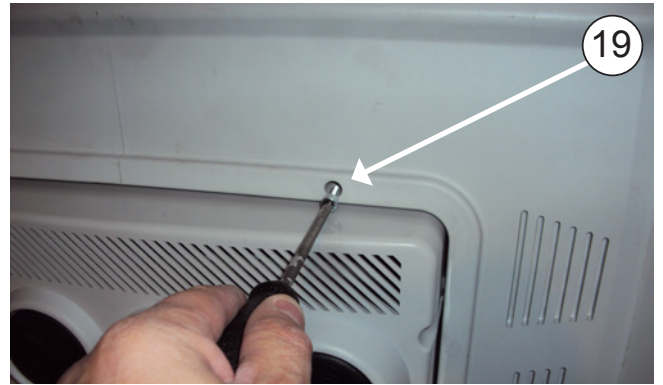

20

Coprire le (4) viti M6/100x15 a brugola con gli elementi decorativi rotondi M6 in plastica.

Attenzione: con la console (*), coprire anche i fori laterali (Y).



Esploso fino al fissaggio dei supporti di fissaggio

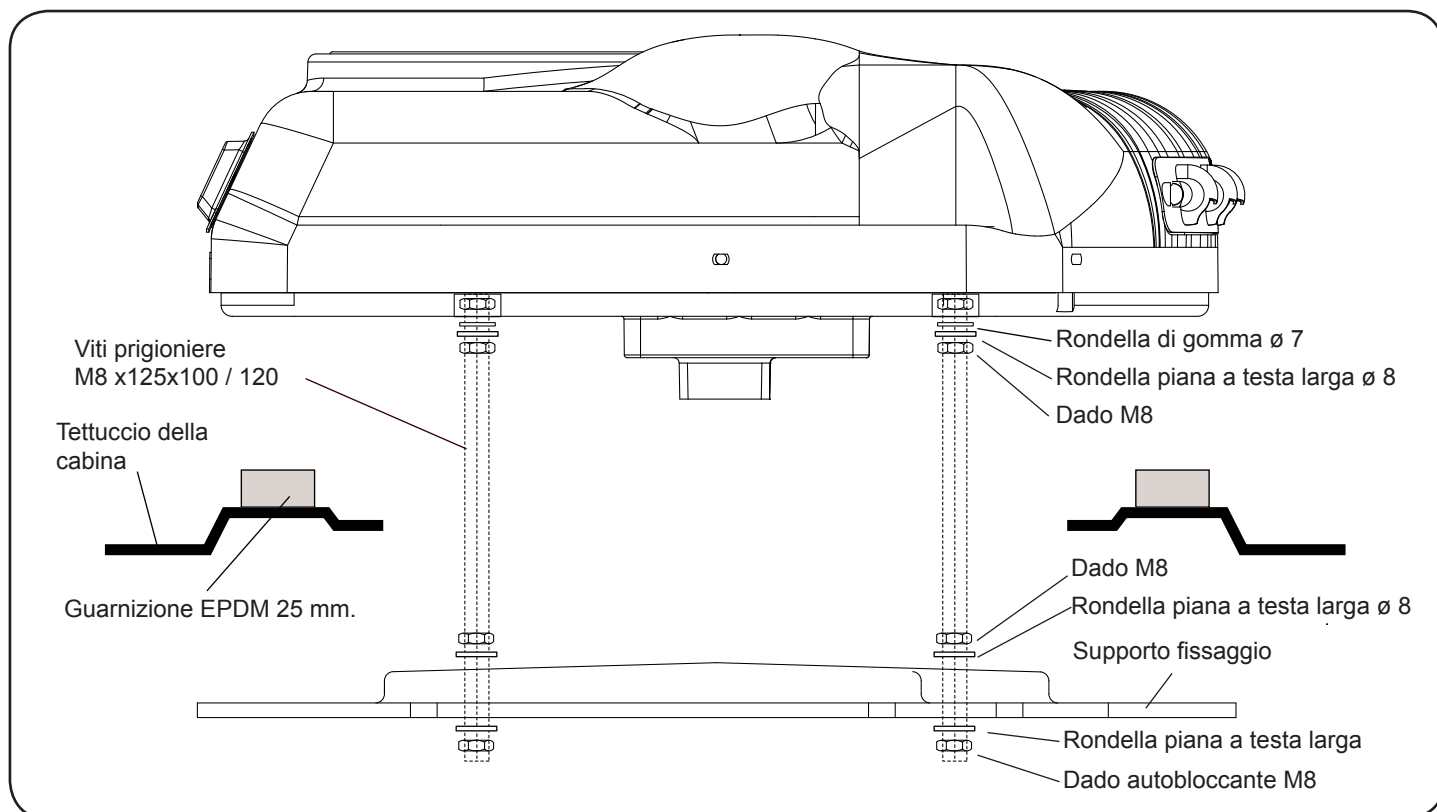

Esploso fino al fissaggio della consolle

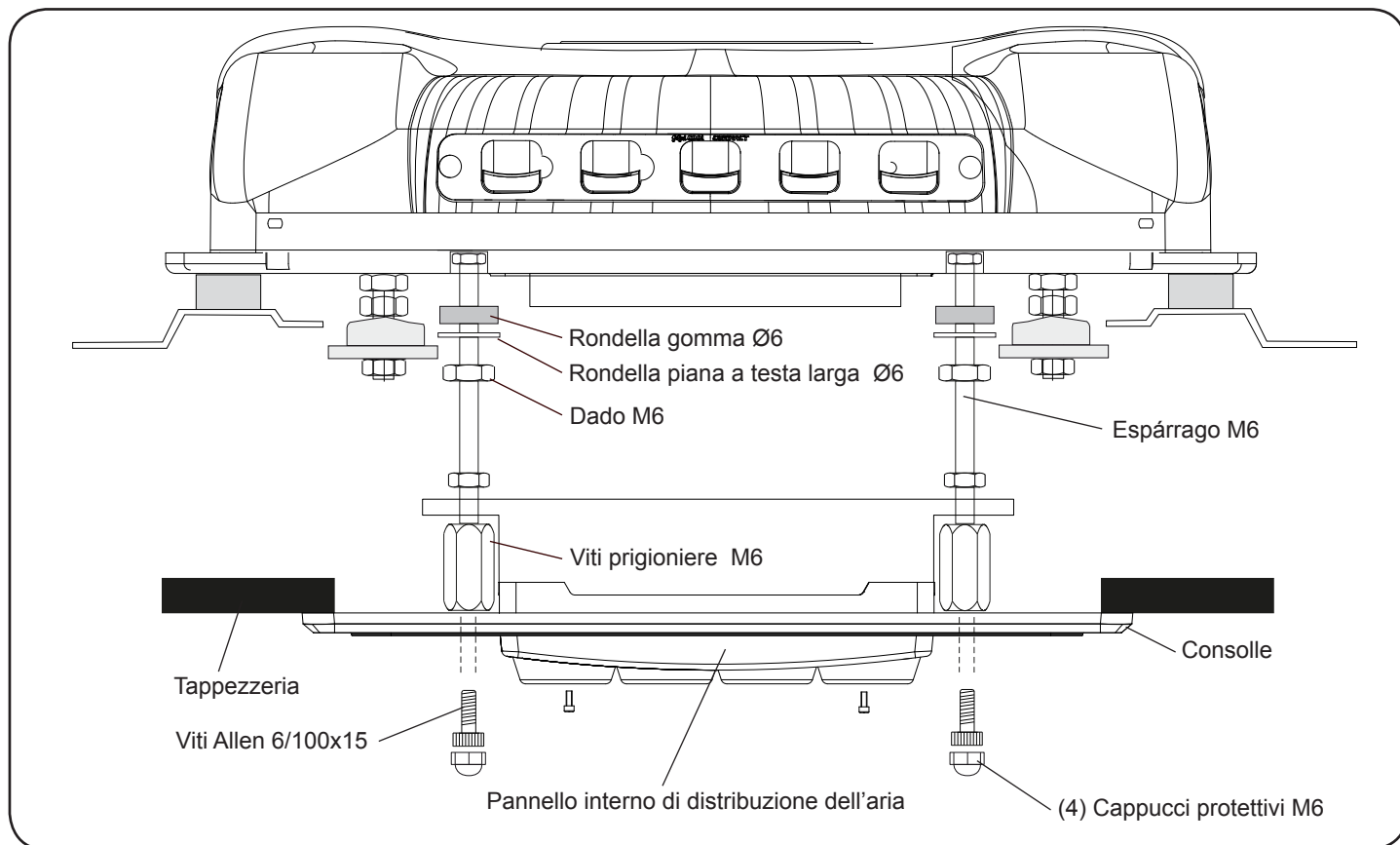

Istruzioni dettagliate Sull'installazione del cablaggio di alimentazione

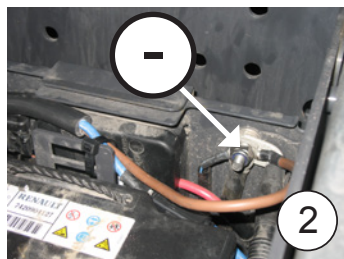
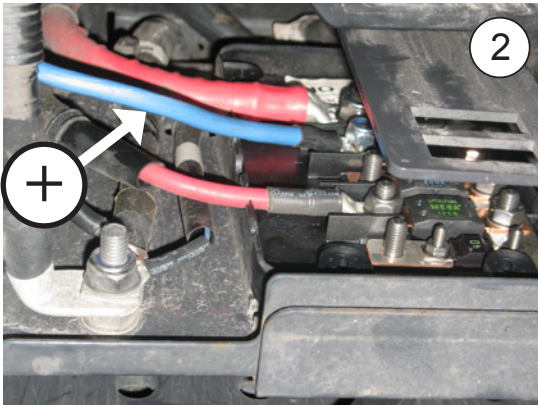

Cableado de alimentación superior

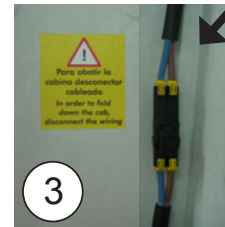

- 1- Collegare il cavo di alimentazione superiore nella parte posteriore dell'impianto e farlo scorrere lungo la parte posteriore della cabina incollando i supporti di plastica e fissandolo con le flange.
- 2- Collegare il cavo di alimentazione inferiore in Scatola di fusibili il + e nel centro di masse quello -facendolo scorrere lungo il passaggio originale dei cablaggi, fissato con le flange, verso la parte posteriore della cabina, per effettuare il collegamento con il cavo di alimentazione superiore.

QUANDO SI COLLEGANO I CABLAGGI, RISPETTARE LA DISTANZA NECESSARIA PER EVITARNE LA ROTTURA CON I MOVIMENTI DELLA CABINA!

NOTA BENE: Dato il complesso sistema di regolazione elettronica dell'impianto, la presa di corrente deve essere effettuata direttamente nei punti indicati della scatola del fusibile.

Fare attenzione a non invertire le polarità effettuando la connessione dell'alimentazione all'impianto, altrimenti il quadro comandi non si accende, l'impianto non funziona e si potrebbero verificare danni irreparabili ai moduli dei compressori.

NOTA BENE: Per la messa in funzione, vedi il Manuale dell'utente.

- 3- Apporre gli adesivi indicanti pericolo sulla giunzione del cablaggio e sul dispositivo di sollevamento della cabina.

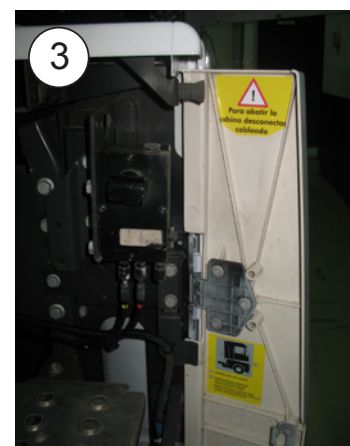

Cablaggio elettrico

AVVISO IMPORTANTE!

Fare attenzione a non invertire le polarità effettuando la connessione dell'alimentazione all'impianto, altrimenti il quadro comandi non si accende, l'impianto non funziona e si potrebbero verificare danni irreparabili ai moduli dei compressori.

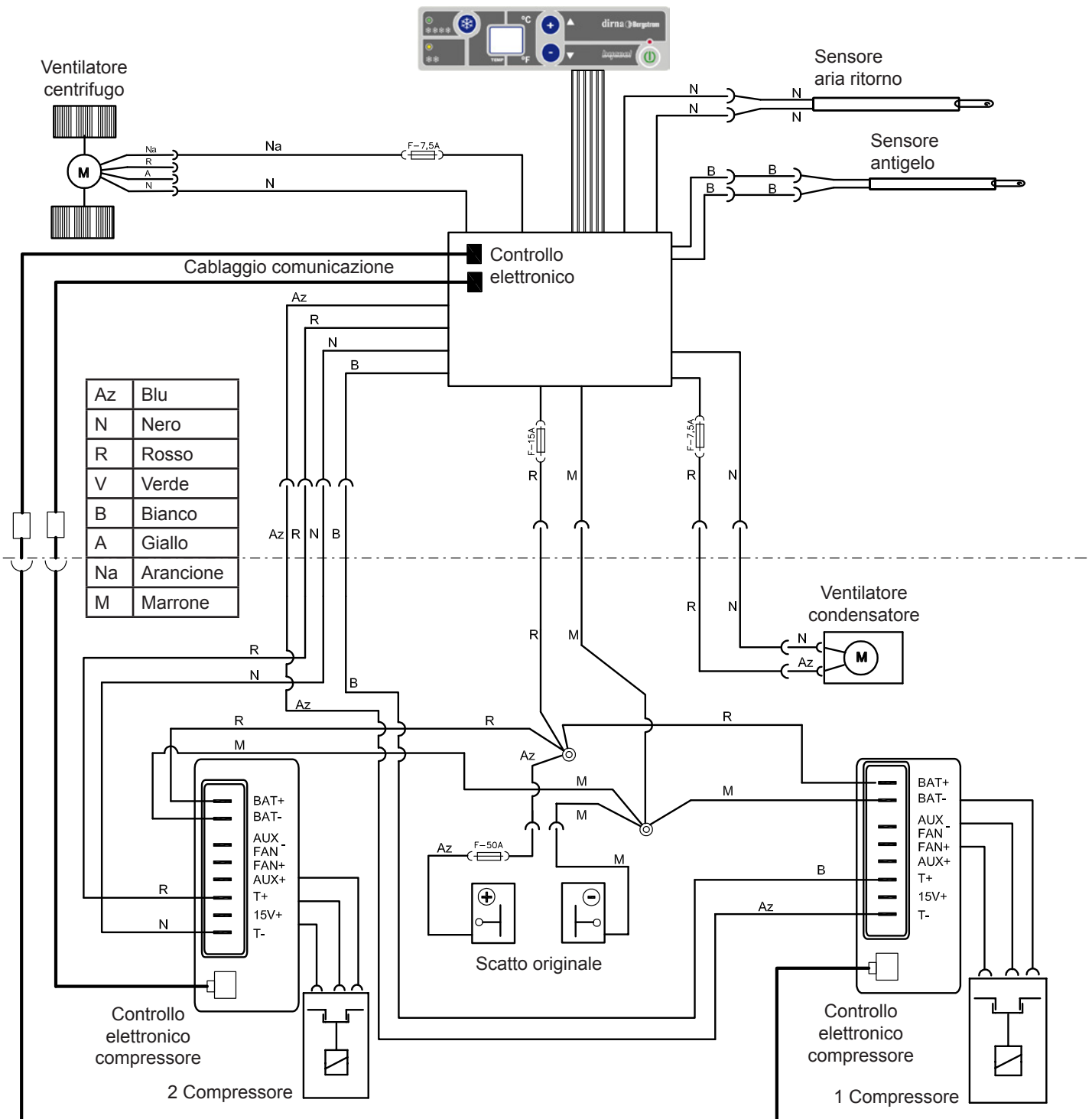

Ed:	28/10/2016
Md:	06/08/2019

b



Francisco Alonso, 6
28806 Alcalá de Henares, Madrid
SPAIN

Contact	Phone	Fax	E-Mail
Sales (Ventas Internacional)	+34 91 8770510	+34 91 8771158	sales@dirna.bergstrominc.com
Comercial Nacional	+34 91 8775841	+34 91 8836321	ventas@dirna.bergstrominc.com
Orders & Deliveries (Logística internacional)	+34 91 8775846	+34 91 8771158	export@dirna.bergstrominc.com
Orders & Deliveries (Logística nacional)	+34 91 8775840	+34 91 8836321	comercial@dirna.bergstrominc.com
Technical Assistance (Internacional)	+49 511 86679681	+49 511 86679710	technicalassistance@dirna.bergstrominc.com
Technical Assistance (Nacional)	+34 91 8775845	+34 91 883 6321	oblanco@dirna.bergstrominc.com

www.dirna.com

	ATENCIÓN:	Dirna Bergstrom se reserva el derecho de efectuar modificaciones en cualquier momento de los datos contenidos en esta publicación, por razones técnicas o comerciales.
	NOTE:	<i>For technical and commercial reasons, Dirna Bergstrom reserves the right to change the data contained in this brochure.</i>
	ATTENTION:	Dirna Bergstrom se réserve le droit d'effectuer à tout moment des modifications des données reprises sur cette publication, pour des raisons techniques ou commerciales.
	HIWEIS:	<i>Dirna Bergstrom behält sich vor, aus technischen oder kaufmännischen Gründen jederzeit Änderungen der Angaben dieser Veröffentlichung vorzunehmen.</i>
	ATTENZIONE:	Dirna Bergstrom si riserva il diritto di effettuare modifiche in qualsiasi momento ai dati contenuti in questa pubblicazione, per motivi tecnici o commerciali.