

bycool!
green line

COMPACT 3.0

RENAULT T High sleeper cab



Instrucciones de Montaje

Mounting Instructions

Instructions de Montage

Montageanweisungen

Istruzioni di Montaggio

ES Spanish

EN English

FR French

GE German

IT Italian

Recomendaciones Para el montaje

- Antes de iniciar el montaje leer las instrucciones y seguirlas durante el proceso de instalación.
- Usar las herramientas adecuadas para cada operación.

Electricidad

- Desconectar la llave de contacto.
- Desconectar la batería antes de empezar el montaje.
- Asegurar el conexionado de los componentes eléctricos, verificando su correcto encaje.

Atención

Si durante el montaje el equipo se inclina ó se abate la cabina con el equipo montado, se deberá esperar un mínimo de 60 minutos, desde que el equipo quede horizontal, antes de ponerlo en marcha.

Atención

Al instalar el equipo de aire acondicionado en el techo se debe proteger la parte superior de la cabina con un paño ó manta protectora para evitar posibles arañazos. Al instalar **Compact** en el techo hay que tener en cuenta que, normalmente, las cabinas que vienen provistas de escotilla, tienen una estructura suficiente para soportar el peso del equipo. Sin embargo, cuando no ocurra así y sea necesario realizar corte en el techo ó incluso si en el caso de llevar escotilla el material no es lo suficientemente resistente (caso de techo de fibra, plástico, etc...) es el instalador el que debe decidir, **bajo su responsabilidad**, sobre la necesidad de reforzar el techo para evitar posibles deformaciones, roturas, entradas de agua, etc... habilitando los medios para que esto no ocurra.

Herramientas

Juego de Llaves Torx

Juego de Llaves Allen

Llave fija 10,13, 14

Tijeras

Flexómetro

Documentación incluida

Instrucciones de montaje 1001261106

Listado de recambios 220RE00214

Simbología



Frágil



Atención corte!



Riesgo eléctrico

Advertencias



El personal instalador debe poseer una formación suficiente en Aire Acondicionado de vehículos.



dirnaBergstrom, s.l. queda exenta de responsabilidad si se producen averías que procedan de una inadecuada manipulación ó instalación del equipo, ó por modificaciones y sustituciones efectuadas sin nuestra expresa autorización por escrito.



Equipo precargado con gas refrigerante. (No manipular el circuito de gas refrigerante).



Véase **procedimiento de garantía** del producto incluido en **Diagnosis de Averías**.



Véase **Manual de Usuario** del equipo para el correcto funcionamiento del mando a distancia y del panel de control.



Al finalizar la instalación se debe entregar al usuario: **Manual del Usuario, Garantía y Diagnosis de averías.**

 Antes de empezar con el montaje, montar rejilla entrada aire delantera.



1 Desmontar consola original, tirando del extremo de las luces para acceder a los tornillos de fijación.



2

Limpiar el área de la escotilla de la posible suciedad y grasa adherida antes de pegar la junta EPDM. Pegar la junta EPDM 30x25 por el resalte del contorno del hueco de la escotilla.



3

COMO CORTAR LA JUNTA EPDM PARA EVITAR FILTRACIÓN DE AGUA EN LA CABINA

- A- Pegar la junta, manteniendo 100 mm de papel protector por cada lado.
- B- Quitar los dos piezas de papel.
- C- Pegue presionado ambos finales.

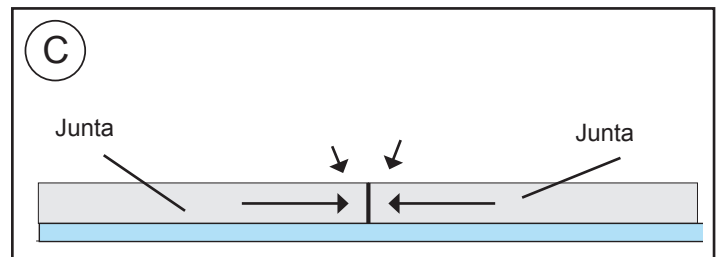
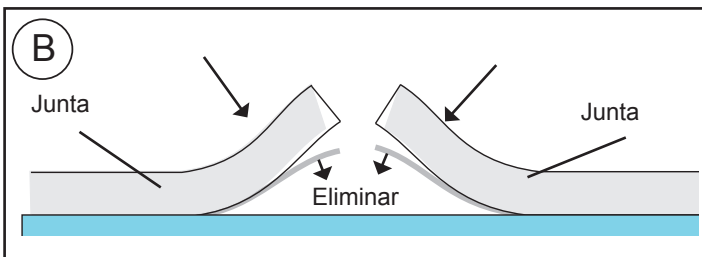
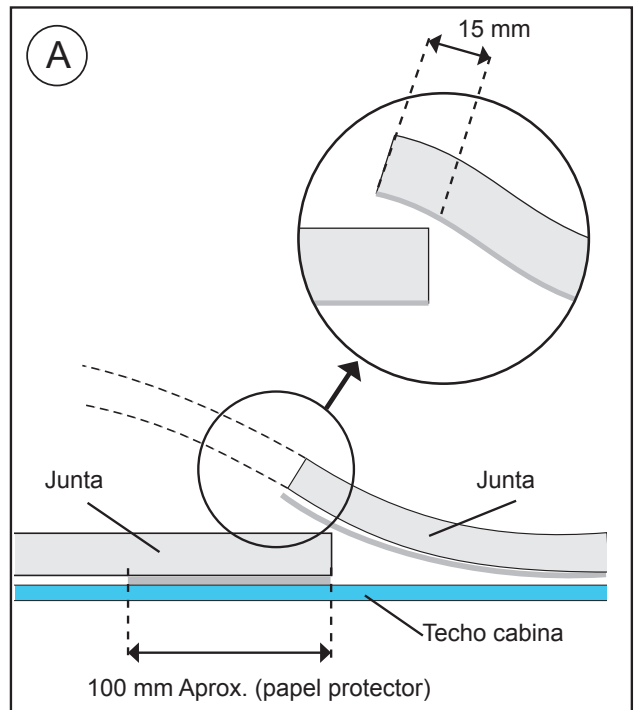

4

EXTERIOR CABINA: Posicionar el equipo en el hueco de la escotilla.

ATENCIÓN: Al colocar el equipo encima del hueco escotilla, revisar que las salidas de desagüe no queden obstruidas por la junta EPDM.

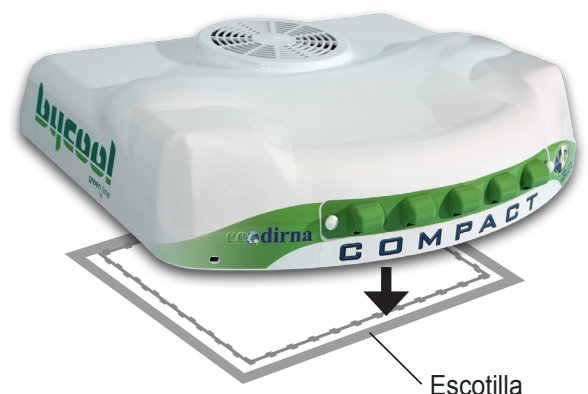

5 Colocar acoplamiento canalizador quedando la parte más blanda en la base del equipo.



6 Montar arandelas en separadores como se indica.

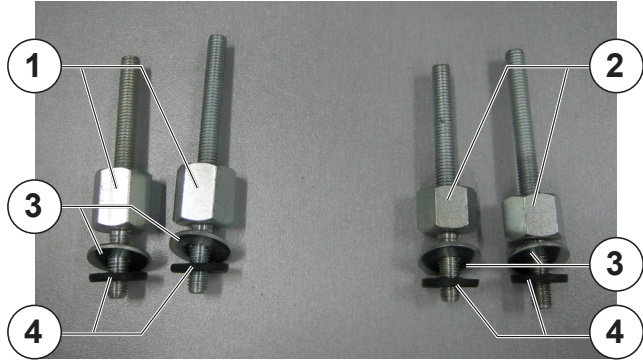

- 1 Separador 22 mm
- 2 Separador 17 mm
- 3 Arandela plana Ø 8 ala ancha
- 4 Arandela goma Ø 20 x Ø 7 x 3 mm

7 Montar arandelas en separadores como se indica.

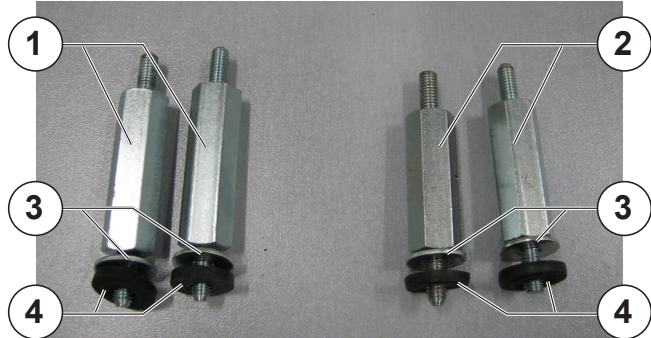

- 1 Separador 50 mm
- 2 Separador 43 mm
- 3 Arandela plana Ø 8 ala ancha
- 4 Arandela goma Ø 18 x Ø 6 x 3 mm

8 Montar y apretar separadores teniendo en cuenta la posición según sus medidas.



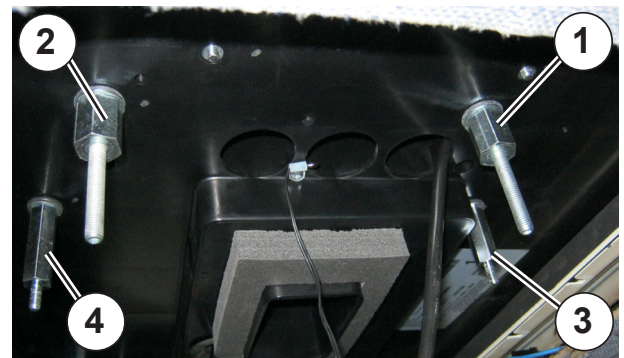

- 1 Separador M8 22 mm
- 2 Separador M8 17 mm
- 3 Separador M8 50 mm
- 4 Separador M8 43 mm

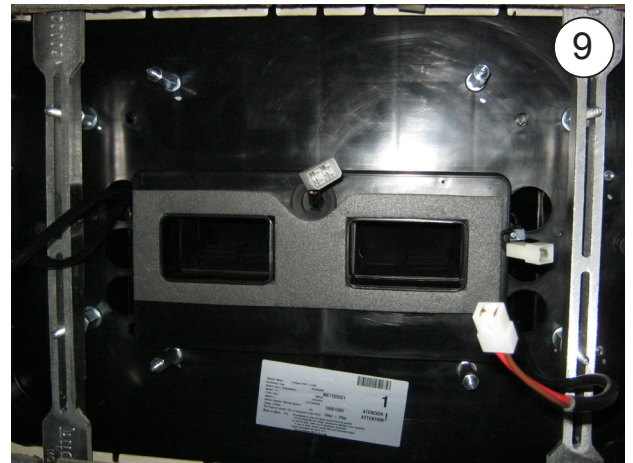
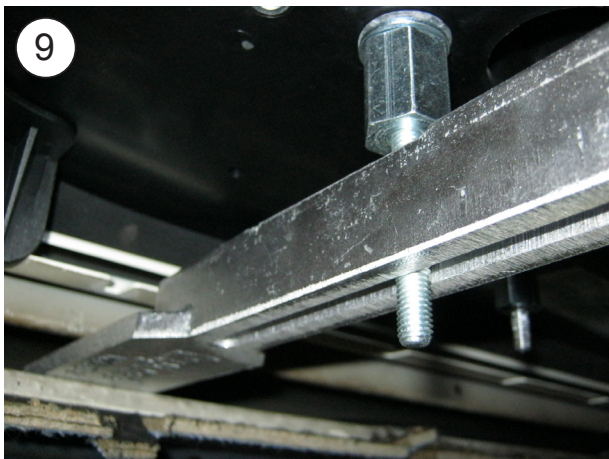

- 1 Separador M8 22 mm
- 2 Separador M8 17 mm
- 3 Separador M8 50 mm
- 4 Separador M8 43 mm

9 Introducir soportes en espárragos M8 por debajo del tapizado. Poner (4) arandelas planas Ø8 ala ancha y (4) tuercas M8 autoblocantes sin llegar a apretar totalmente.



 **PRECAUCIÓN:** Tener cuidado de no pillar el cableado de la escotilla.



10 Entre la base y el panel interior de distribución de aire, conectar (2) cajas de dos vías de sensor antihielo (cables blancos) y sensor aire de retorno (cables negros), caja de 4 vías del soplador, (2) cables de comunicación y caja de 8 vías de cableado a conexión con control electrónico.

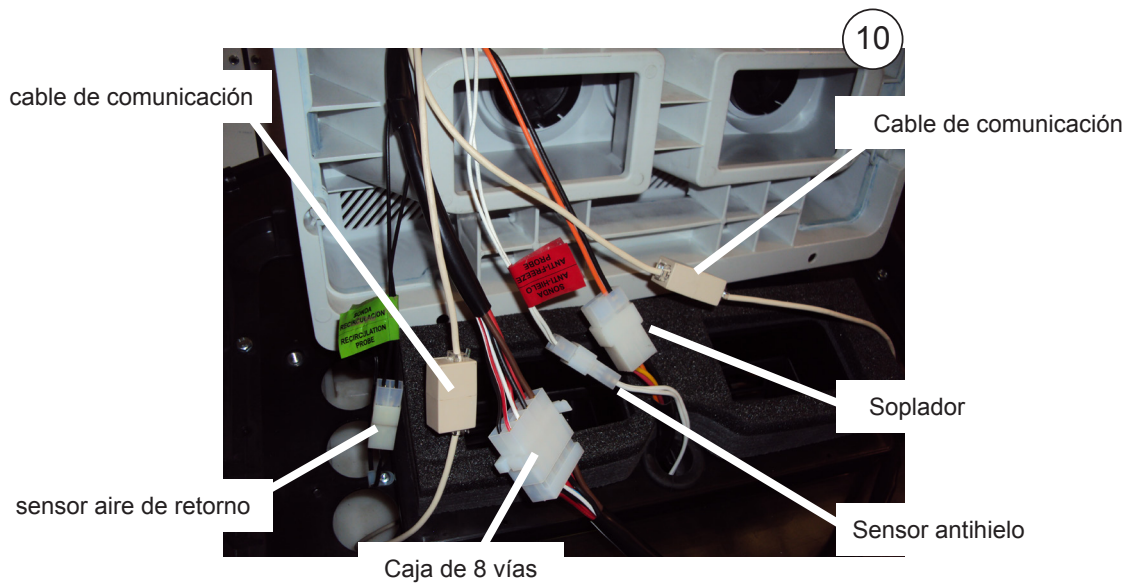

11 Montar panel interior de distribución de aire con (4) hexágonos teniendo en cuenta su posición según medidas.

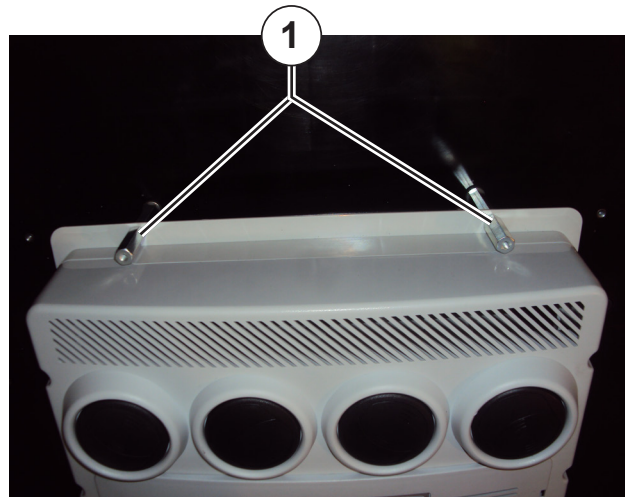
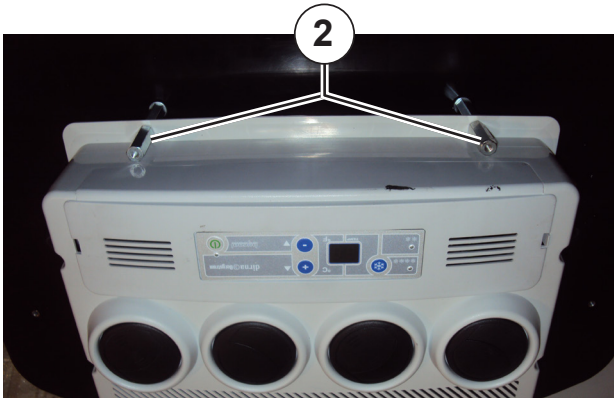

1 Separador 50 mm en parte delantera
2 Separador 43 mm en parte trasera

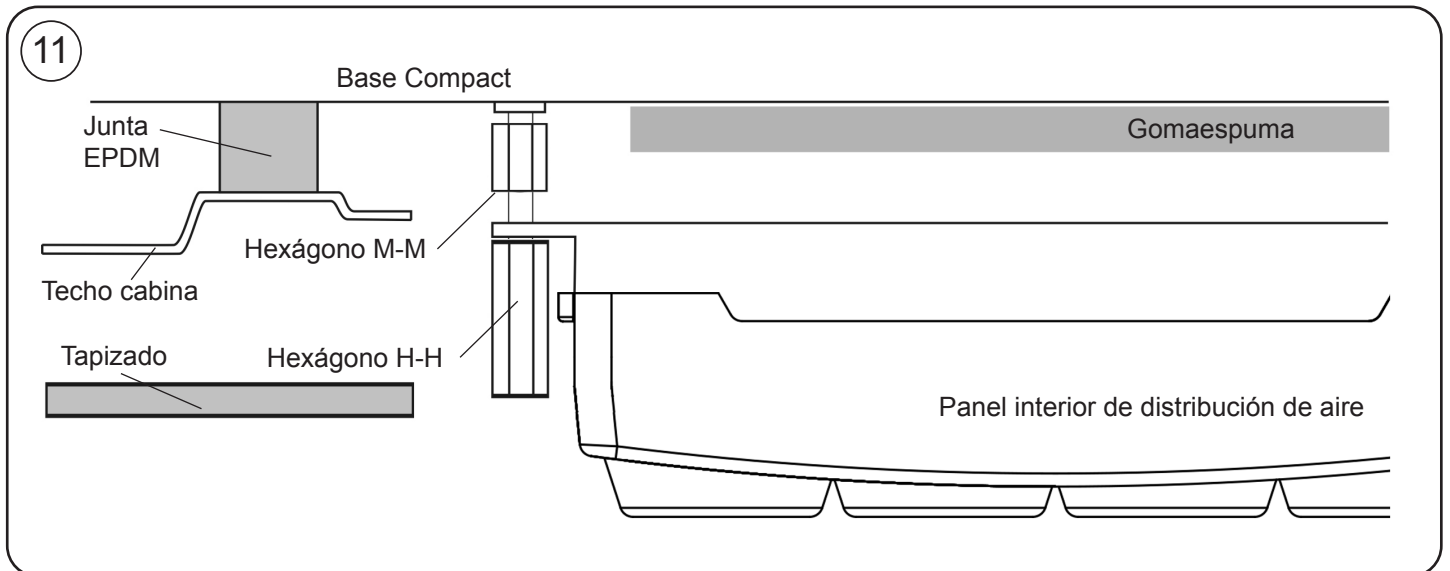

12 Montar consola apuntando (4) tornillos M6x16 y centrar equipo hasta hacer coincidir la consola en la ubicación del tapizado donde estaba montada la consola original.



13

Una vez centrado, desmontar consola y apretar los soportes hasta que hagan tope con los hexágonos.

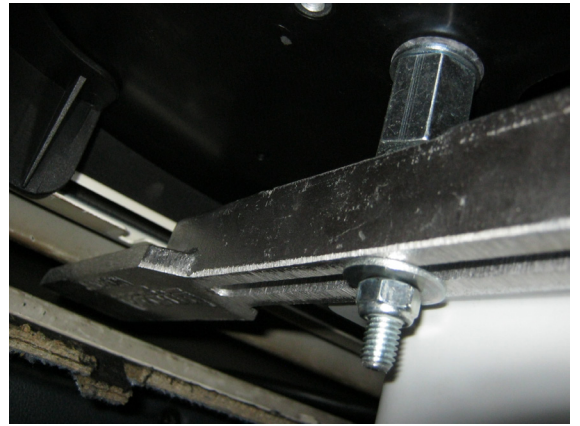

14

Verificar por el exterior que los desagües del equipo están libres y no interfieren con la junta EPDM del equipo.

15

Volver a montar la consola con tornillos M6x16 apretando hasta hacer tope con los hexágonos.



16

Conectar las luces y encajarlas presionando en la consola.



VISTA EXPLOSIONADA HASTA FIJACIÓN DE LOS SOPORTES

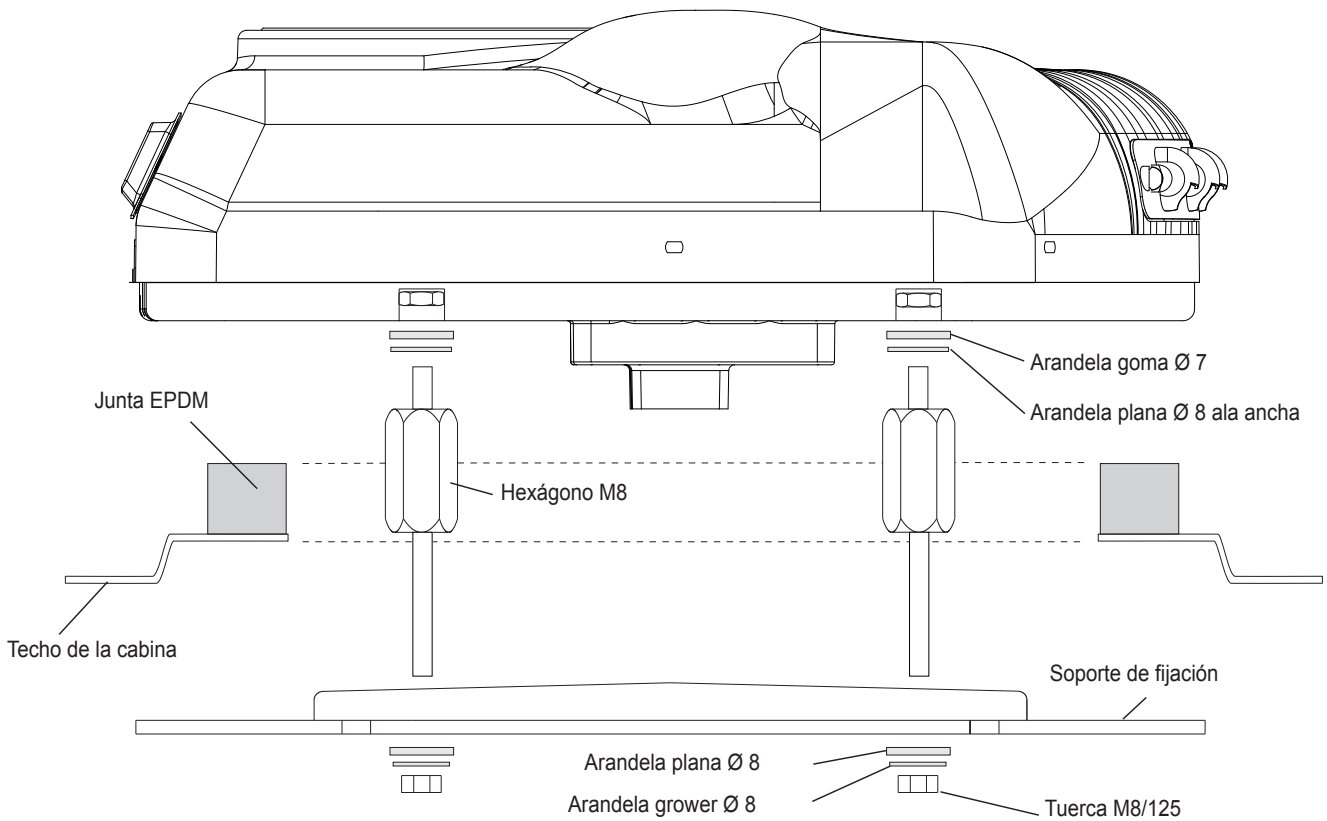

VISTA EXPLOSIONADA HASTA LA FIJACIÓN DE LAS CONSOLAS

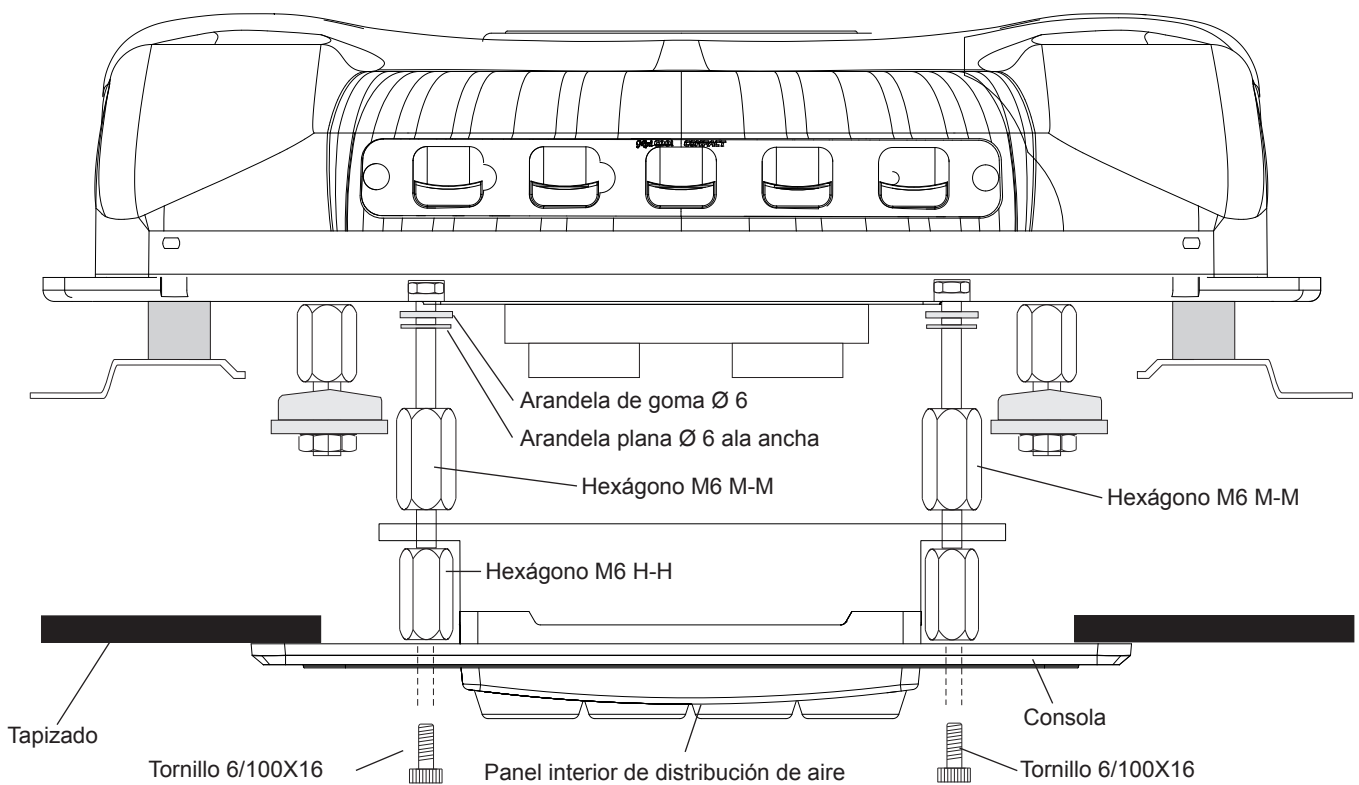

17

Sujetar cableado con soportes con adhesivo y bridas a cabina, soporte spoiler lateral y cableado original.

ATENCIÓN: limpiar bien la zona antes de pegar los soportes con adhesivo.

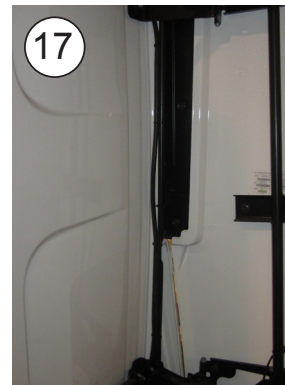

18

Conectar cableado de alimentación inferior con el superior dejando la distancia adecuada para evitar su rotura por los movimientos de la cabina.

MUY IMPORTANTE: Colocar adhesivos de peligro en unión del cableado y en dispositivo de elevación cabina por si se abate la cabina tener en cuenta la desconexión de las clemas del cableado.

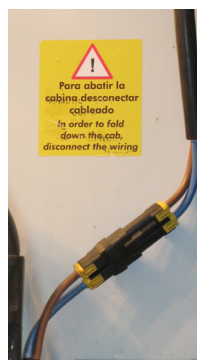
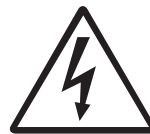

19 Desmontar protector motor (*) y pasar cableado hacia las baterías por dentro del chasis fijándolo con los cableados originales.

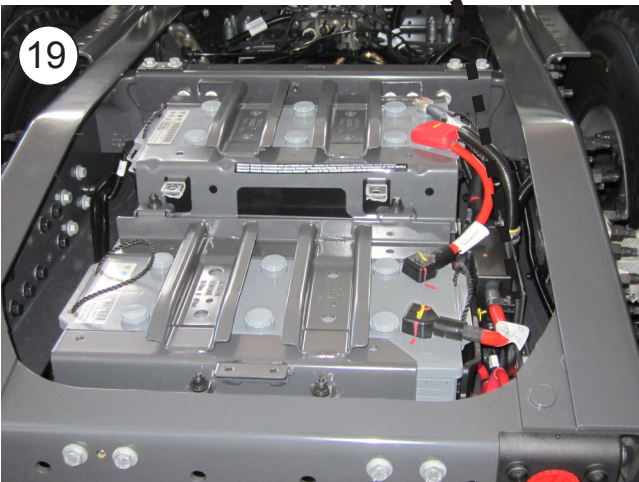
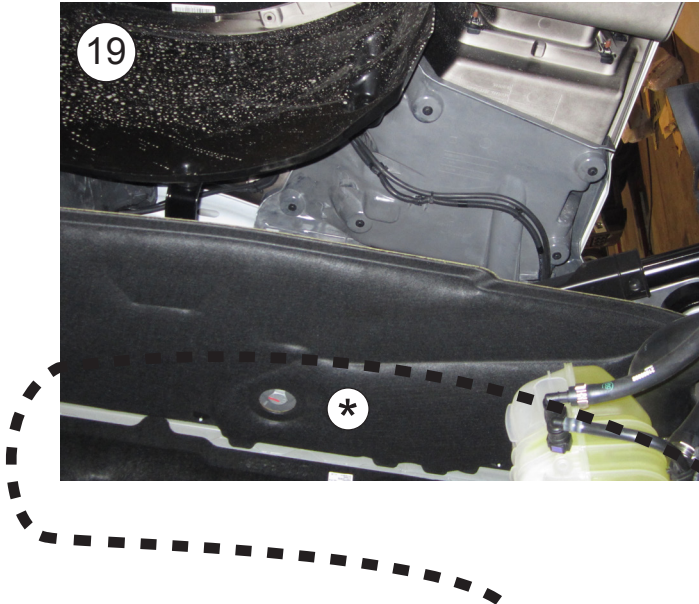

20 Desmontar caja fusibles (*) y conectar (+) a la misma y (-) a toma de masas original.

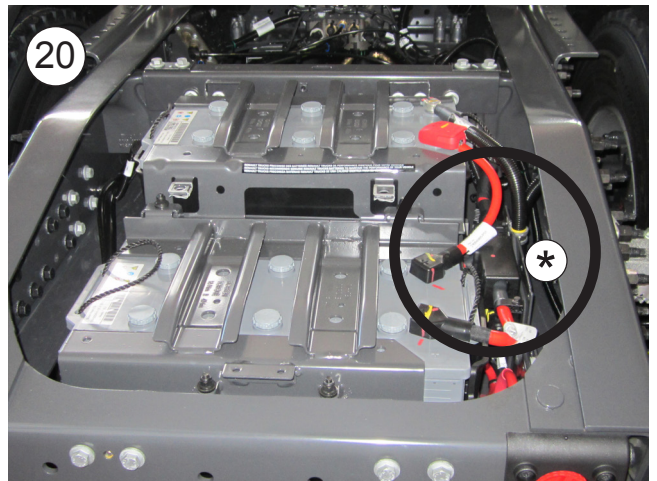

Esquema eléctrico

¡AVISO IMPORTANTE!

Precaución de no invertir las polaridades al conectar la alimentación en el equipo. Si esto sucediera la placa no se encenderá, el equipo no funcionará y se producirán daños irreparables en los módulos de los compresores.

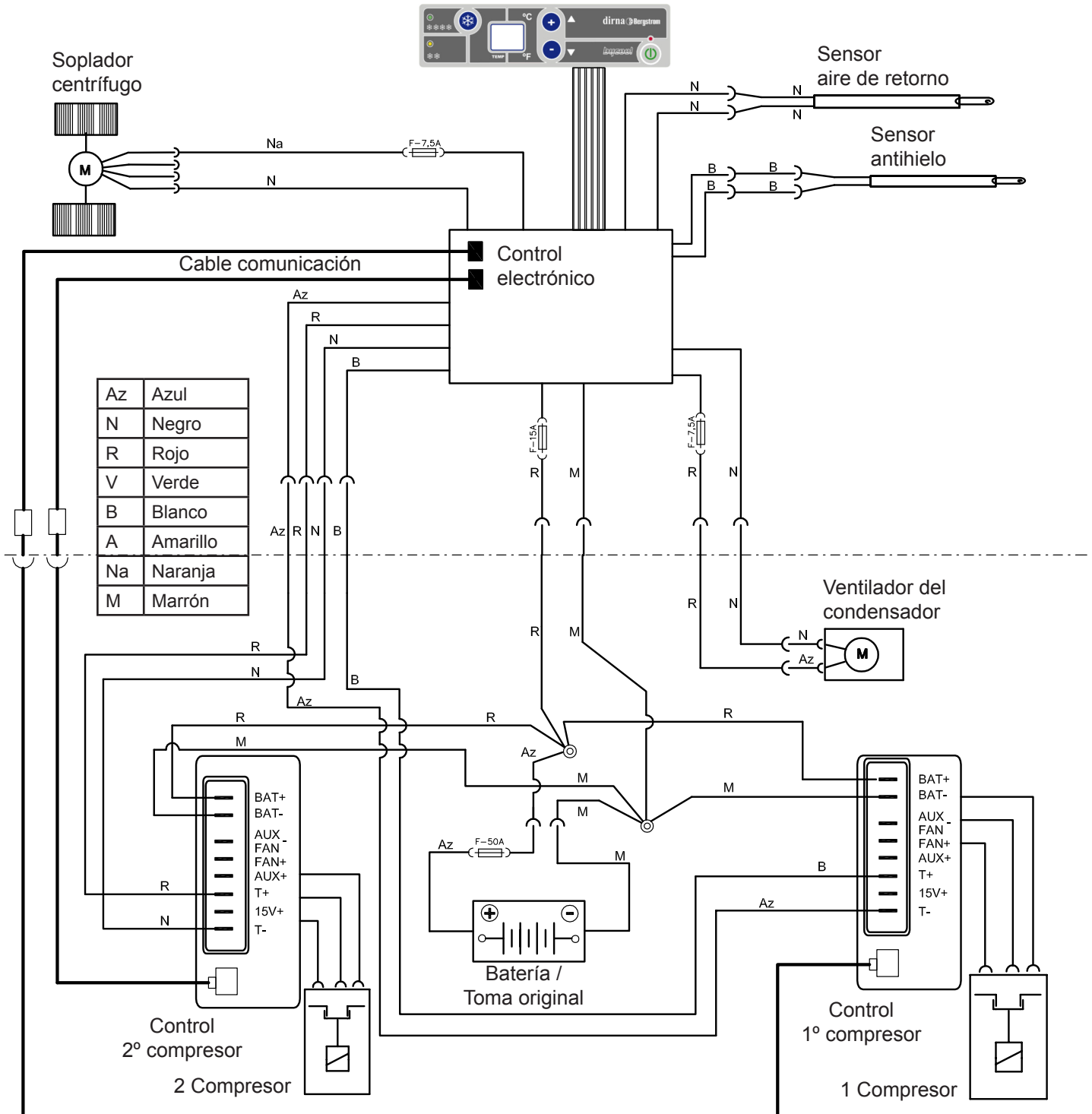

Assembly Recommendations

- Before starting assembly, please read instructions and follow them during installation process.
- Use the adequate tools for each operation.

Electricity

- Disconnect ignition key.
- Disconnect battery before starting assembly.
- Make sure electric components are securely connected, checking their correct fitting.

Warning

If the unit slants during assembly, wait for at least 60 minutes with the unit in horizontal position before starting it up.

Warning

When installing air conditioning equipment on roof, the upper cabin part must be protected with a cloth or a protective blanket to avoid possible scratches. When installing **Compact** on roof, take into account that, normally, cabins equipped with a hatch have a strong enough structure to hold equipment weight. However, if it is not the case and it is necessary to carry out a cut in the roof or, although it has a hatch, the material is not resistant enough (*if roof is made of fibre, plastic, etc...*), it is the installer who will have to decide, under his responsibility, if it is necessary to reinforce the roof to avoid possible deformations, breaks, water entries, etc., habitating the means required to stop it from occurring.

Tools

Torx wrenches set
 Allen wrenches set
 Open-jawed spanner 10, 13, 14
 Scissors
 Flexo-meter

Documentation included

Mounting instructions	1001261106
Parts list	220RE00214

Symbology



Fragile









Beware of cuts!



Electrical hazard

Warnings

-  The installing personnel must have a sufficient training in vehicles air conditioning.
-  **dirna Bergstrom, s.l.** shall not be responsible for breakdowns or damages coming from an inadequate handling or installation of the equipment or from modifications and substitutions carried out without our express and written authorisation.
-  **Equipment pre-charged with refrigerating gas. (Do not handle refrigerating gas circuit).**
-  Please see product **warranty procedure** included in **Troubleshooting**.
-  Please see equipment **User's Guide** for its correct functioning of the remote control and control panel.
-  Once installation is finished, the following documents must be handed over to the user: **User's Guide, Warranty and Troubleshooting**.

 Mount the front air input grille before starting assembly.



1 Take down the original console, pulling on the end of the lights to access the fastening screws.



2

Clean any dirt and grease from the hatch area before attaching the EPDM seal. Attach the 30x25 EPDM seal around the rim of the hatch gap.



3

HOW TO CUT EPDM GASKET TO AVOID WATER FILTRATION INTO THE CABIN

- A- Glue gasket, keeping 100 mm of protection paper at each side.
- B- Remove the two pieces of paper.
- C- Glue by pressing both ends.

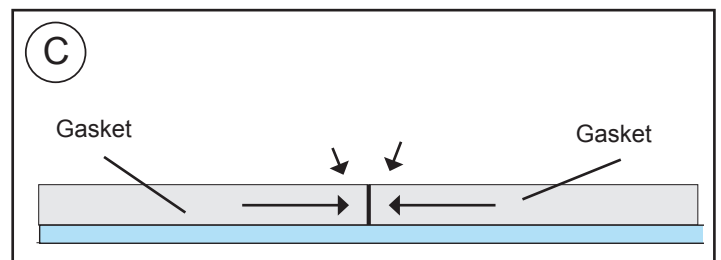
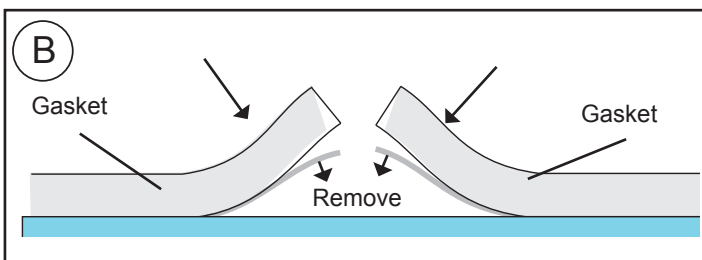
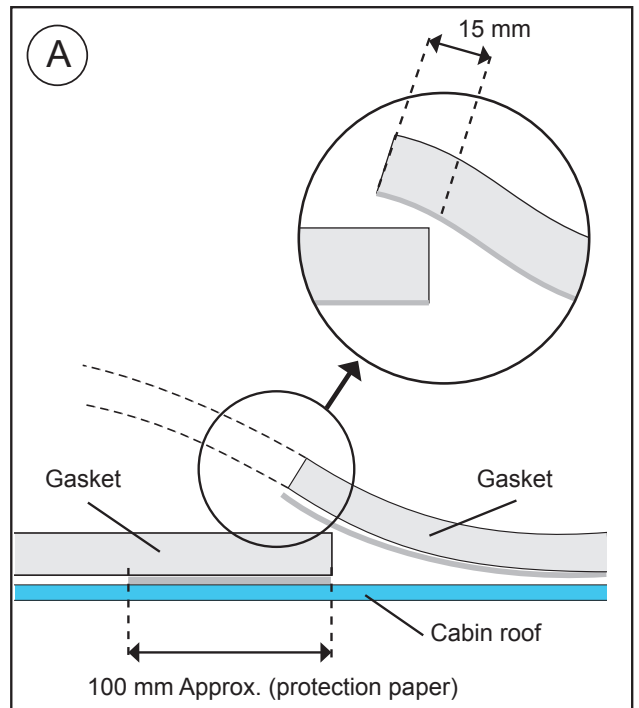

4

CABIN EXTERIOR: Position the unit in the hatch gap.

CAUTION: When positioning the unit above the hatch gap, check that the wastewater run-offs are not blocked by the EPDM seal.

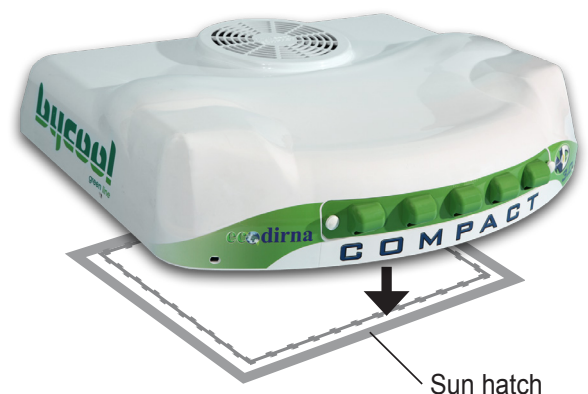

5 Position air duct top side, ensuring the softest part is placed in the base of the unit.



6 Mount washers in the separators as shown.

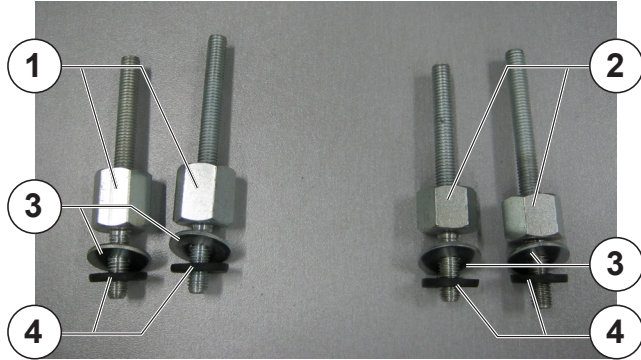

- 1 22 mm separator
- 2 17 mm separator
- 3 Ø8 Flat wide-rimmed washer
- 4 Ø20 x Ø7 x 3 mm rubber washer

7 Mount washers in the separators as shown.

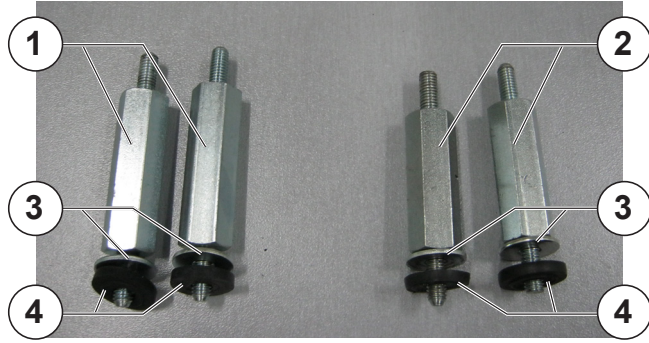

- 1 50 mm separator
- 2 43 mm separator
- 3 Ø8 Flat wide-rimmed washer
- 4 Ø18 x Ø6 x 3 mm rubber washer

8 Mount and tighten the separators taking into account the position in accordance with the measurements.

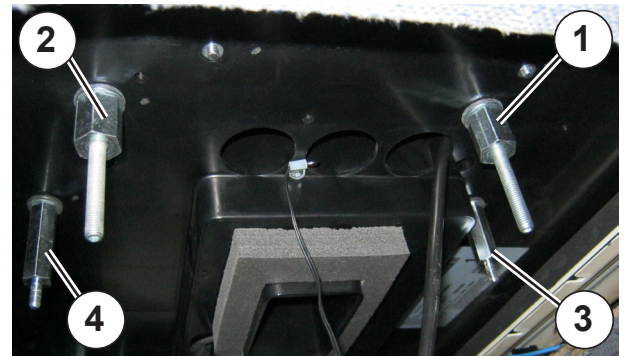

- 1 22 mm M8 Separator
- 2 17 mm M8 Separator
- 3 50 mm M8 Separator
- 4 43 mm M8 Separator

- 1 22 mm M8 Separator
- 2 17 mm M8 Separator
- 3 50 mm M8 Separator
- 4 43 mm M8 Separator

9 Introduce the mounts on M8 studs underneath the upholstery. Position (4) Ø8 wide-rimmed flat washers and (4) M8 self-locking nuts without tightening completely.

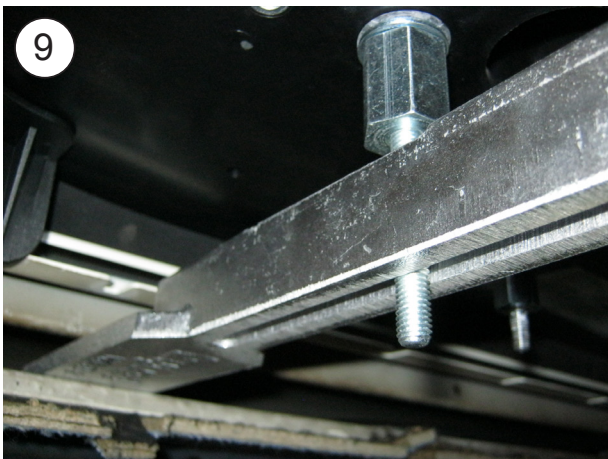



CAUTION: Take care not to trap the hatch cabling.



10

Between the base and the interior air distribution panel, connect (2) two-way boxes of the anti-freeze sensor (white cables) and the return air sensor (black cables), 4-way box of the blower, (2) communication cables and 8-way box of the electronic control connection cables.

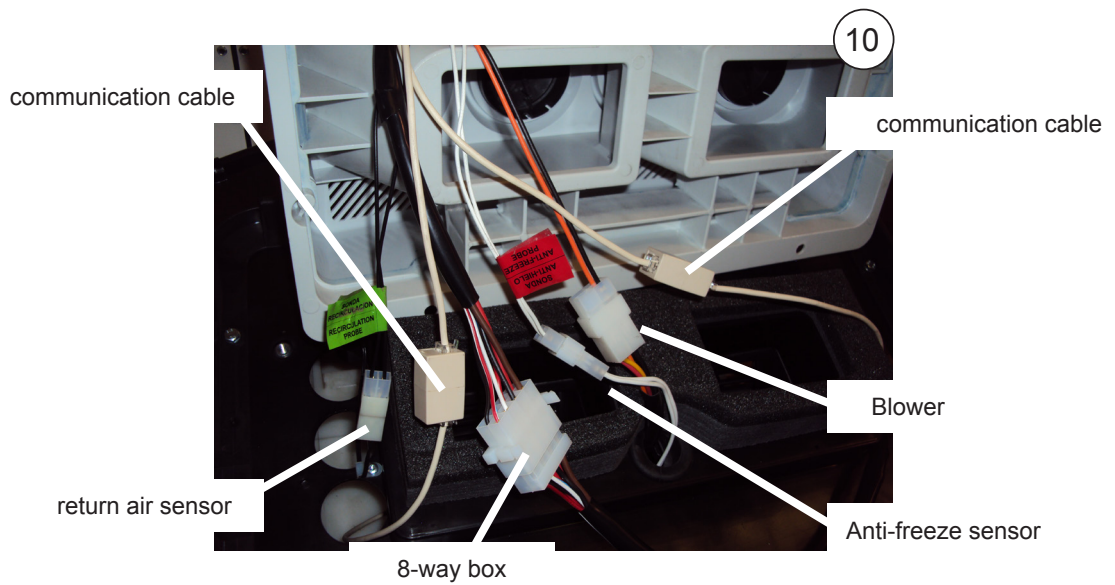

11 Mount the interior air distribution panel with (4) hexagons, taking into account the position in accordance with the measurements.

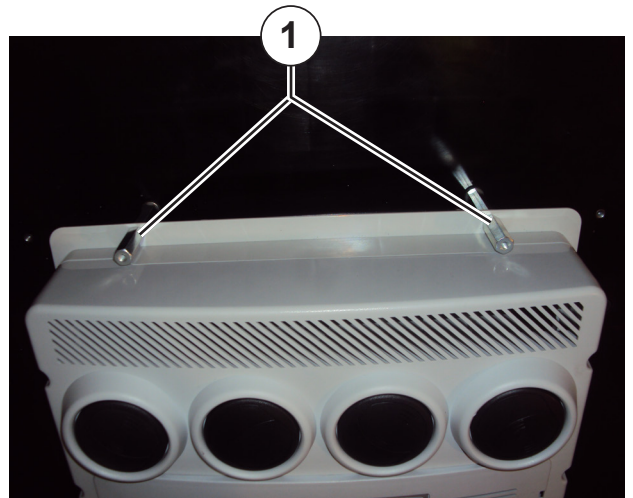
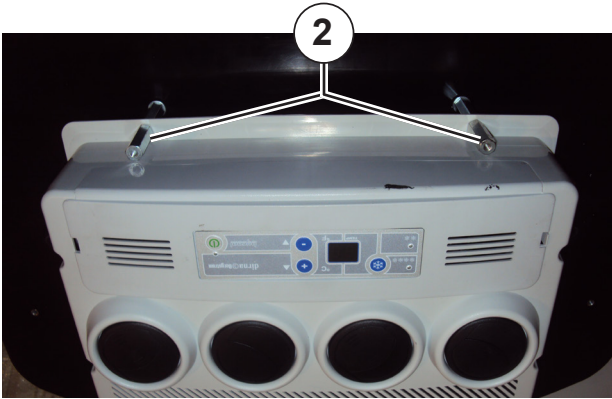

1- 50 mm separator in the front section
2- 43 mm separator in the rear section

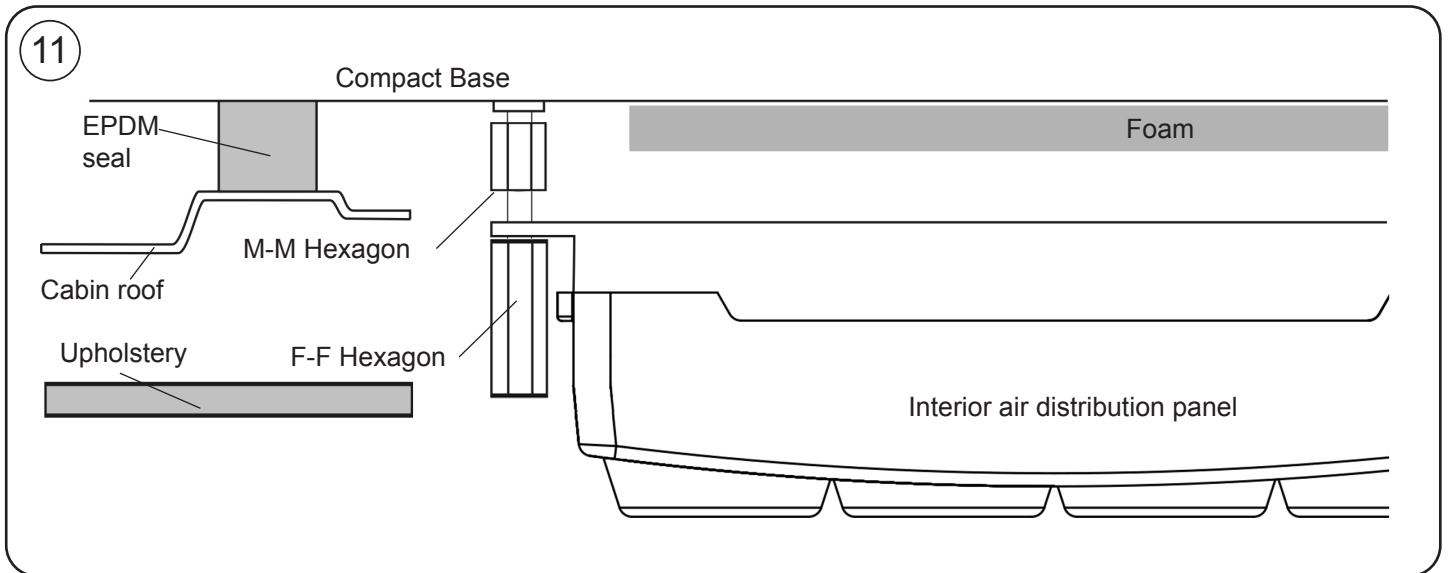

12 Mount the console using (4) M6x16 screws and align the unit until the console coincides in the part of the upholstery where the original console was mounted.



13 Once aligned, take down the console and tighten the mounts until they come up against the hexagons.

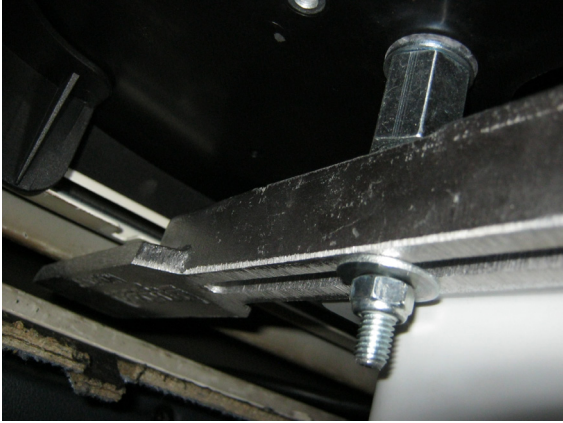

14 Check on the outside that the unit's run-offs are free and do not interfere with the EPDM seal.

15 Return the console using the M6x16 screws, tightening until it comes up against the hexagons.



16

Connect the lights and fit them by pressing on the console.



EXPLODED SIDE VIEW TO SUPPORTS FASTENING

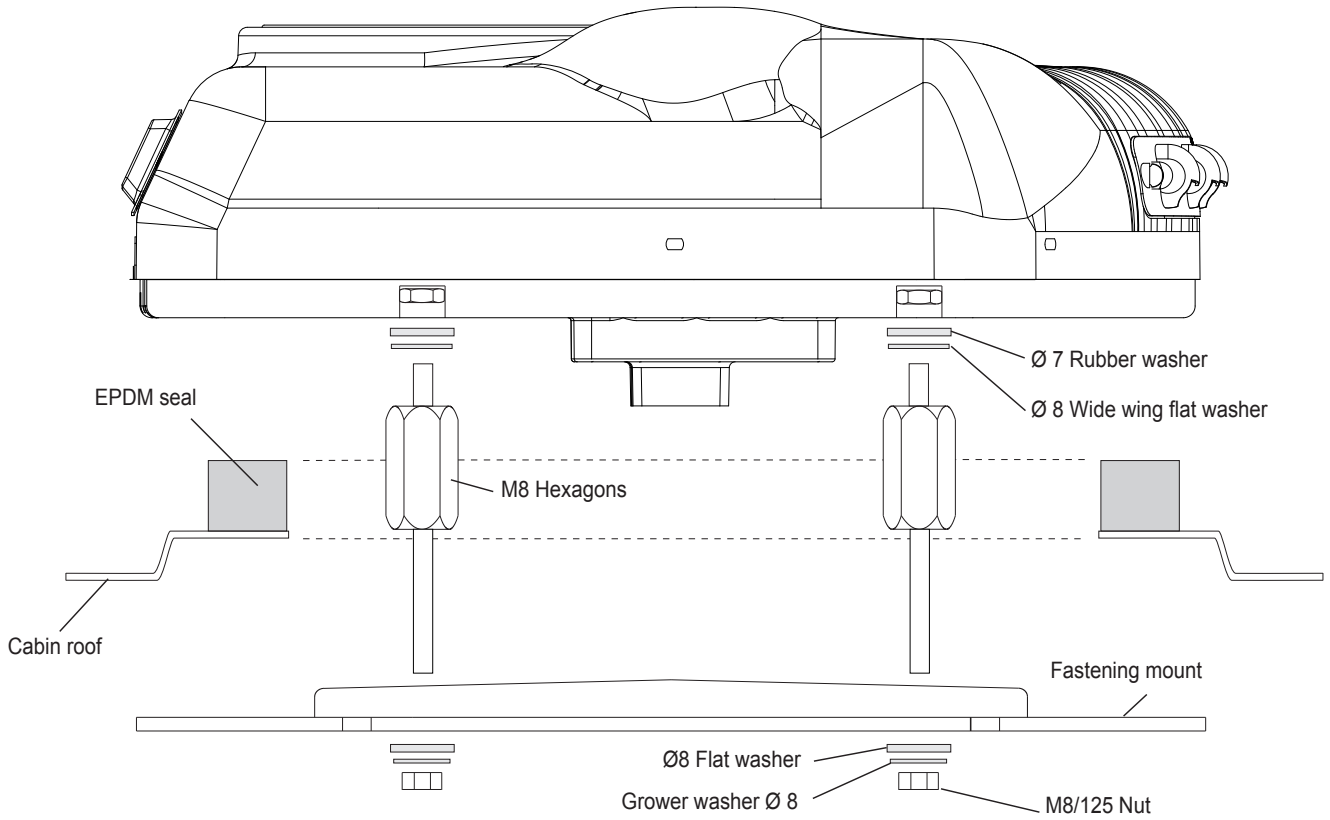

EXPLODED REAR VIEW TO CONSOLES FASTENING

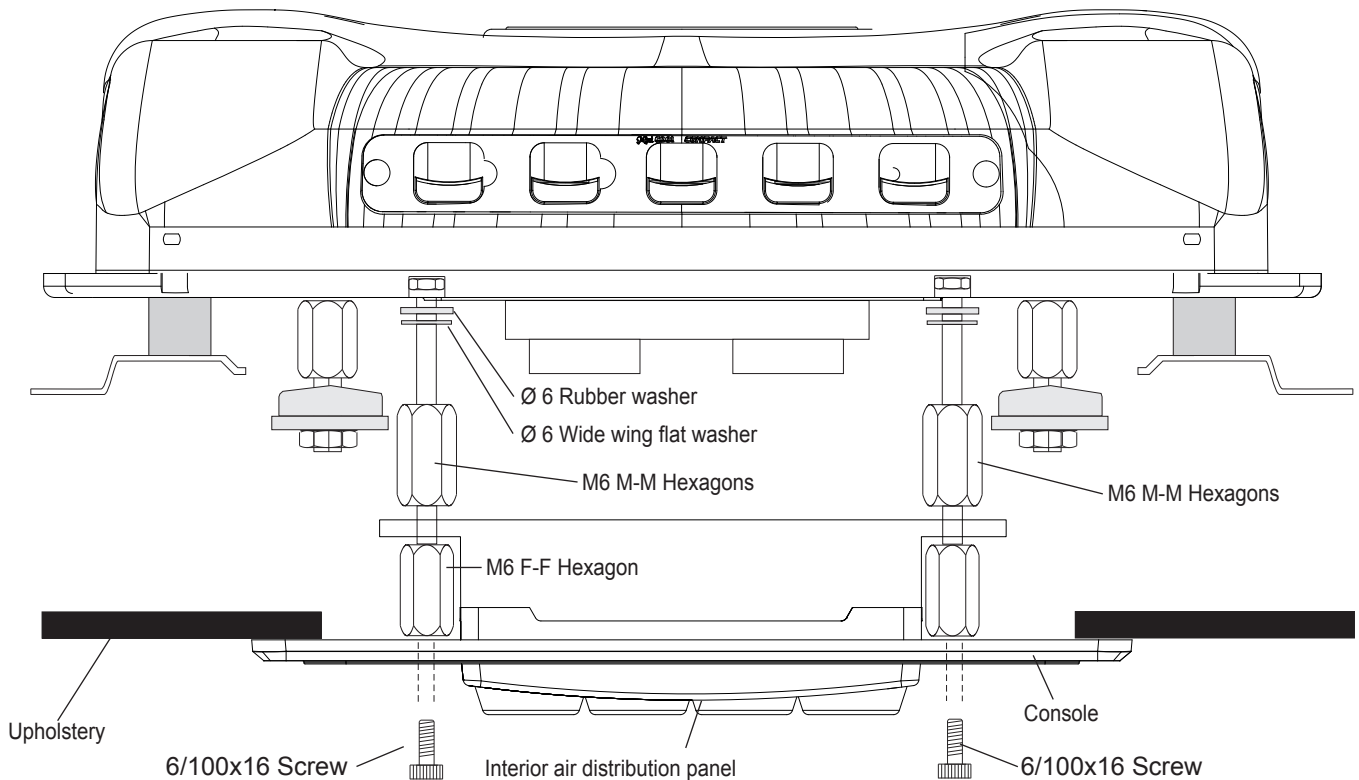

17 Secure the cable with mounts with stickers and flanges to the cabin, side spoiler mount and original cable.

CAUTION: clean the area thoroughly before attaching the mounts with sticker.

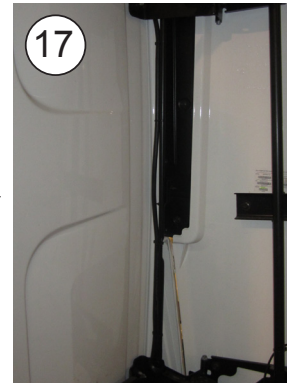

18 Connect the bottom power cable to the top cable, leaving sufficient distance as to avoid breakage when the cabin moves.

VERY IMPORTANT: Place danger stickers at the cable joint and in the cabin lifting device in case the cabin tilts without disconnecting the cable terminals.

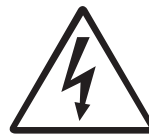

19 Take down the engine protector (*) and pass the cable towards the batteries inside the chassis, securing with the original cable.

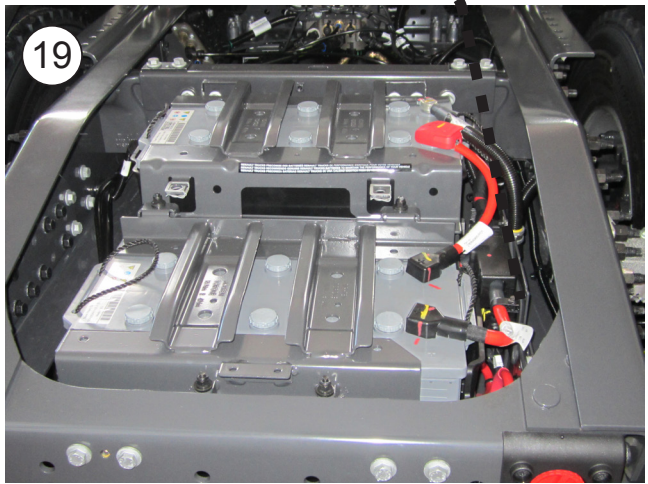
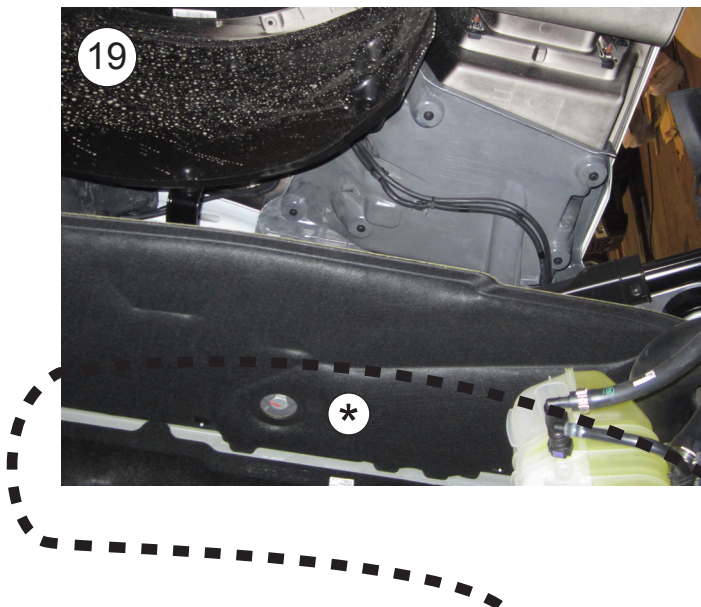

22 Take down the fuse box (*) and connect (+) to it and (-) to the original earth connection.

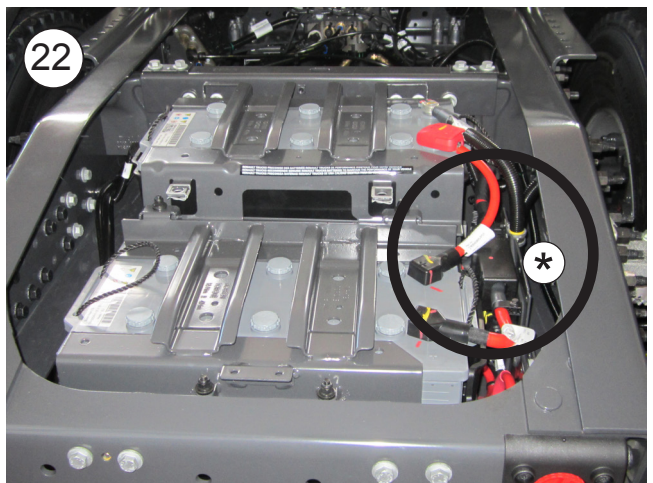

Wiring diagram

IMPORTANT WARNING!

Take care not to invert polarities when connecting the unit to the power supply. If this were to happen, the unit will not work and irreparable damage will be caused to the compressor modules.

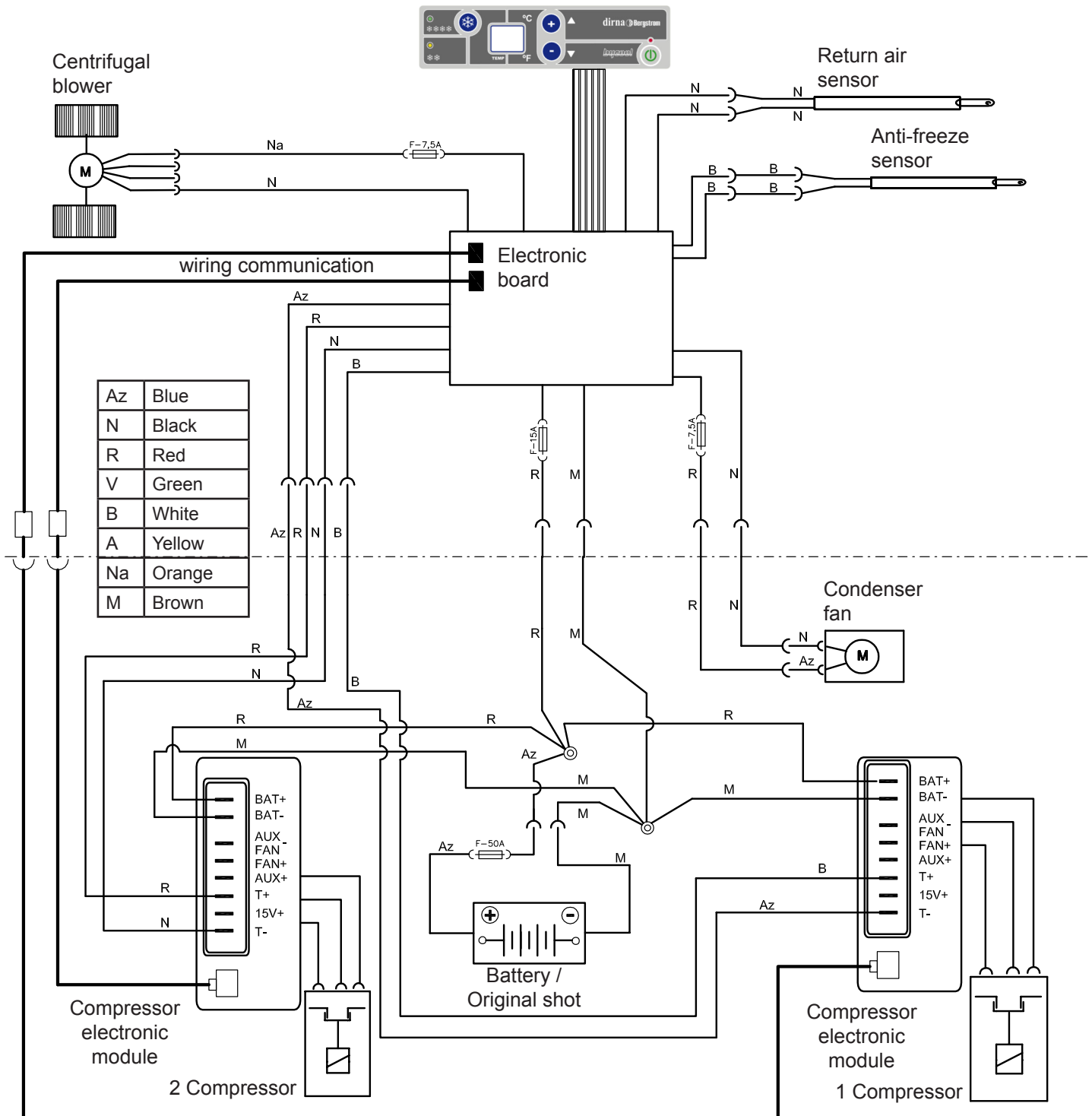

Recommandations Pour Le Montage

- Avant de commencer le montage de l'appareil, prière de lire les instructions et de les suivre attentivement.
- Utiliser les outils convenant à chaque opération.

Electricity

- Déconnecter la clé de contact.
- Déconnecter la batterie avant de commencer le montage.
- Vérifier le câblage des composants électriques et leur correcte installation.



Attention

Si pendant le montage l'équipement est incliné, il faudra attendre au moins 60 minutes avant de le mettre en marche une fois qu'il aura été remis sur sa position horizontale.



Attention

Lors de l'installation de l'appareil d'air conditionné sur le toit, il faudra protéger la partie supérieure de la cabine avec un linge ou une couverture de protection afin d'éviter les éventuelles égratignures. Durant l'installation du **Compact**, tenir compte du fait que normalement les cabines pourvues d'écotille possède une structure suffisamment solide pour supporter le poids de l'appareil. Cependant, si ce n'est pas le cas et qu'il est nécessaire de découper le toit ou même si disposant d'écotille, la structure n'est pas suffisamment rigide (si elle était en fibre, plastique, etc.) il appartiendra à l'installateur de décider s'il faut renforcer le toit pour éviter toute déformation, rupture ou voie d'eau, etc., et prendre les mesures nécessaires à cet effet.

Outils

Jeu de clés Torx
 Jeu de clés Allen
 Clé fixe 10, 13, 14
 Ciseaux
 Mètre

Documentation included

Instructions de montage	1001261106
Liste de recharges	220RE00214

Symbologie



Fragile



Attention aux coupures !



Risque électrique



Garantie



L'installateur devra posséder la formation pertinente en air conditionné sur véhicules.



dirna Bergstrom, s.l., ne sera pas responsable des dommages ou des bris dérivés d'une installation ou d'une manipulation incorrecte ni des modifications réalisées sans autorisation expresse par écrit.



Appareil pré-chargé de gaz réfrigérant. (Ne pas manipuler le circuit de gaz réfrigérant).



Voir **la procédure de garantie** du produit au **Diagnostic de problèmes**.



Voir le **Guide de l'Usager** de l'appareil pour le fonctionnement correcte de la télécommande et du tableau de commande.



Après l'installation, vous devez fournir à l'utilisateur: Manuel d'utilisation, garantie et diagnostic de pannes.

 Avant de commencer le montage, il faut monter la grille d'entrée d'air avant.



1 Démontez la console originale en tirant l'extrémité des lumières pour accéder aux vis de fixation.



2

Nettoyer la zone de l'écouille en cas de saleté et de présence de graisse adhérente avant de coller le joint EPDM. Coller le joint EPDM 30x25 sur le bossage du contour du creux de l'écouille.



3

COMMENT COUPER LE JOINT EPDM POUR EVITER LES FILTRATIONS DANS LA CABINE

- A- Coller le joint en maintenant une protection en papier de 100 mm de chaque côté.
- B- Retirer les deux morceaux de papier.
- C- Coller en faisant pression sur les deux extrémités.

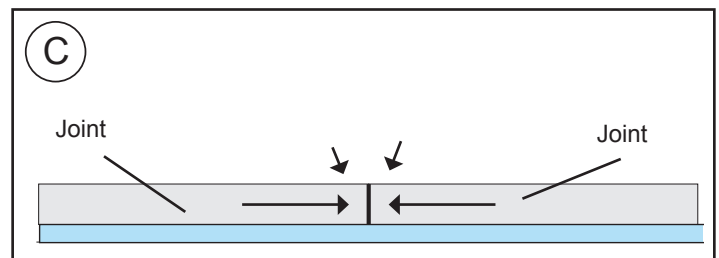
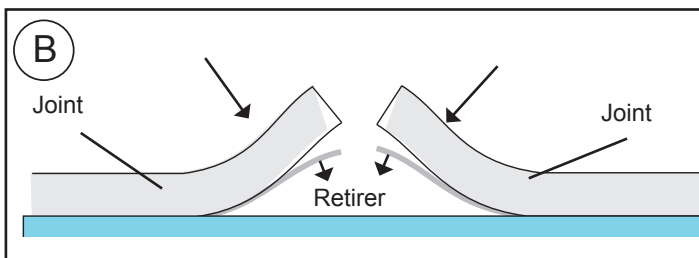
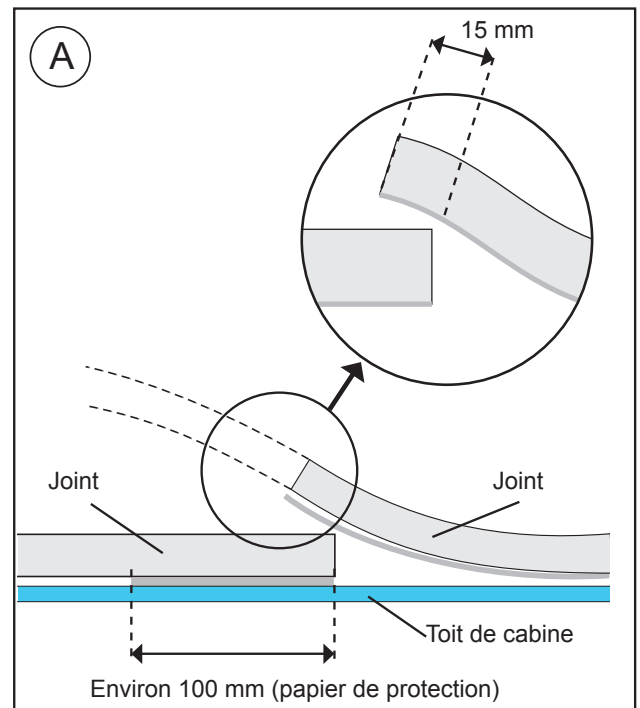

4

EXTÉRIEUR CABINE : placer l'équipement dans le creux de l'écouille.

ATTENTION: avant de placer l'équipement dans le creux de l'écouille, il faut vérifier que les sorties d'écoulement ne soient pas bouchées par le joint EPDM.

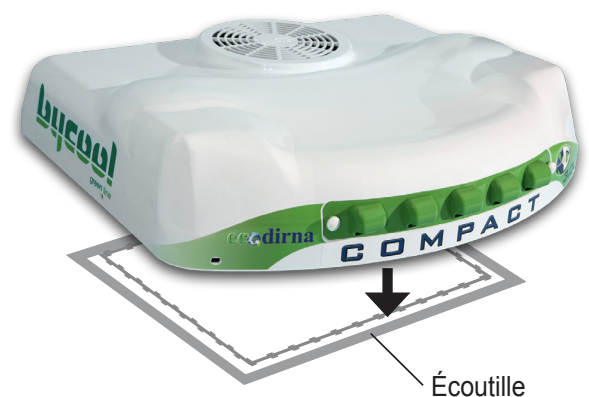

5 Placer le couplage canalisateur en caoutchouc mousse en laissant la partie la plus molle sur la base de l'équipement.



6 Monter les rondelles dans les séparateurs, tel que cela est indiqué.

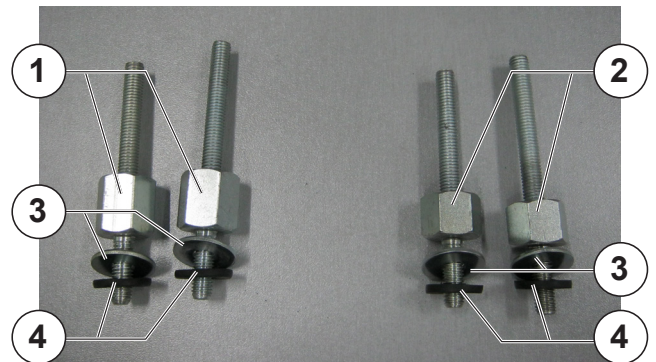

- 1 Séparateur 22 mm
- 2 Séparateur 17 mm
- 3 Rondelle plate Ø 8 surface large
- 4 Rondelle caoutchouc Ø 20 x Ø 7 x 3 mm

7 Monter les rondelles dans les séparateurs, tel que cela est indiqué.

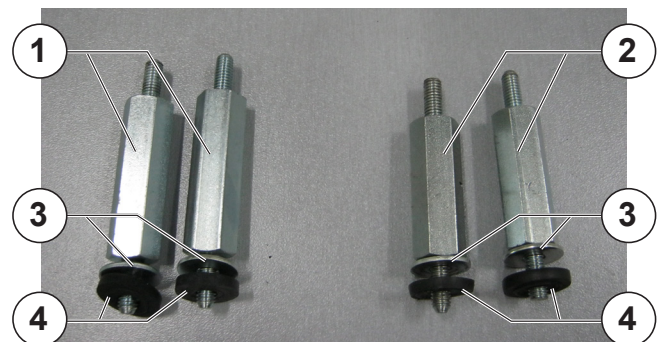

- 1 Séparateur 50 mm
- 2 Séparateur 43 mm
- 3 Rondelle plate Ø 8 surface large
- 4 Rondelle caoutchouc Ø 18 x Ø 6 x 3 mm

8 Monter et serrer les séparateurs en considérant la position selon les mesures.



- 1 Séparateur M8 22 mm
- 2 Séparateur M8 17 mm
- 3 Séparateur M8 50 mm
- 4 Séparateur M8 43 mm

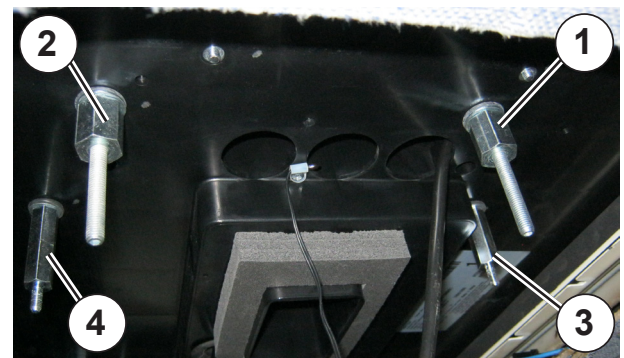

- 1 Séparateur M8 22 mm
- 2 Séparateur M8 17 mm
- 3 Séparateur M8 50 mm
- 4 Séparateur M8 43 mm

9 Introduire des supports dans les goujons M8 sous la tapiserie. Placer (4) rondelles plates Ø8 surface large et (4) écrous M8 autobloquants sans serrer totalement.

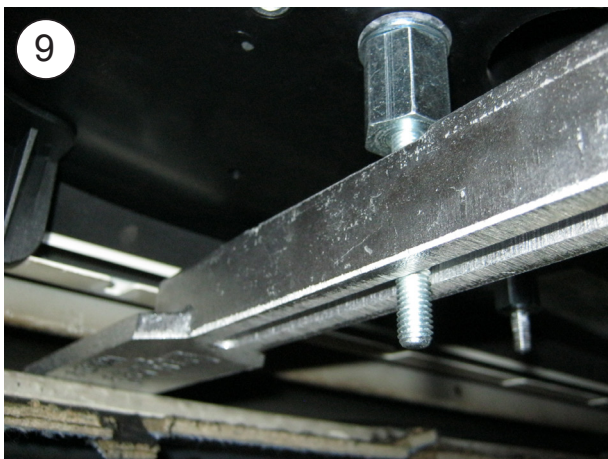



ATTENTION: Attention de ne pas pincer le câblage de l'écouille.



10

Entre la base et le panneau inférieur de distribution d'air, connecter (2) boîtes à deux voies de capteur antigel (câbles blancs) et capteur d'air de retour (câbles noirs), la boîte à 4 voies du souffleur, (2) câbles de communication et la boîte à 8 voies de câblage à la connexion avec contrôle électronique.

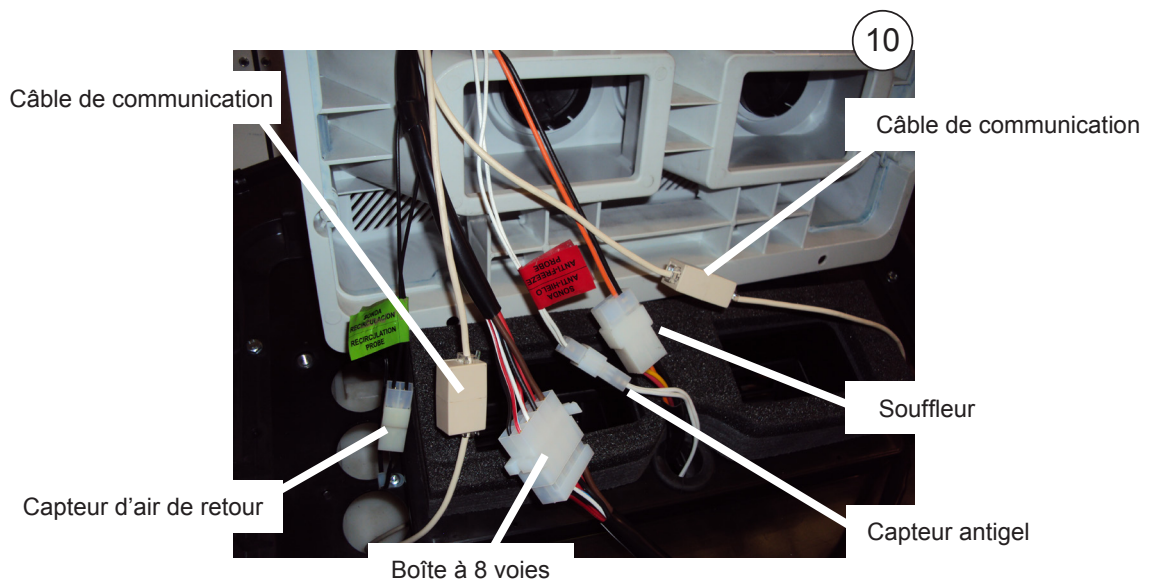

- 11** Monter le panneau intérieur de distribution d'air avec (4) hexagones en considérant la position selon les mesures.

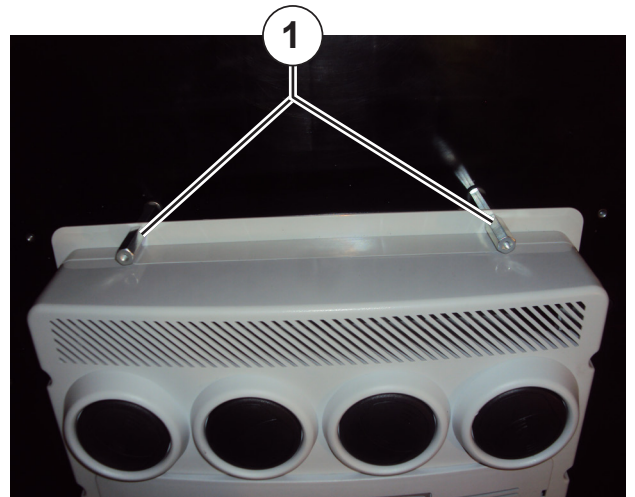
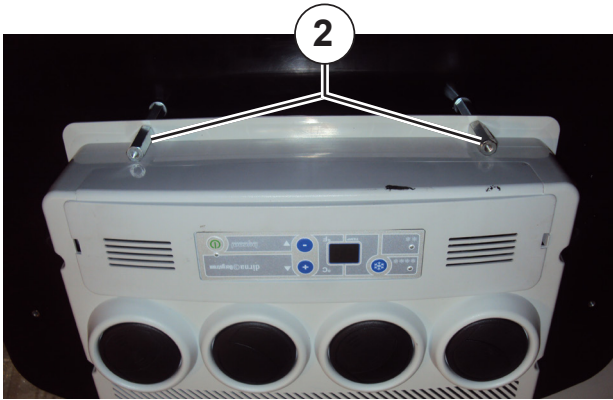

- 1 Séparateur 50 mm sur la partie avant
2 Séparateur 43 mm sur la partie arrière

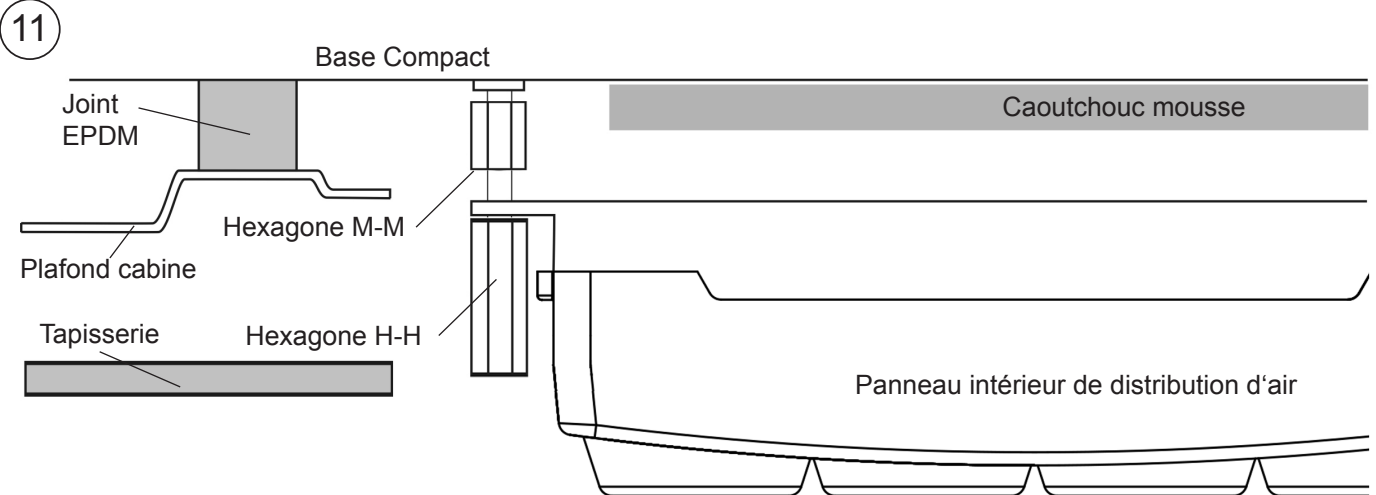

- 12** Monter la console avec (4) vis M6x16 et centrer l'équipement jusqu'à faire coïncider la console à l'emplacement de la tapisserie où la console originale était installée.



13

Une fois centré, démonter la console et serrer les supports jusqu'à ce qu'ils atteignent la butée avec les hexagones.

**14**

Vérifier de l'extérieur que les écoulements de l'équipement soient libres et qu'ils n'interfèrent pas avec le joint EPDM de l'équipement.

15

Monter à nouveau la console avec les vis M6x16 en serrant jusqu'à atteindre les hexagones.



16

Connecter les lumières et les emboîter en exerçant une pression sur la console.



VUE EXPLOSÉE JUSQU'À LA FIXATION DES SUPPORTS DE FIXATION

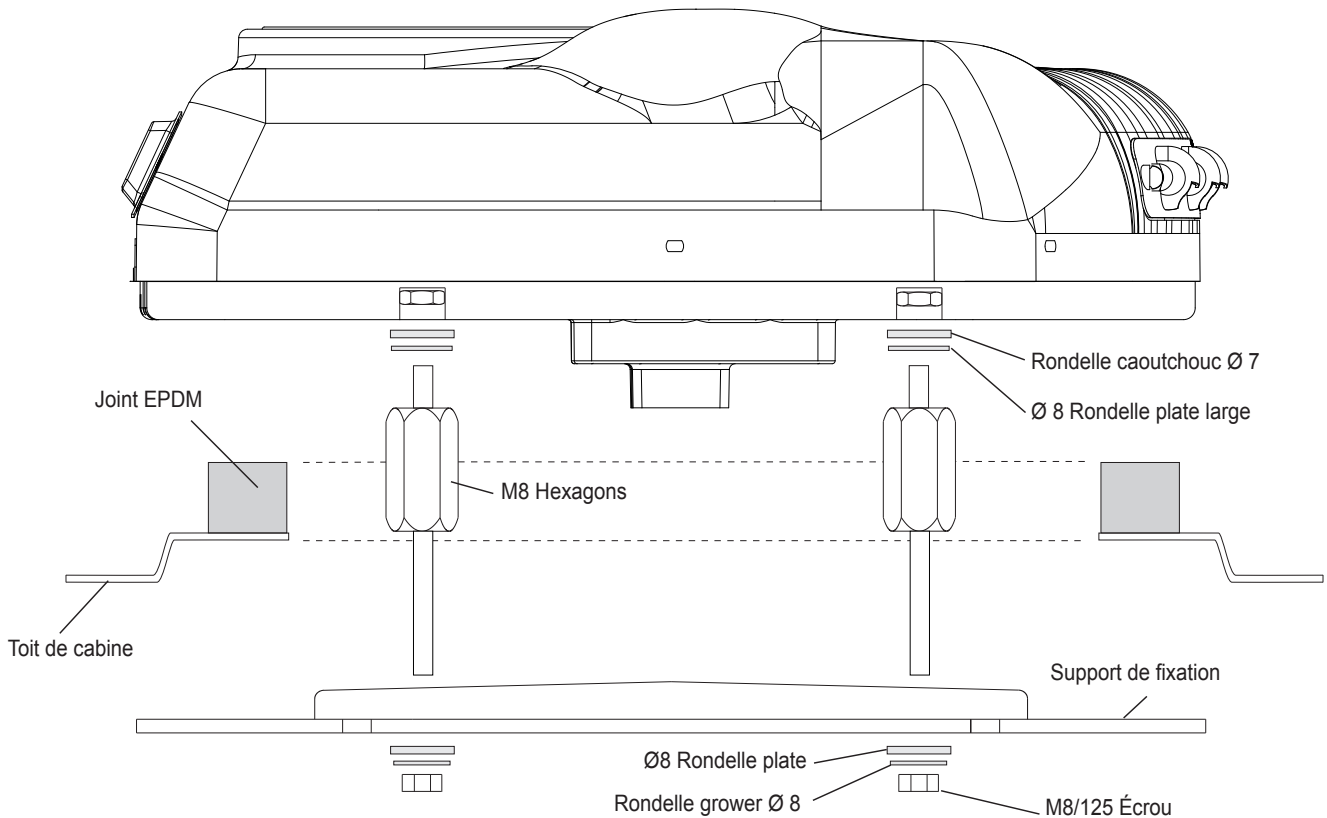

VUE EXPLOSÉE JUSQU'À FIXATION DES CONSOLES

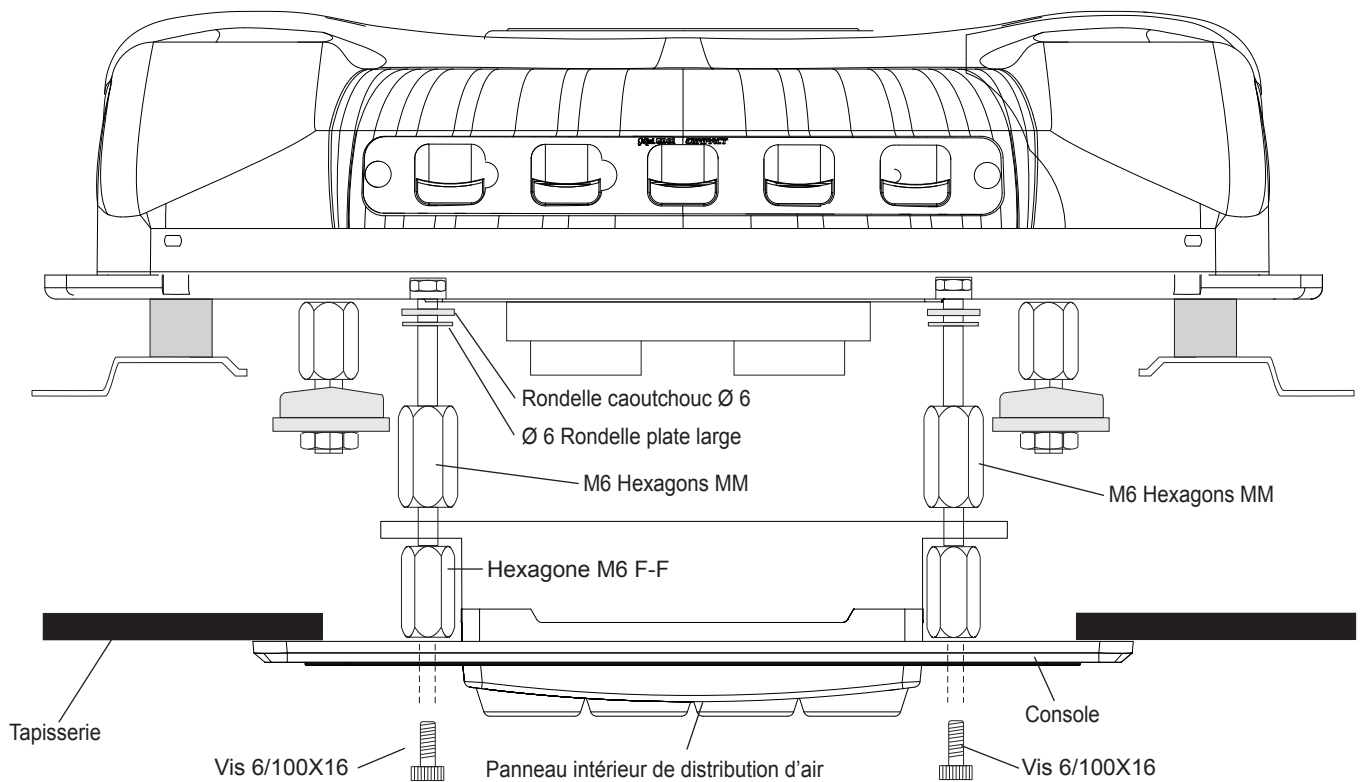

17

Fixer le câblage à l'aide des supports avec de l'adhésif et des brides à la cabine, support spoiler latéral et câblage original.

ATTENTION : nettoyer correctement la zone avant de coller les supports avec de l'adhésif.

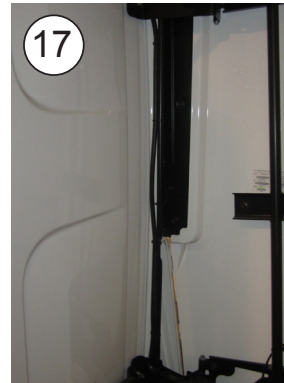

18

Connecter le câblage d'alimentation inférieur au supérieur en laissant une distance suffisante pour éviter sa cassure en raison des mouvements de la cabine.

TRES IMPORTANT : placer des adhésifs de danger sur l'union du câblage et sur le dispositif de levage de la cabine, afin d'éviter la déconnexion des broches du câblage en cas d'abattre la cabine.

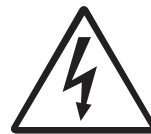

19 Démontez le protecteur du moteur (*) et passez le câblage vers les batteries dans le châssis en le fixant avec les câblages d'origine.

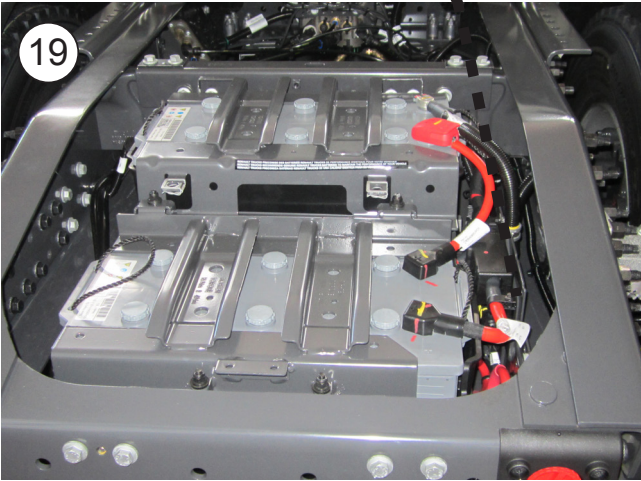
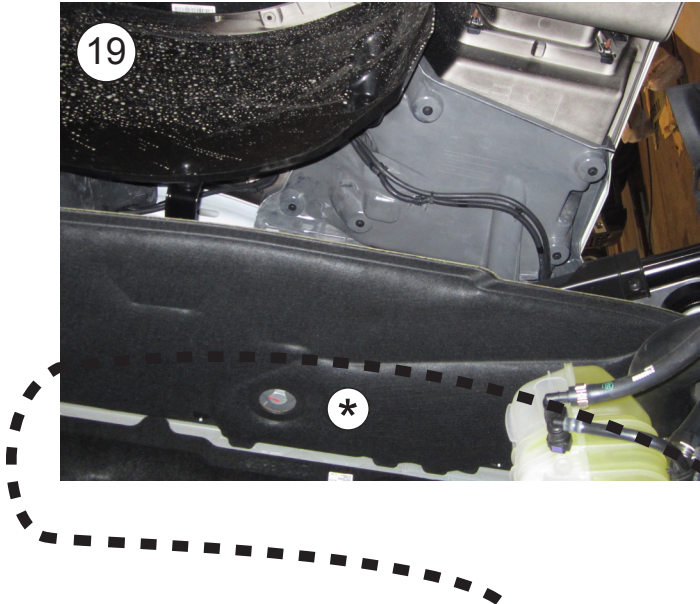

20 Démontez la boîte à fusibles (*) et connectez (+) à celle-ci et (-) à la prise de masses d'origine.



Schéma électrique

AVIS IMPORTANT !

Attention de ne pas inverser les polarités au moment de connecter l'alimentation à l'équipement. Si cela se produisait, la plaque ne s'allumerait pas, l'équipement ne fonctionnerait pas et des dommages irréparables seraient causés dans les modules des compresseurs.

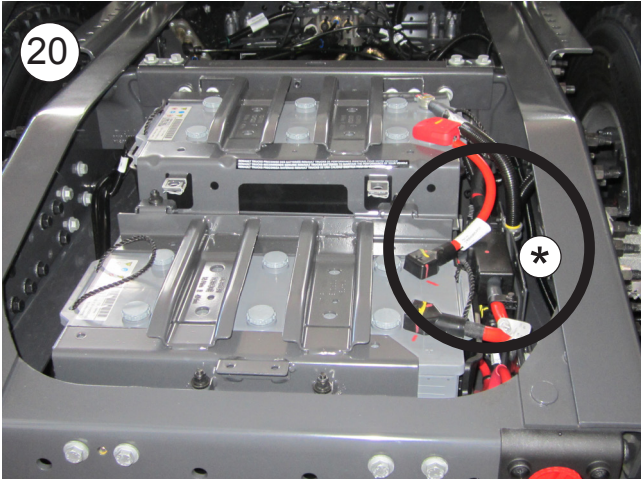
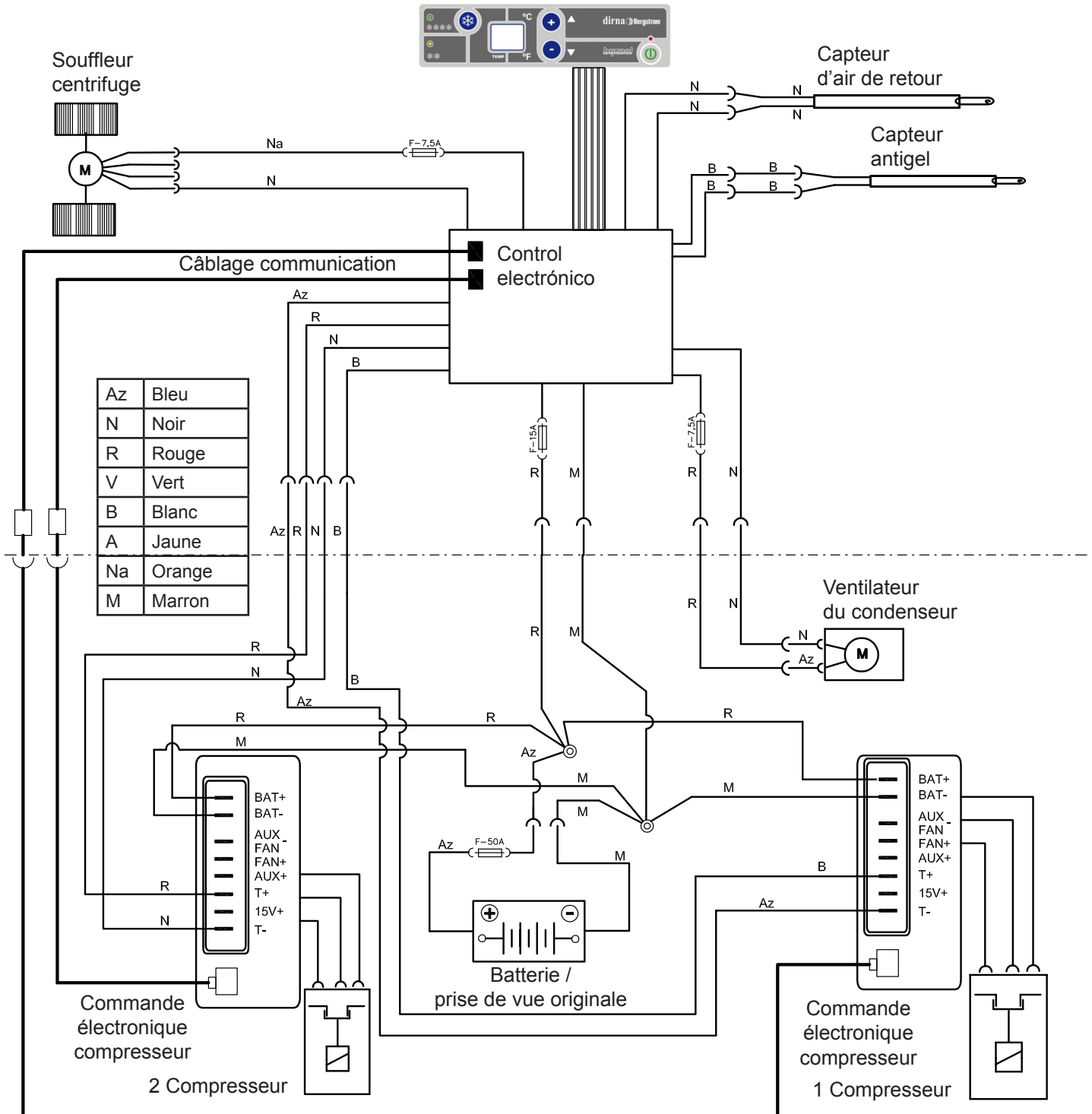

Empfehlungen Zur montage

- Vor und während der Montage bitte diese Anweisungen lesen und beachten.
- Benutzen Sie für jeden Arbeitsschritt die geeigneten Werkzeuge.

Elektrizität

- Zündschlüssel abziehen.
- Vor Montagebeginn die Batterie abklemmen.
- Den ordnungsgemäßen Anschluss und die korrekte Installation der Elektrokomponenten überprüfen.

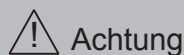

Achtung

Sollte sich das Gerät während der Montage neigen, muss man mindestens 60 Minuten warten, nachdem es wieder in die horizontale Lage gebracht wurde, um es wieder einzuschalten.

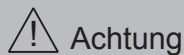

Achtung

Wird die Klimaanlage im Kabinendach installiert, muss der obere Teil der Kabine mit einem Tuch oder einer Decke gegen eventuelle Kratzer geschützt werden. Bei der Installation der **Compact** auf dem Kabinendach muss darauf geachtet werden, dass mit Luken ausgestattete Kabinen über eine ausreichend stabile Struktur verfügen, um das Gewicht des Geräts stand zu halten. Sollte das Fahrzeug über keine Luke verfügen und sollte es notwendig sein, das Kabinendach aufzuschneiden, bzw. sollte die vorhandene Struktur nicht ausreichend stabil sein (z.B. wenn sie aus Faser, Kunststoff usw. hergestellt ist), obliegt es dem Installateur zu entscheiden, ob das Kabinendach zur Vermeidung von Verformungen, Brüchen, undichten Stellen usw. verstärkt werden muss, und die hierfür notwendigen Mittel bereit zu stellen.

Werkzeuge

- Torx-Schraubenschlüssel
- Inbusschraubenschlüssel
- 10er, 13er, 14er Schraubenschlüssel
- Schere
- Metermaß

Mitgelieferte unterlagen

Montageanweisungen	1001261106
Ersatzteilliste	220RE00214

Symbologie



Fragile



Attention aux coupures !



Risque électrique

Warnhinweise



Der Installateur muss im Bereich Fahrzeug-Klimaanlagen ausreichend geschult sein.



dirna Bergstrom, s.l. übernimmt keine Verantwortung für Schäden oder Brüche aufgrund einer nicht ordnungsgemäßen Installation oder Bedienung des Geräts oder den Austausch von Teilen bzw. Umbauten, die ohne die erforderliche schriftliche Genehmigung durchgeführt wurden.



Mit Kältemittel vorgefülltes Gerät.
(Kältemittelkreislauf nicht manipulieren).



Siehe **Garantieverfahren** des Produkts in der **Fehlerdiagnose**.



Siehe **Benutzerleitfaden** des Geräts für den ordnungsgemäßen Betrieb der Fernbedienung und des Bedienfelds.



Die folgenden Unterlagen müssen dem Benutzer nach der Installation ausgehändigt werden:
Benutzerleitfaden, Garantie und Fehlerdiagnose.

 Vor Montagebeginn vorderes Lufteintrittsgitter montieren.



1 Originalkonsole durch Ziehen am Ende der Lampen abnehmen, um auf die Befestigungsschrauben zugreifen zu können.



2

Den Bereich der Zugangsklappe von möglichen Verschmutzungen und Fett reinigen, bevor die EPDM Dichtung angebracht wird. Die EPDM Dichtung 30x25 mit Klebstoff an der Hohlkehle des Formrands des Schachts der Zugangsklappe befestigen.



3

WIE DIE EPDM-DICHTUNG GESCHNITTEN WIRD, UM WASSERUNDICHTIGKEITEN IN DIE KABINE ZU VERMEIDEN

- A- Dichtung aufkleben und dabei einen Papierschutz von 100 mm auf jeder Seite beibehalten.
- B- Die zwei Papierstücke entfernen.
- C- Unter Anpressen beider Enden aufkleben.

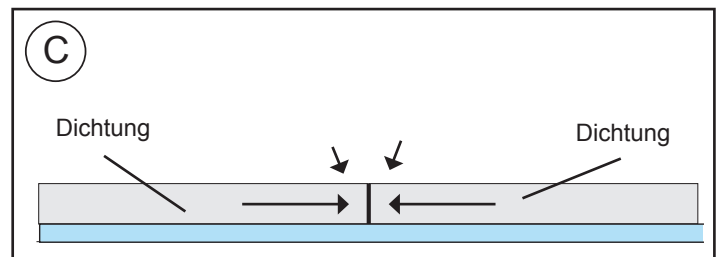
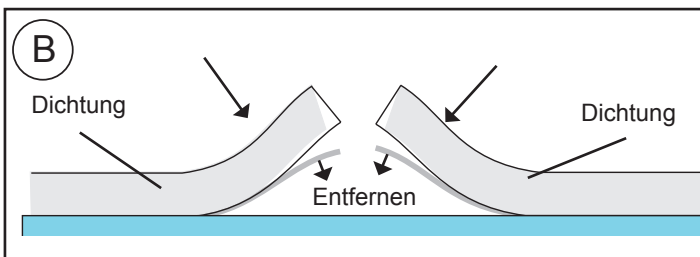
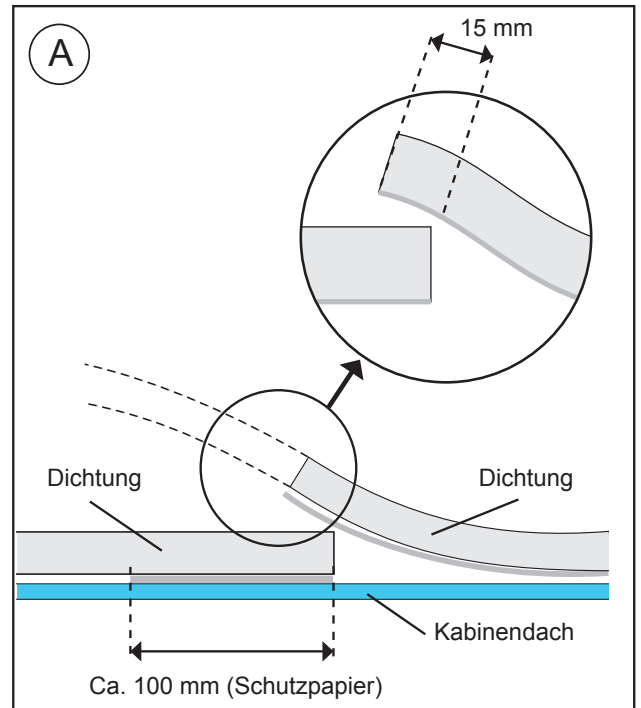

4

AUßENSTEITE DER KABINE: Das Gerät in dem Schacht der Zugangsklappe anbringen.

ACHTUNG: Bei der Anbringung des Gerätes über dem Schacht der Zugangsklappe muss überprüft werden dass die Abwasserleitungen nicht durch die EPDM Dichtung blockiert werden.



5 Eine Kupplung für die Sammelleitung anbringen, wobei der weichere Teil in dem unteren Teil des Gerätes verbleibt.



6 Einbau der Unterlegscheiben in die Abstandshalter wie angegeben:

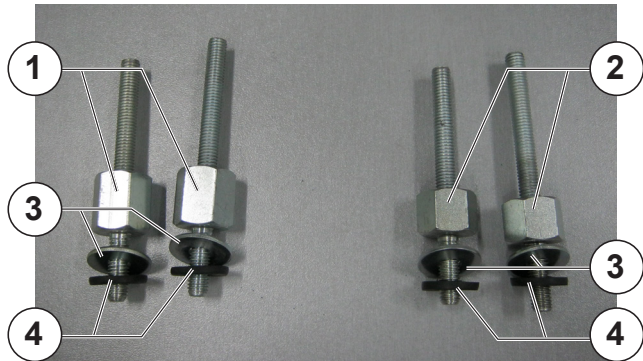

- 1 Abstandshalter 22 mm
- 2 Abstandshalter 17 mm
- 3 Unterlegscheibe flach Ø 8 Breitflansch
- 4 Unterlegscheibe Gummi Ø 20 x Ø 7 x 3 mm

7 Einbau der Unterlegscheiben in die Abstandshalter wie angegeben:

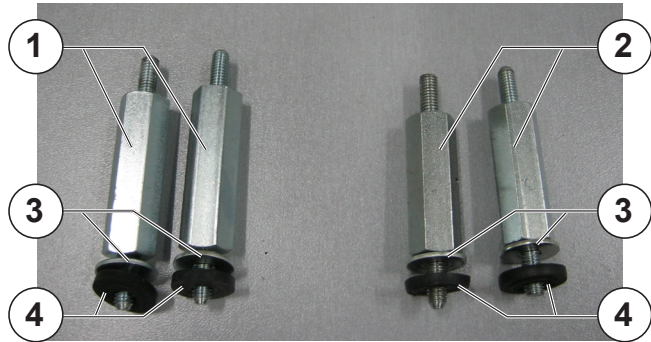

- 1 Abstandshalter 50 mm
- 2 Abstandshalter 43 mm
- 3 Unterlegscheiben flach Ø 8 Breitflansch
- 4 Unterlegscheiben Gummi Ø 18 x Ø 6 x 3 mm

8 Einbau und Anziehen der Abstandshalter unter Berücksichtigung der Position gemäß deren Abmessungen.

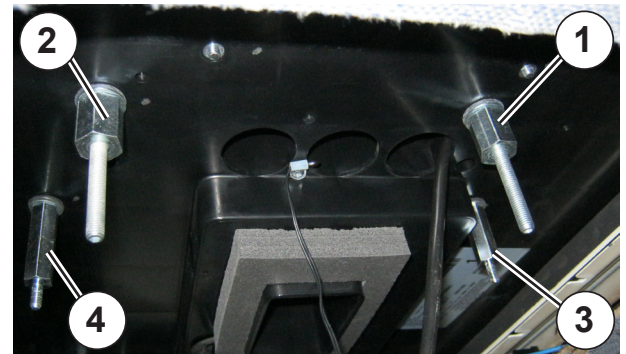

- 1 Abstandshalter M8 22 mm
- 2 Abstandshalter M8 17 mm
- 3 Abstandshalter M8 50 mm
- 4 Abstandshalter M8 43 mm

- 1 Abstandshalter M8 22 mm
- 2 Abstandshalter M8 17 mm
- 3 Abstandshalter M8 50 mm
- 4 Abstandshalter M8 43 mm

9 Halterungen auf Stiften M8 unter die Polster einführen (4) Unterlegscheiben flach Ø8 Breitflansch und (4) selbstverriegelnde Muttern M8 anbringen, ohne diese vollkommen anzuziehen.

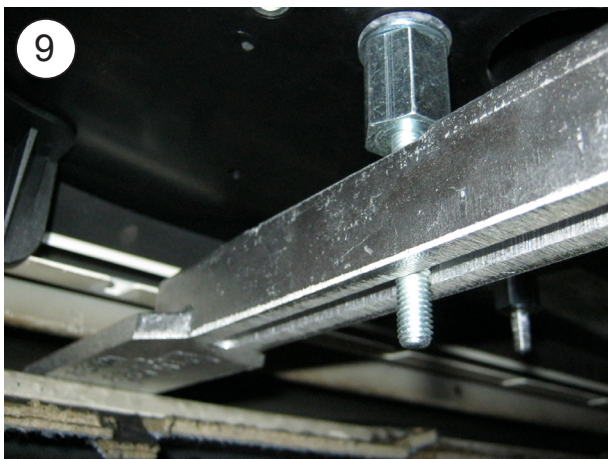

 **VORSICHT** : Bitte beachten, dass die Verkabelung der Zugangsklappe nicht eingeklemmt wird.



10 Zwischen der Grundplatte und der inneren Luftverteiltertafel (2) 2-Wege-Kästen von Frostschutzfühler (weiße Kabel) und Rückführsende (schwarze Kabel), 4-Wege-Kasten des Gebläses, (2) Kommunikationskabel und 8-Wege-Kasten der Anschlussverkabelung zur Elektroniksteuerung anschließen.

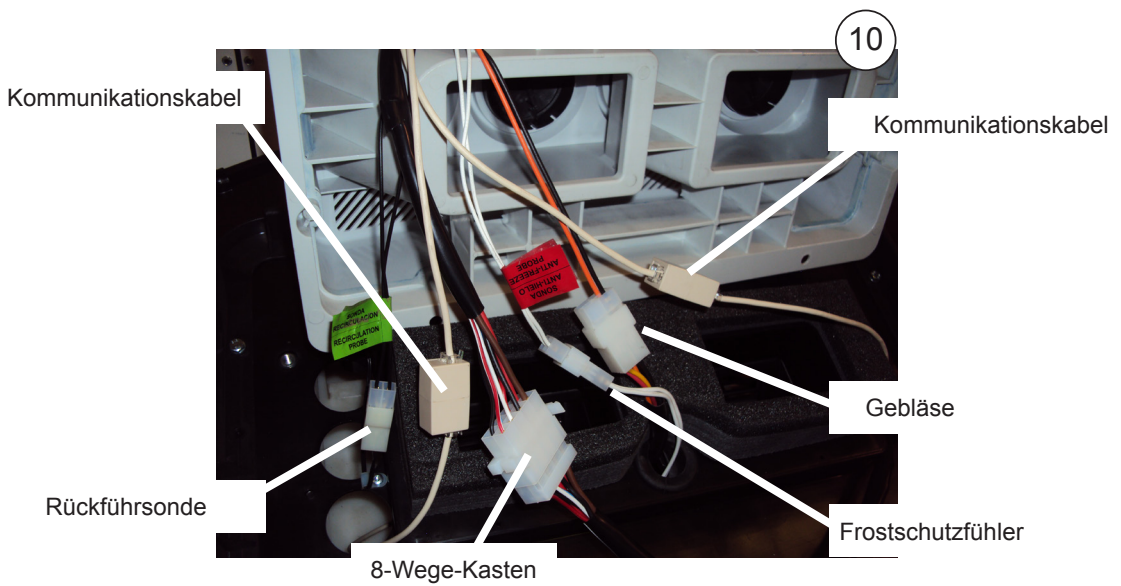

11 Die innere Verteilertafel für Luft mit (4) Sechskant montieren, unter Beachtung deren Position gemäß Abmessungen.

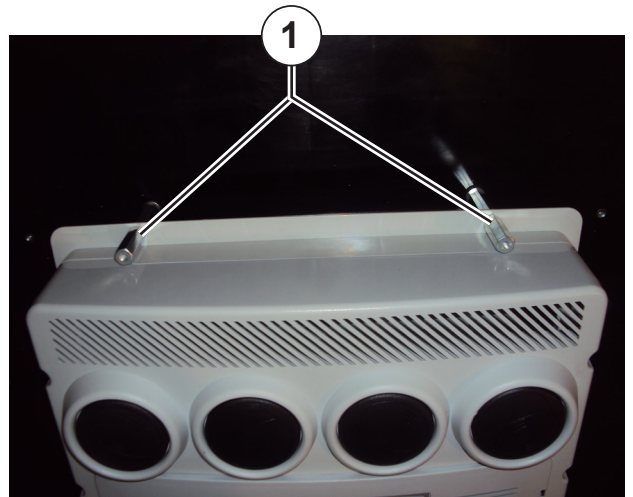

1 Abstandshalter 50 mm an der Vorderseite
2 Abstandshalter 43 mm an der Rückseite

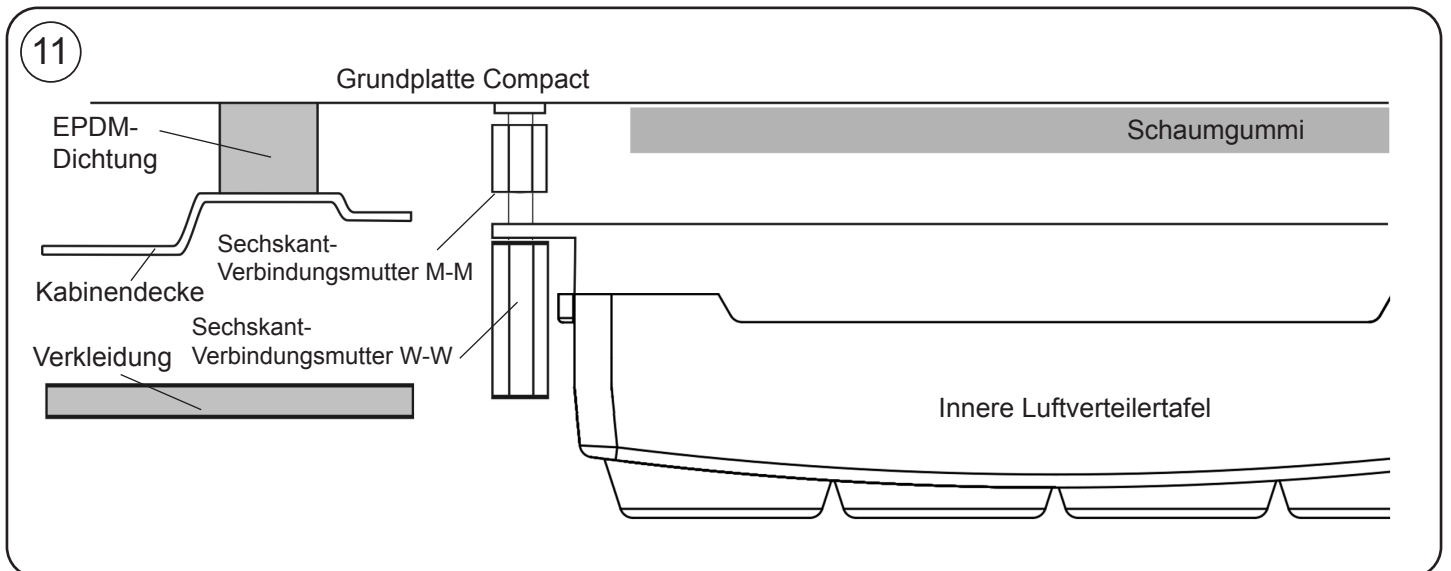
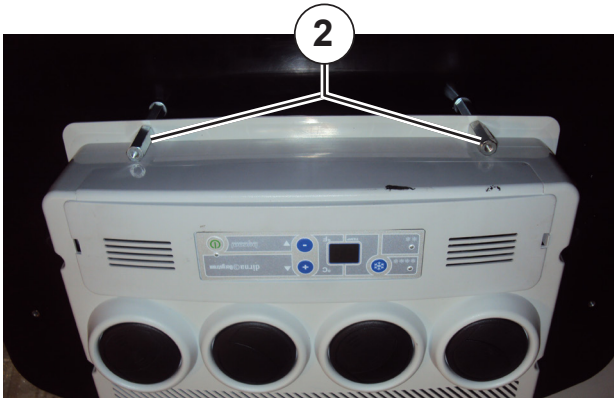

12 Konsole unter Markierung von (4) Schrauben M6x16 auflegen und Gerät zentrieren, bis sie sich an derjenigen Position der Verkleidung befindet, wo die Originalkonsole montiert war.



13

Nach erfolgter Zentrierung, die Konsole demontieren und die Halterungen bis zum Anschlag mit den Sechskant anziehen.

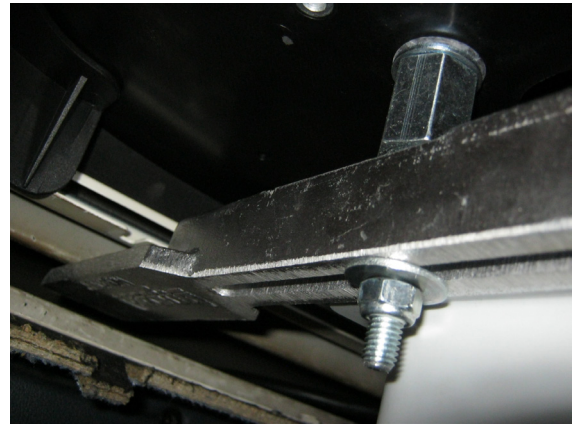

14

Von der Außenseite überprüfen, dass die Abwasserleitungen frei sind und nicht die Dichtung EPDM des Gerätes behindern.

15

Konsole erneut mit Schrauben M6x16 montieren und diese anziehen, bis sie an die Sechskant-Verbindungs-muttern anschlagen.



16

Lichter anschließen und durch Drücken auf die Konsole einrasten lassen.



EXPLOSIONSANSICHT BIS ZUR BEFESTIGUNG DER BEFESTIGUNGSAUFLAGEN

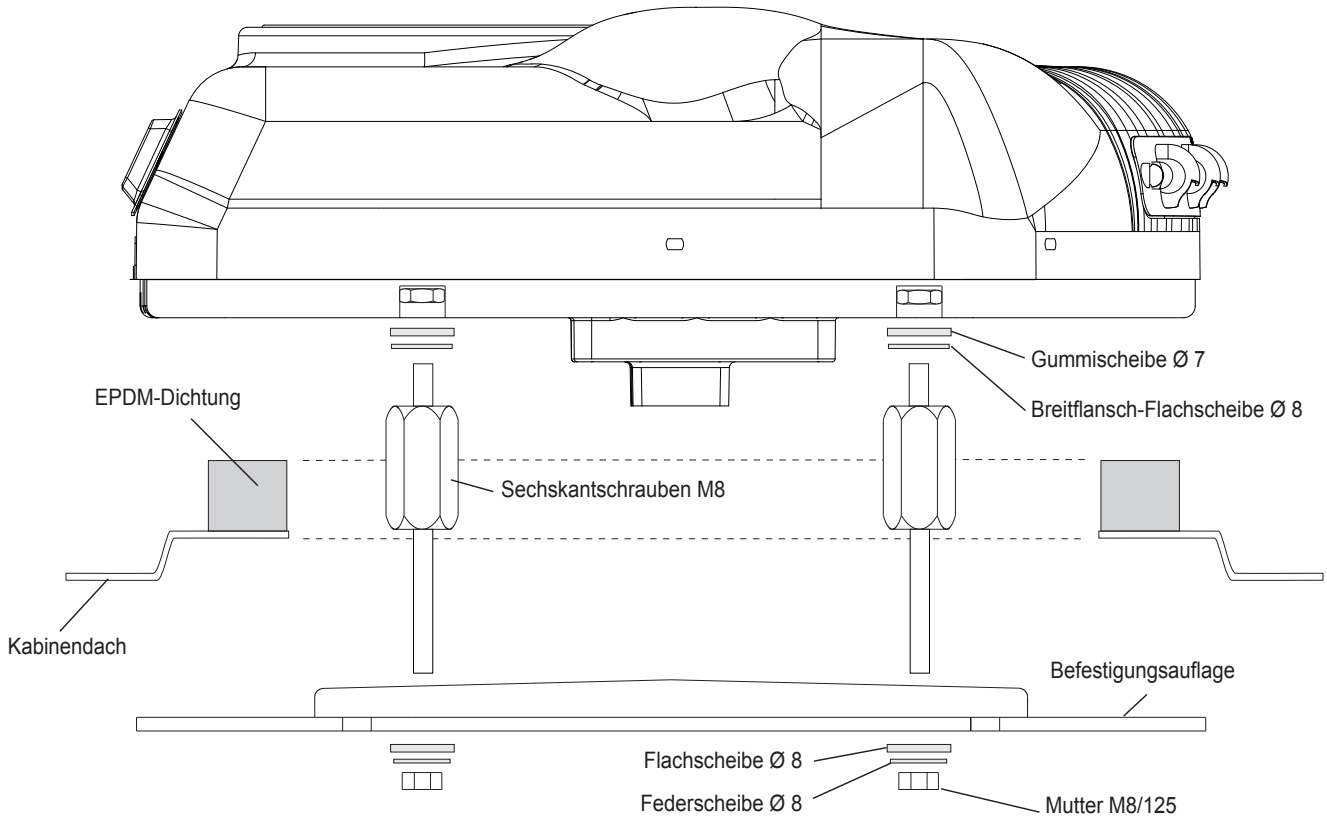

EXPLOSIONSANSICHT BIS ZUR BEFESTIGUNG DER KONSOLEN

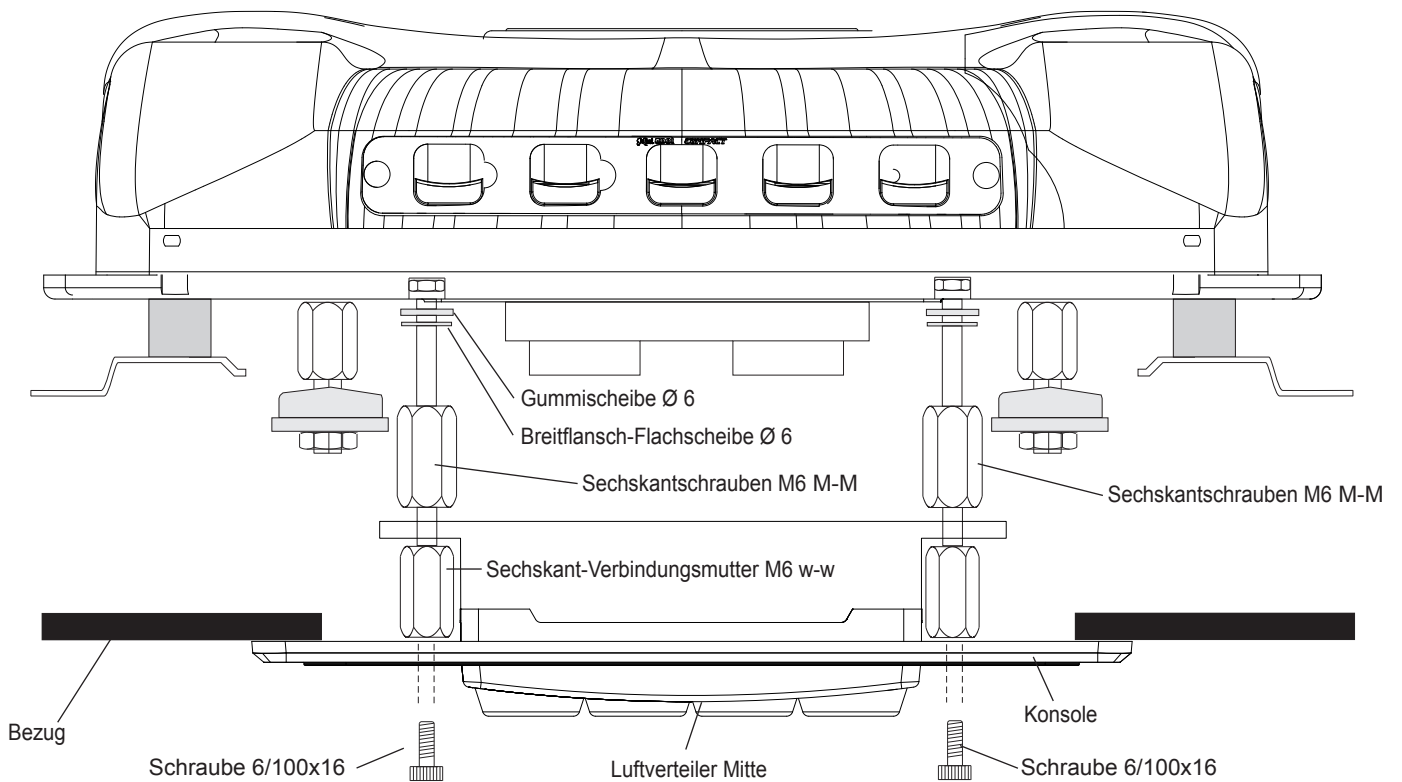

17

Die Verkabelung mit Halterungen mit Klebstoff und die Flansche an der Kabine befestigen, ebenso wie die Halterung des seitlichen Spoilers und die ursprüngliche Verkabelung.

ACHTUNG: Den Bereich gründlich reinigen, bevor die Halterungen mit Klebstoff befestigt werden. pegar los soportes con adhesivo.

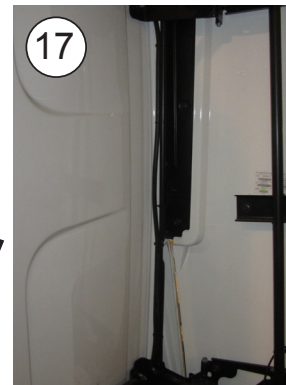

18

Die untere und obere Einspeisungsverkabelung verbinden, indem ausreichend Abstand eingehalten wird, um zu vermeiden, dass sie durch die Bewegung der Kabine beschädigt werden.

SEHR WICHTIG: Warnschilder vor Gefahren an den Verbindungsstellen der Verkabelung und an den Hubmechanismen der Kabine anbringen und sollte sich die Kabine schwenken, die Trennung der Verkabelung vornehmen.

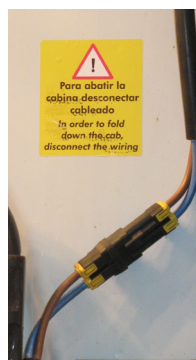

19 Die Motorabdeckung (*) demontieren und die Verkabelung zu den Batterien innerhalb des Fahrgestells einführen und sie an der ursprünglichen Verkabelung befestigen.

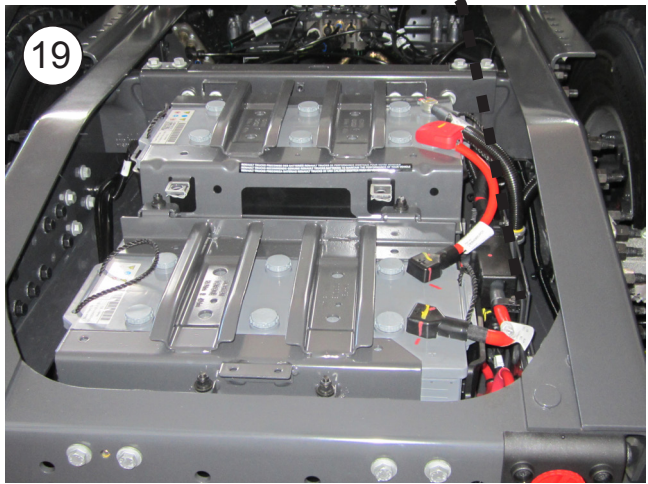
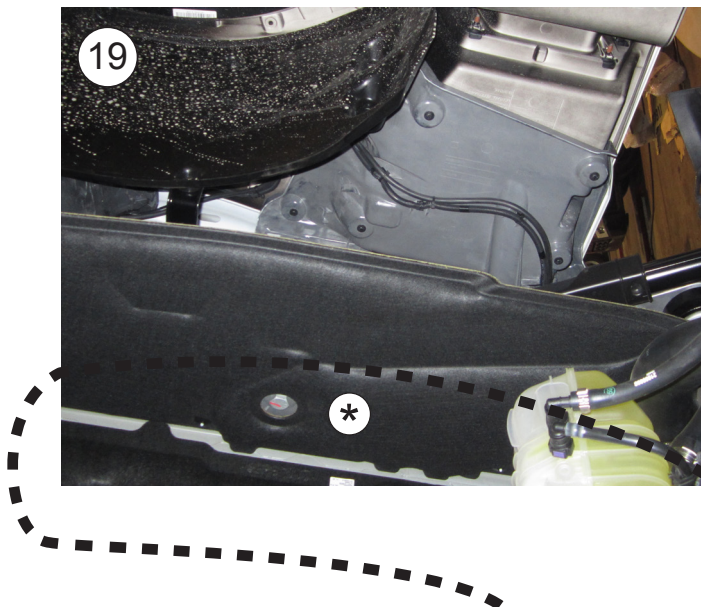

20 Den Sicherungskasten (*) demontieren und (+) an diesen anschließen und (-) an die ursprüngliche Erdung anschließen.

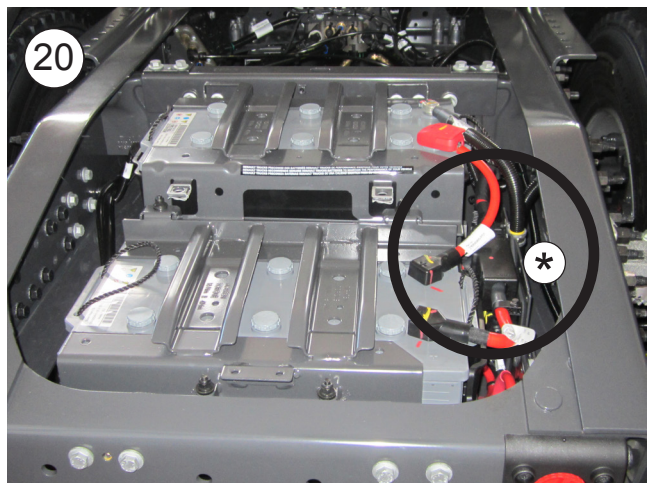

Schaltplan

WICHTIGER HINWEIS!

Darauf achten, dass die Polaritäten beim Anschluss der Stromversorgung an das Gerät nicht vertauscht werden. Ist dies der Fall, schaltet sich die Elektroniktafel nicht ein, das Gerät funktioniert nicht und es kommt zu irreparablen Schäden an den Kompressormodulen.

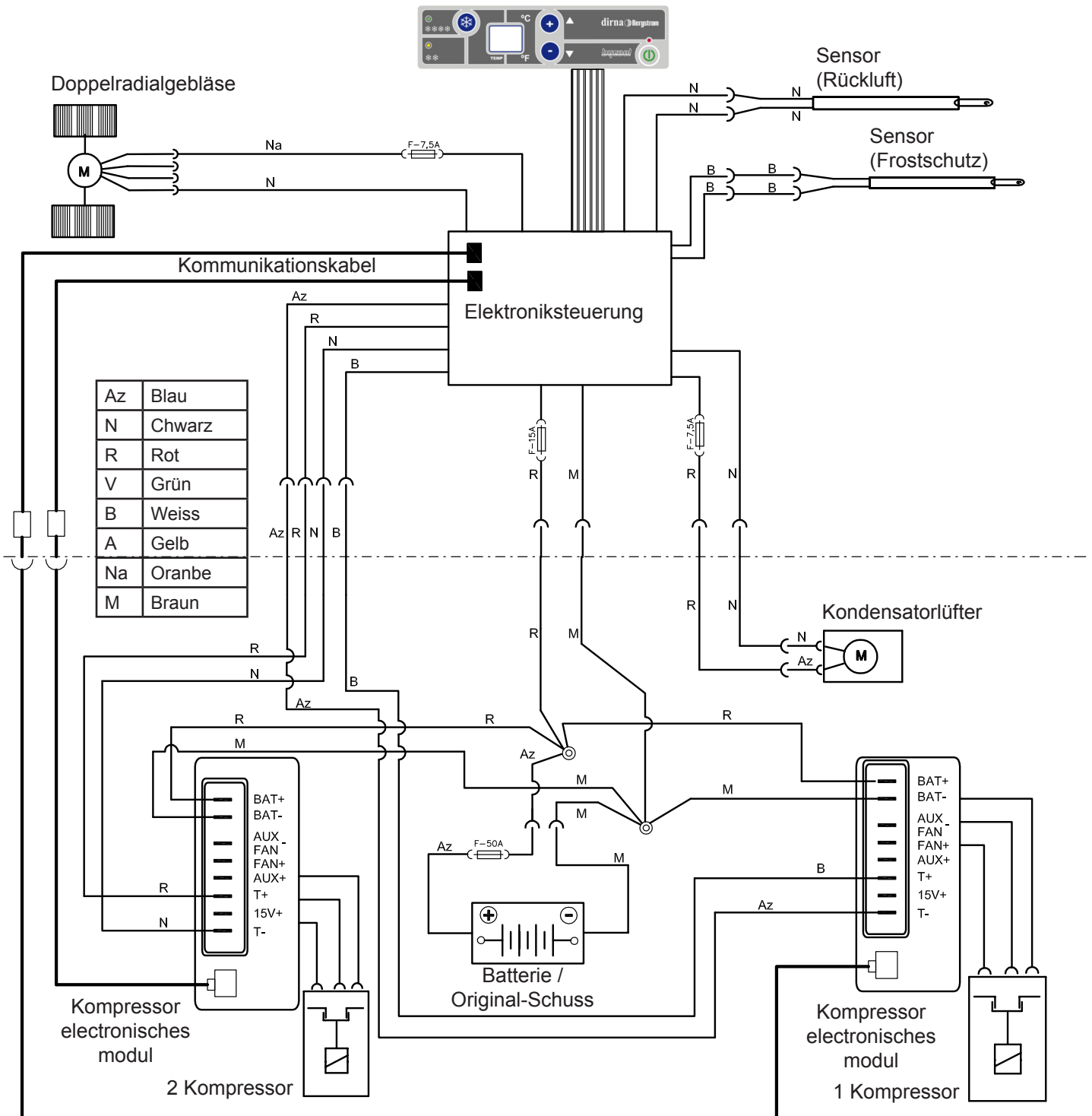

Suggerimenti per il montaggio

- Prima di cominciare il montaggio, leggere attentamente le istruzioni e rispettarle nel corso dello stesso.
- Usare gli attrezzi più adatti ad ogni operazione.

Elettricità

- Scollegare la chiave di contatto.
- Scollegare la batteria prima di cominciare il montaggio.
- Assicurarsi di aver effettuato correttamente l'installazione e il collegamento dei componenti elettrici.

Attenzione

Se durante il montaggio si inclina l'impianto, prima di rimetterlo in funzione occorre attendere almeno 60 minuti dal momento in cui è di nuovo in posizione orizzontale.

Attenzione

Quando si installa l'impianto di aria condizionata sul tettuccio, bisogna proteggere la parte superiore della cabina con uno straccio o una coperta per evitare eventuali graffi. Per l'installazione del **Compact**, tenere presente che normalmente le cabine munite di oblò dispongono di una struttura abbastanza solida per sostenere il peso dell'impianto. Tuttavia, se così non fosse e se fosse necessario tagliare il tettuccio, o se in presenza di oblò la struttura non fosse abbastanza rigida (se fosse di fibra, plastica, ecc.), è responsabilità dell'installatore decidere se occorre rinforzare il tettuccio per evitare qualsiasi deformazione, rottura o penetrazione d'acqua, ecc., prendendo le misure necessarie per evitarlo.

Attrezzi

Kit di chiavi Torx
 Kit di chiavi Allen
 Chiave fissa 10, 13, 14
 Forbici
 Metro a nastro

Documentazione allegata

Istruzioni di montaggio	1001261106
Elenco ricambi	220RE00214

Simbologia



Fragile



Attenzione alle mani



Tensione elettrica pericolosa

Avvertenze



L'installatore deve essere in possesso della formazione necessaria in materia di aria condizionata per veicoli.



dirna Bergstrom, s.l. declina ogni responsabilità per danni o rotture derivanti dall'errata installazione o dall'errato uso dell'impianto o da sostituzioni o modifiche effettuate senza la necessaria autorizzazione per iscritto.



Impianto precaricato con gas refrigerante. (Non manomettere il circuito di gas refrigerante).



Vedi la **procedura di garanzia** del prodotto in **Diagnosi dei problemi**.



Vedi la **Guida dell'utente** dell'impianto per il corretto funzionamento del telecomando e del pannello di controllo.



I seguenti documenti devono essere consegnati all'utente una volta conclusa l'installazione: **Guida dell'utente, Garanzia e Diagnosi dei problemi**.

 Prima di cominciare il montaggio, montare la griglia anteriore d'entrata dell'aria.



1 Smontare la console originale, tirando dall'estremità delle luci per accedere alle viti di fissaggio.



2 Pulire l'area del tettuccio apribile e rimuovere lo sporco e il grasso eventualmente presenti prima di incollare la guarnizione EPDM. Incollare la guarnizione EPDM 30x25 lungo il rialzo perimetrale del vano del tettuccio apribile.



3 **COME TAGLIARE LA GUARNIZIONE EPDM PER EVITARE INFILTRAZIONI NELLA CABINA**

- A- Incollare la guarnizione mantenendo una protezione di carta di 100 mm su ogni lato.
- B- Rimuovere i due pezzi di carta.
- C- Incollare premendo su entrambe le estremità.

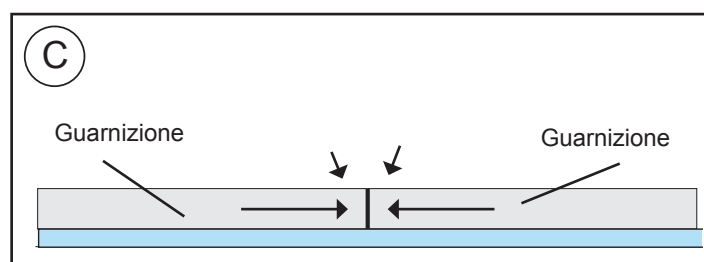
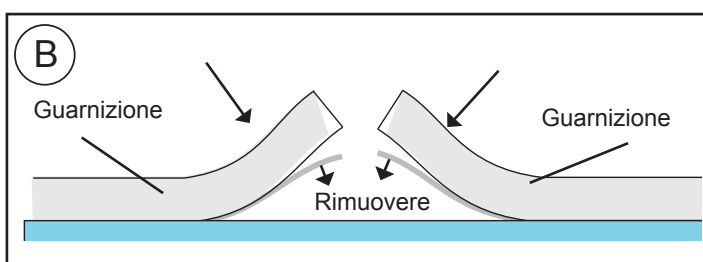
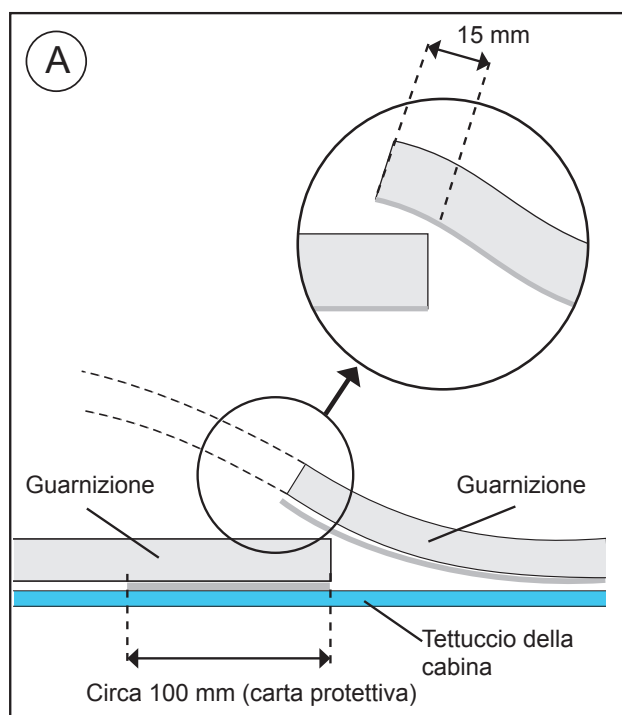

4 **ESTERNO CABINA:** inserire l'impianto nel vano del tettuccio apribile.

ATTENZIONE: nell'inserimento dell'impianto nel vano del tettuccio apribile, controllare che le uscite di scarico non siano ostruite dalla guarnizione EPDM.

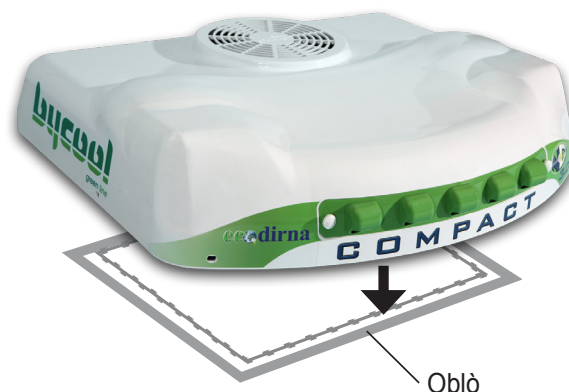

5 Montare la sede del canalizzatore con la parte più morbida sulla base dell'impianto.



6 Montare le rondelle sui distanziatori come indicato.

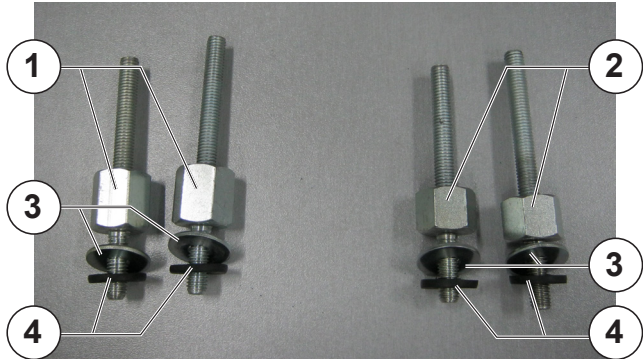

- 1 Distanziatore 22 mm
- 2 Distanziatore 17 mm
- 3 Rondella piana Ø 8 a testa larga
- 4 Rondella di gomma Ø 20 x Ø 7 x 3 mm

7 Montare le rondelle sui distanziatori come indicato.

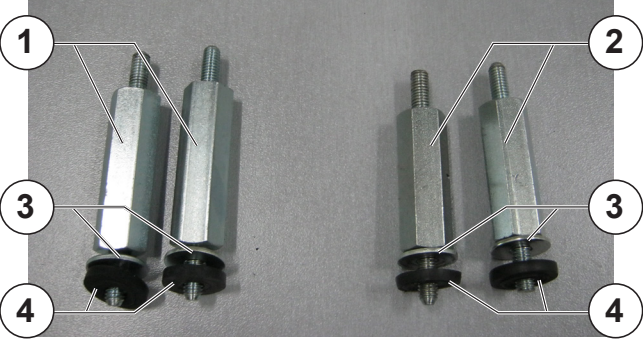

- 1 Distanziatore 50 mm
- 2 Distanziatore 43 mm
- 3 Rondella piana Ø 8 a testa larga
- 4 Rondella di gomma Ø 18 x Ø 6 x 3 mm

8 Montare e stringere i distanziatori tenendo conto della posizione a seconda delle relative misure.



- 1 Distanziatore M8 22 mm
- 2 Distanziatore M8 17 mm
- 3 Distanziatore M8 50 mm
- 4 Distanziatore M8 43 mm

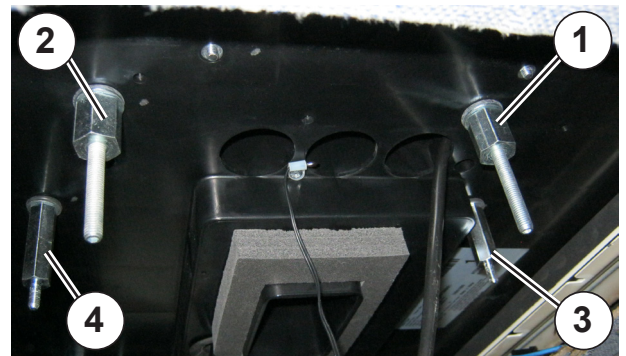

- 1 Distanziatore M8 22 mm
- 2 Distanziatore M8 17 mm
- 3 Distanziatore M8 50 mm
- 4 Distanziatore M8 43 mm

9 Inserire i supporti sulle viti prigioniere M8 sotto la tappezzeria. Inserire (4) rondelle piane Ø8 a testa larga e (4) dadi M8 autobloccanti senza stringere completamente.

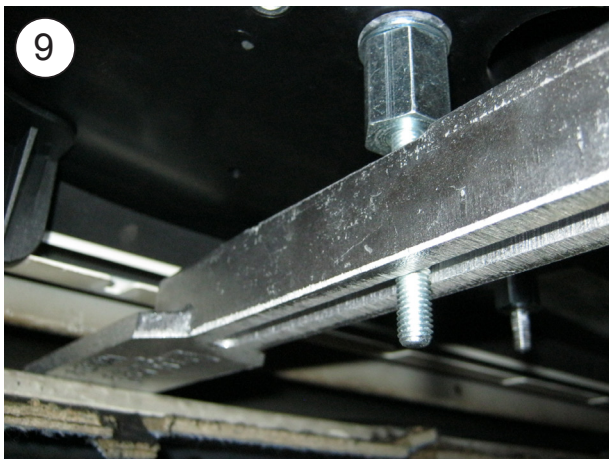



ATTENZIONE: fare attenzione a non schiacciare il cablaggio del tettuccio apribile.



10

Tra la base e il pannello interno di distribuzione dell'aria, collegare (2) scatole a due vie del sensore antigelo (cavi bianchi) e del sensore dell'aria di ritorno (cavi neri), la scatola a 4 vie del ventilatore, (2) cavi di comunicazione e la scatola a 8 vie del cablaggio di connessione con il controllo elettronico.

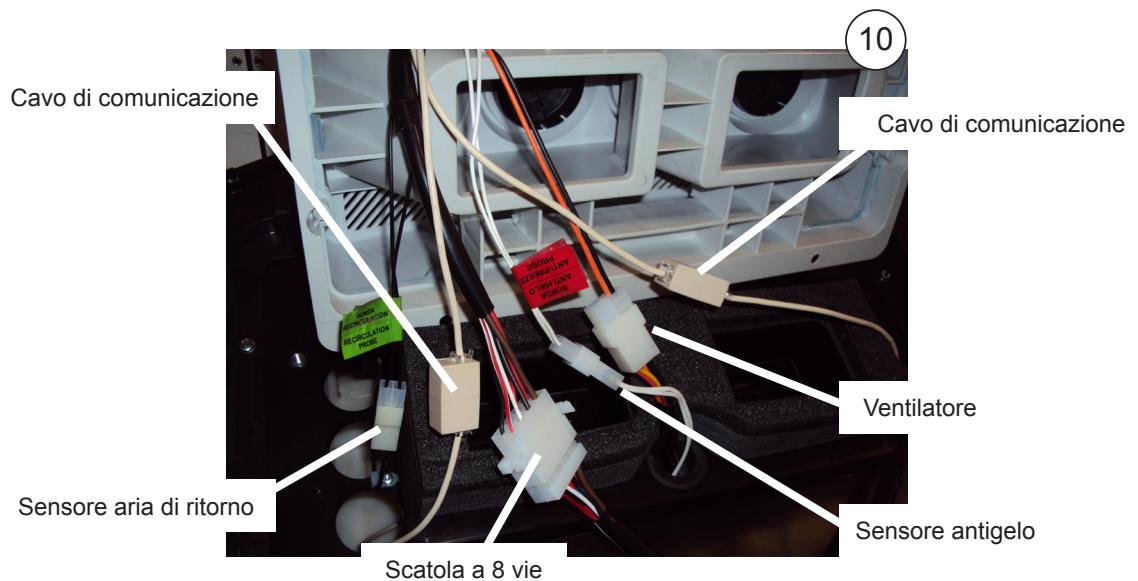

11 Montare il pannello interno di distribuzione dell'aria con (4) perni esagonali tenendo conto della sua posizione a seconda delle misure.

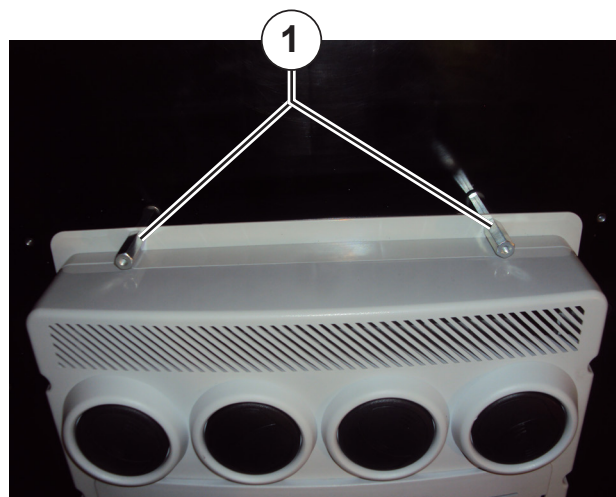

1 Distanziatore 50 mm sulla parte anteriore
2 Distanziatore 43 mm sulla parte posteriore

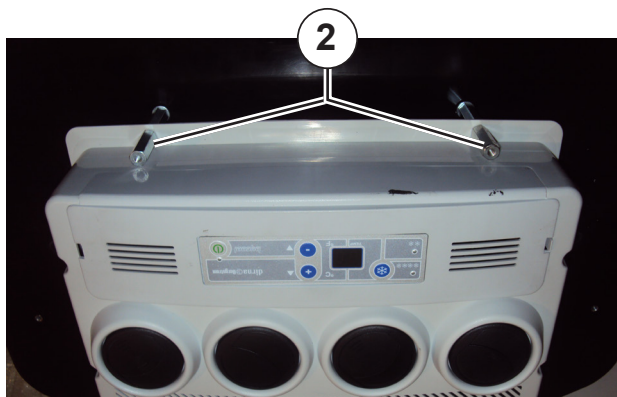

11

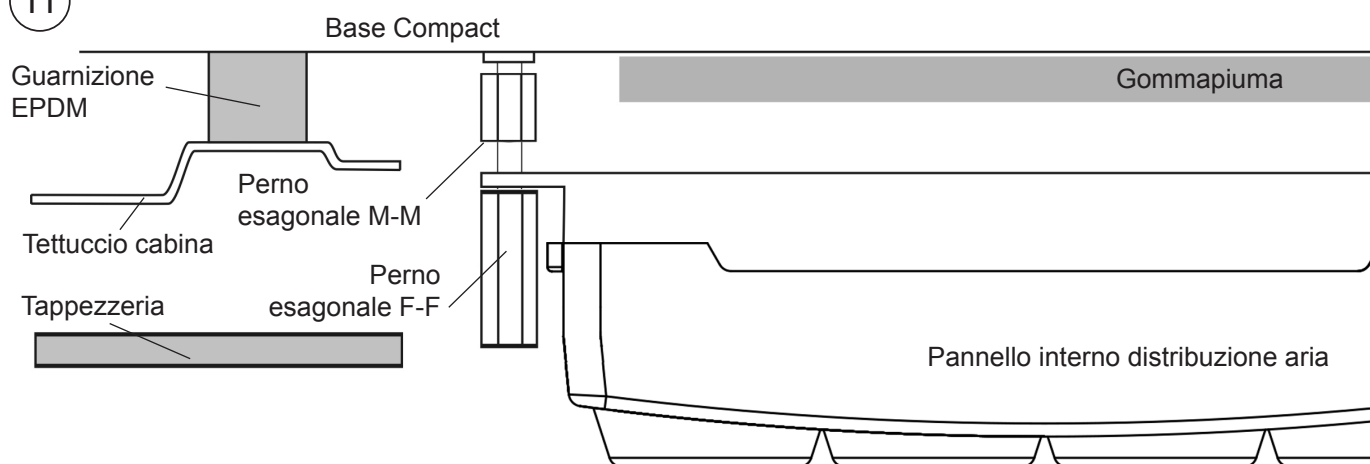

12 Montare la console inserendo (4) viti M6x16 e centrare l'impianto fino a fare coincidere la console con la posizione della tappezzeria in cui era montata quella originale.



- 13** Una volta centrato, smontare la console e stringere i supporti fino a battuta con i perni esagonali.



- 14** Controllare dall'esterno che gli scarichi dell'impianto siano liberi e non vi siano intralci la guarnizione EPDM dell'impianto.

- 15** Rimontare la console con le viti M6x16 stringendo fino a battuta con i perni esagonali.



16 Collegare le luci e incastrarle esercitando pressione sulla console.



ESPLOSO FINO AL FISSAGGIO DEI SUPPORTI DI FISSAGGIO

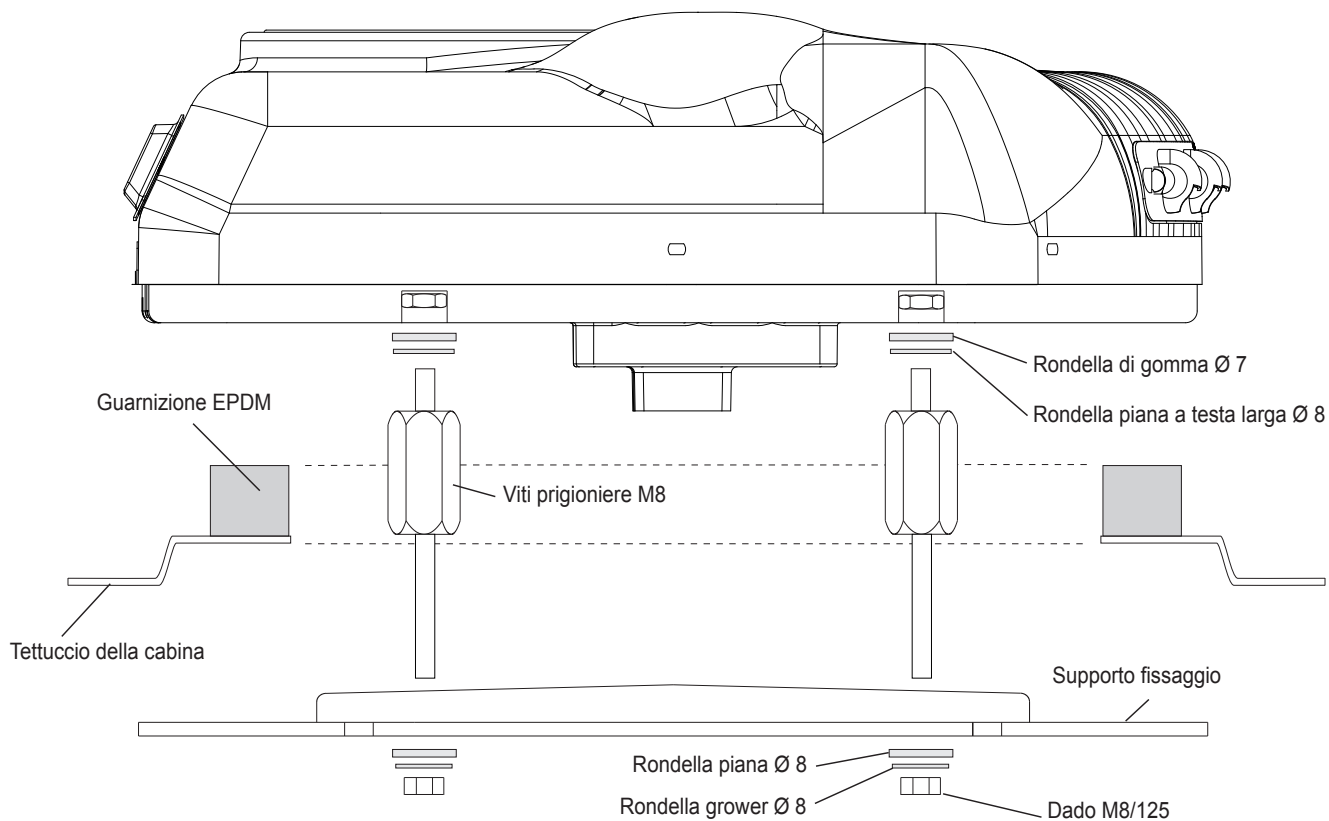

ESPLOSO FINO AL FISSAGGIO DELLA CONSOLLE

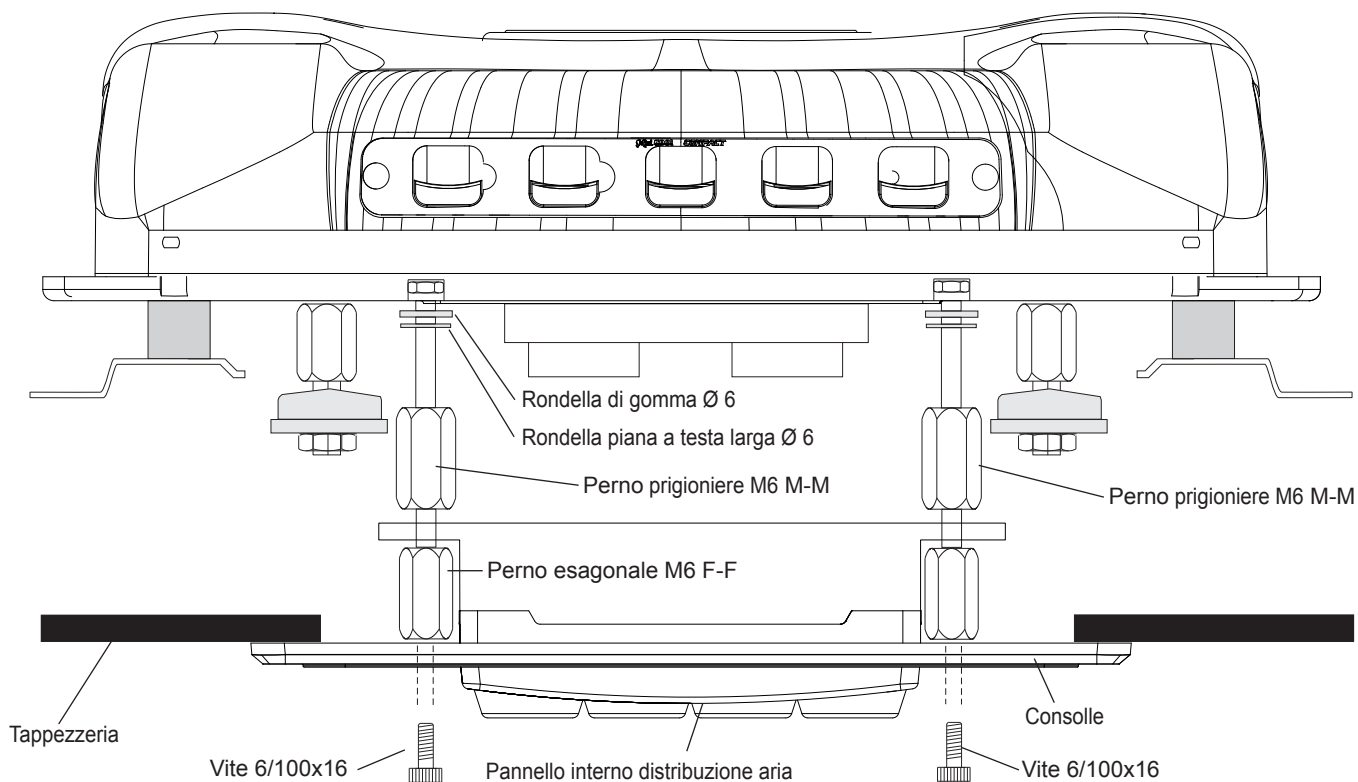

17 Fissare il cablaggio con supporti adesivi e fascette nella cabina, al supporto laterale dello spoiler e al cablaggio originale.

ATTENZIONE: pulire bene la zona prima di incollare i supporti adesivi.

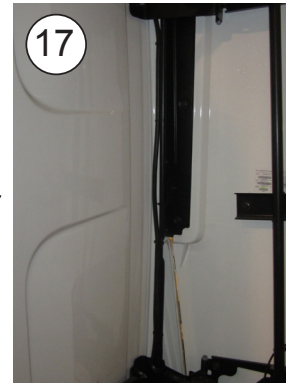

18 Collegare il cablaggio di alimentazione inferiore a quello superiore lasciando la distanza necessaria per evitarne la rottura durante la movimentazione della cabina.

NOTA BENE: Apporre gli adesivi indicanti pericolo sull'attacco del cablaggio e sul dispositivo di sollevamento della cabina per ricordare la necessità di disinserire i morsetti del cablaggio per il ribaltamento della cabina.



19 Smontare la protezione del motore (*), far passare il cablaggio verso le batterie all'interno del telaio e fissare con i cablaggi originali.

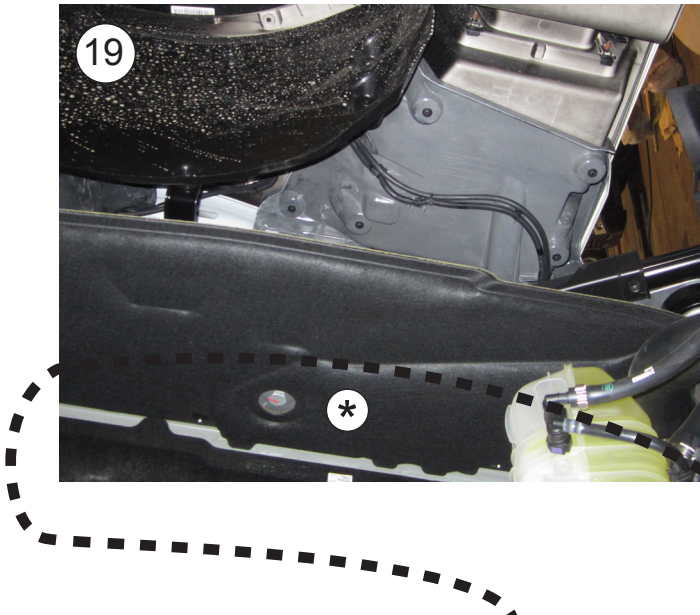

19

*

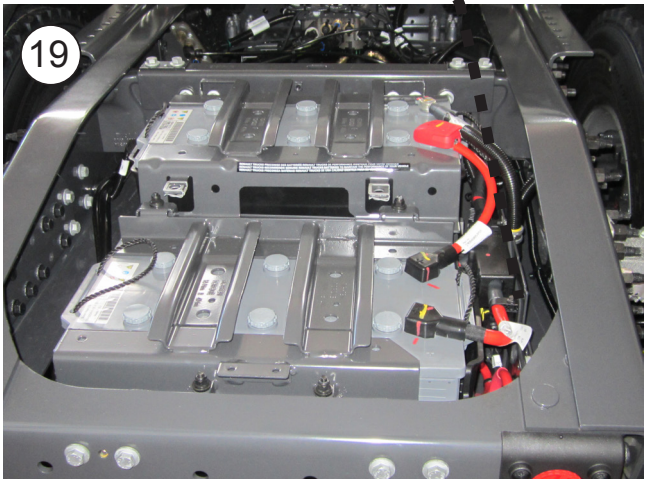

19

20 Smontare la scatola dei fusibili (*) e collegare (+) a quest'ultima e (-) alla presa di massa originale.

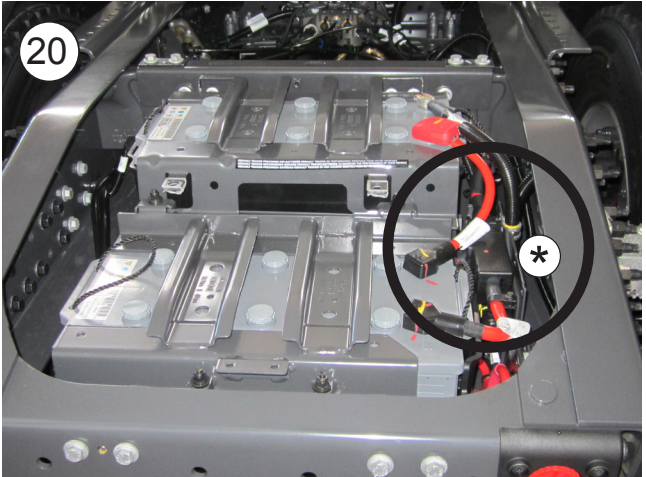

20

*

Schema elettrico

AVVERTENZA IMPORTANTE!

Fare attenzione a non invertire le polarità quando si esegue il collegamento dell'impianto. Altrimenti, non si accende il quadro, l'impianto non funziona e si possono verificare danni irreparabili ai moduli dei compressori.

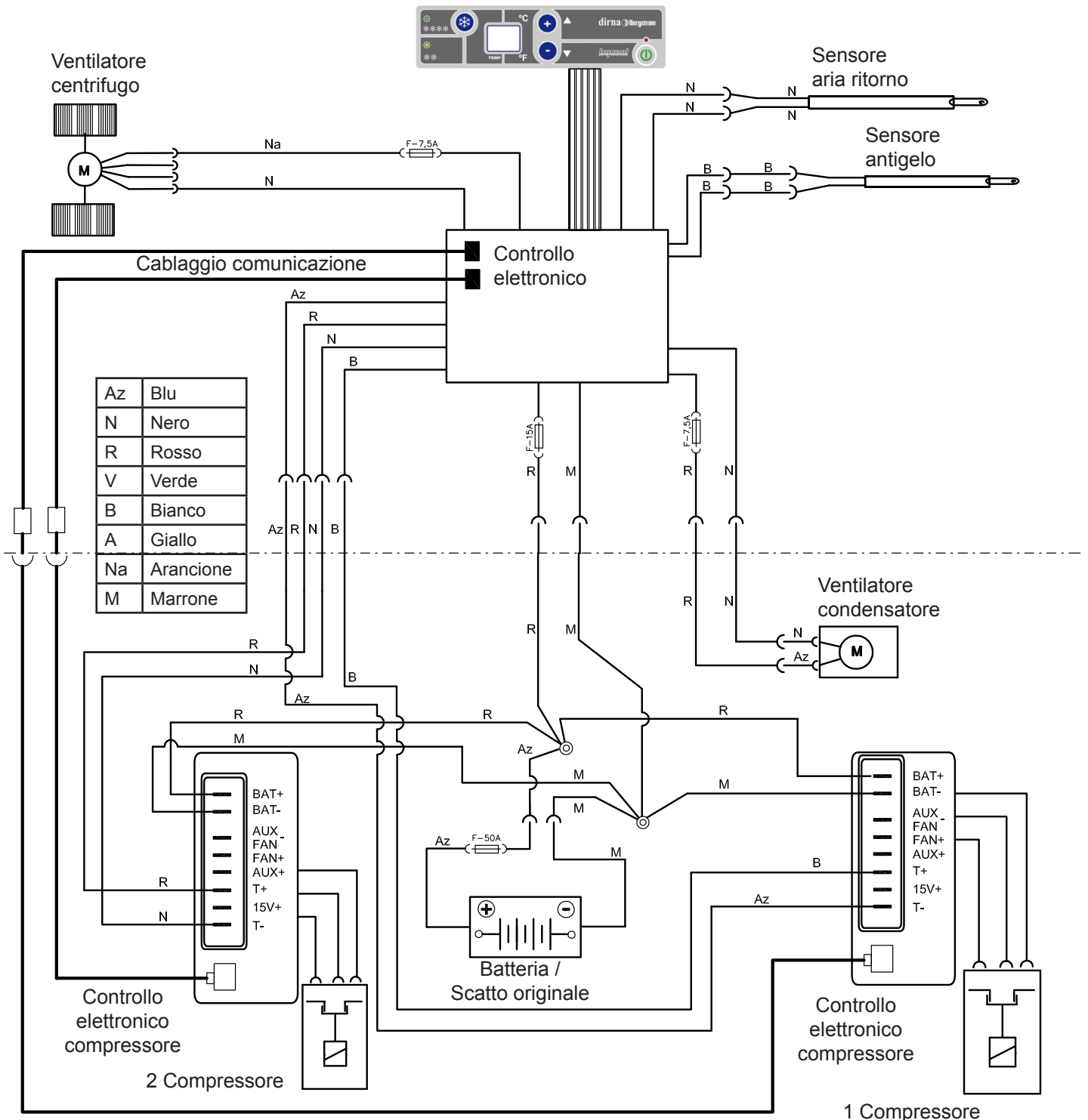

Ed:	07/03/2016
Md:	06/08/2019

b



Francisco Alonso, 6
28806 Alcalá de Henares, Madrid
SPAIN

Contact	Phone	Fax	E-Mail
Sales (Ventas Internacional)	+34 91 8770510	+34 91 8771158	sales@dirna.bergstrominc.com
Comercial Nacional	+34 91 8775841	+34 91 8836321	ventas@dirna.bergstrominc.com
Orders & Deliveries (Logística internacional)	+34 91 8775846	+34 91 8771158	export@dirna.bergstrominc.com
Orders & Deliveries (Logística nacional)	+34 91 8775840	+34 91 8836321	comercial@dirna.bergstrominc.com
Technical Assistance (Internacional)	+49 511 86679681	+49 511 86679710	technicalassistance@dirna.bergstrominc.com
Technical Assistance (Nacional)	+34 91 8775845	+34 91 883 6321	oblanco@dirna.bergstrominc.com

www.dirna.com

	ATENCIÓN:	Dirna Bergstrom se reserva el derecho de efectuar modificaciones en cualquier momento de los datos contenidos en esta publicación, por razones técnicas o comerciales.
	NOTE:	<i>For technical and commercial reasons, Dirna Bergstrom reserves the right to change the data contained in this brochure.</i>
	ATTENTION:	Dirna Bergstrom se réserve le droit d'effectuer à tout moment des modifications des données reprises sur cette publication, pour des raisons techniques ou commerciales.
	HIWEIS:	<i>Dirna Bergstrom behält sich vor, aus technischen oder kaufmännischen Gründen jederzeit Änderungen der Angaben dieser Veröffentlichung vorzunehmen.</i>
	ATTENZIONE:	Dirna Bergstrom si riserva il diritto di effettuare modifiche in qualsiasi momento ai dati contenuti in questa pubblicazione, per motivi tecnici o commerciali.