

bycool!
green line

COMPACT 3.0

DAF



Instrucciones de Montaje

Mounting Instructions

Instructions de Montage

Montageanweisungen

Istruzioni di Montaggio

ES Spanish

EN English

FR French

GE German

IT Italian

Recomendaciones Para el montaje

- Antes de iniciar el montaje leer las instrucciones y seguir las durante el proceso de instalación.
- Usar las herramientas adecuadas para cada operación.

Electricidad

- Desconectar la llave de contacto.
- Desconectar la batería antes de empezar el montaje.
- Asegurar el conexionado de los componentes eléctricos, verificando su correcto encaje.

Atención

Si durante el montaje el equipo se inclina, se deberá esperar un mínimo de 60 minutos desde que el equipo quede en posición horizontal antes de ponerlo en funcionamiento.

Atención

Al instalar el equipo de aire acondicionado en el techo se debe proteger la parte superior de la cabina con un paño ó manta protectora para evitar posibles arañazos. Al instalar **Compact** en el techo hay que tener en cuenta que, normalmente, las cabinas que vienen provistas de escotilla, tienen una estructura suficiente para soportar el peso del equipo. Sin embargo, cuando no ocurra así y sea necesario realizar corte en el techo ó incluso si en el caso de llevar escotilla el material no es lo suficientemente resistente (caso de techo de fibra, plástico, etc...) es el instalador el que debe decidir, **bajo su responsabilidad**, sobre la necesidad de reforzar el techo para evitar posibles deformaciones, roturas, entradas de agua, etc... habilitando los medios para que esto no ocurra.

Herramientas

Juego de Llaves Torx

Juego de Llaves Allen

Llave fija 10, 13, 14

Tijeras

Flexómetro

Documentación incluida

Instrucciones de montaje	1001217173
Manual del usuario	1001218019
Diagnóstico de averías	1001218025
Garantía	220AA10017

Simbología



Fragil





Atención corte!



Riesgo eléctrico

Advertencias

 El personal instalador debe poseer una formación suficiente en Aire Acondicionado de vehículos.

 **dirna Bergstrom, s.l.** queda exenta de responsabilidad si se producen averías que procedan de una inadecuada manipulación ó instalación del equipo, ó por modificaciones y sustituciones efectuadas sin nuestra expresa autorización por escrito.

 **Equipo precargado con gas** refrigerante R-134a. **(No manipular el circuito de gas refrigerante).**

 Véase **procedimiento de garantía** del producto incluido en **Diagnóstico de Averías**.

 Véase **Manual de Usuario** del equipo para el correcto funcionamiento del mando a distancia y del panel de control.

 Al finalizar la instalación se debe entregar al usuario: **Manual del Usuario, Garantía y Diagnóstico de averías.**

 Antes de empezar con el montaje, montar rejilla entrada aire delantera.



1 En el caso de que el vehículo venga con spoiler, solicitar el kit 0911020014.

2 Desmontar tapa escotilla, los elementos de fijación y entregar éstos al cliente (*).

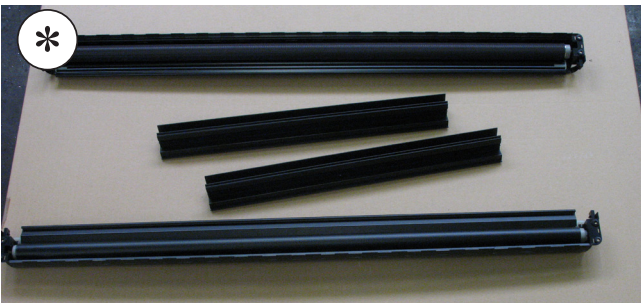

3 Quitar los residuos sobrantes adheridas al techo antes de pegar la junta EPDM.

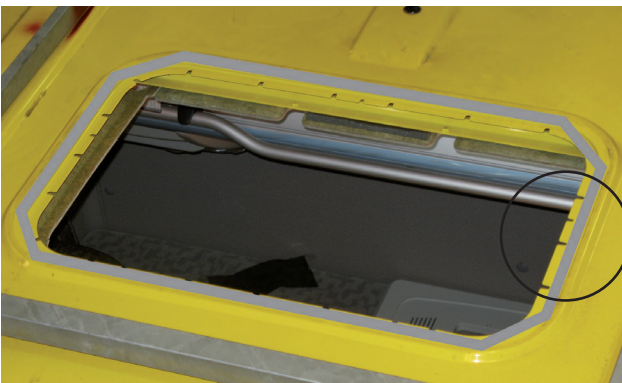

4

En caso de que vehículo tenga spoiler con la barra central, cortar la barra mostrada por líneas de punto para instalar el equipo.



4a

Pegue la junta EPDM alrededor del hueco de escotilla (mirar el detalle para cortar los bordes finales de unión de la junta).

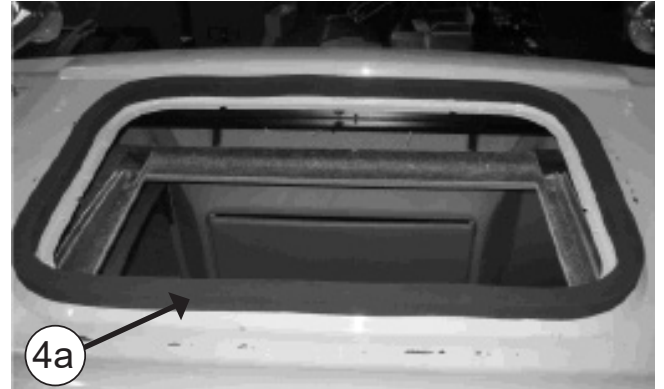

COMO CORTAR LA JUNTA EPDM PARA EVITAR FILTRACIÓN DE AGUA EN LA CABINA

- A- Pegar la junta, manteniendo 100 mm de papel protector por cada lado.
- B- Quitar los dos piezas de papel.
- C- Pegue presionado ambos finales.

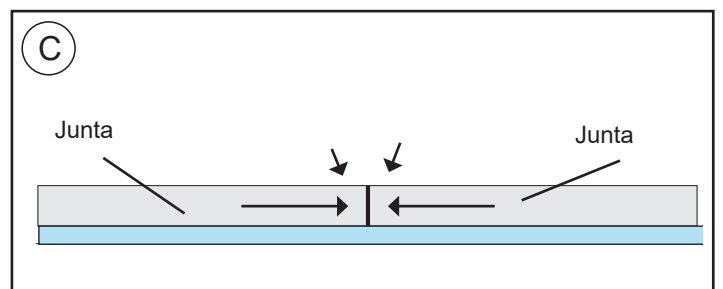
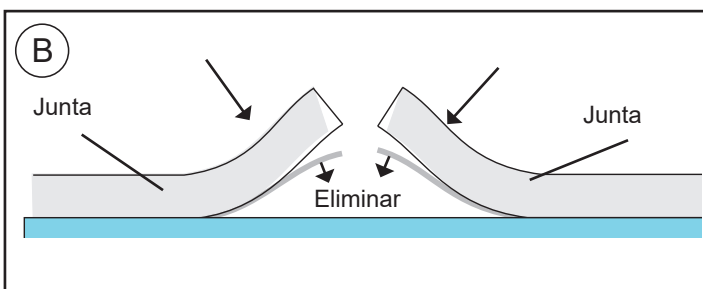
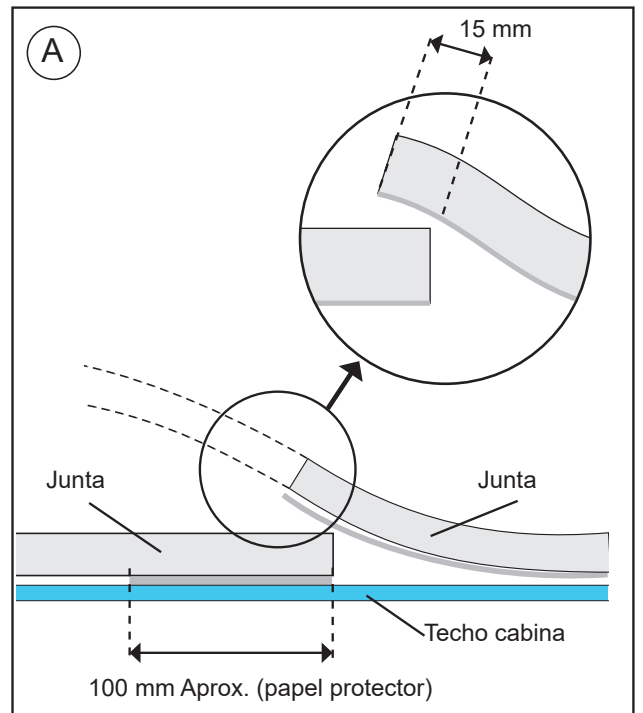

5

EXTERIOR CABINA:

Posicionar el Compact en el hueco de la escotilla.

¡Atención! Al colocar el equipo encima del hueco escotilla, revisar que los tubos de desagüe no queden obstruidos por la junta EPDM.

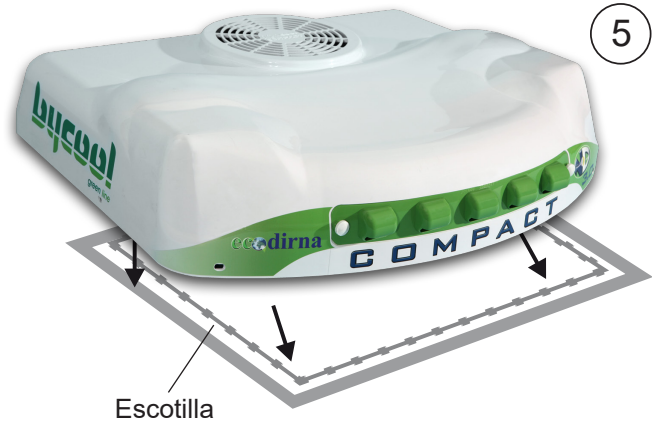

5

6

Colocar canalizador gomaespuma quedando la parte más blanda en la base del equipo.

Atención: Dependiendo de la cabina, es posible que sea necesario usar los (2) canalizadores suministrados para que el panel de distribución de aire quede totalmente ajustado con ellos.



6

7

INTERIOR CABINA:

Roscar 5 mm aproximadamente (4) espárragos 8/125x100-70 ó 120, la medida se elegirá tras presentar los soportes de sujeción y teniendo en cuenta que los espárragos deben sobresalir de los mismos por la parte inferior unos 20 mm.

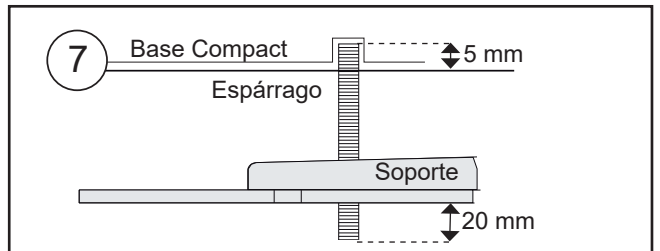

8

Colocar (1) arandela Ø 7 de goma, (1) arandela plana Ø 8 ala ancha, (2) tuerca M8 y (1) arandela plana Ø 8 ala ancha, en cada uno de los espárragos anteriores; siguiendo dicho orden.

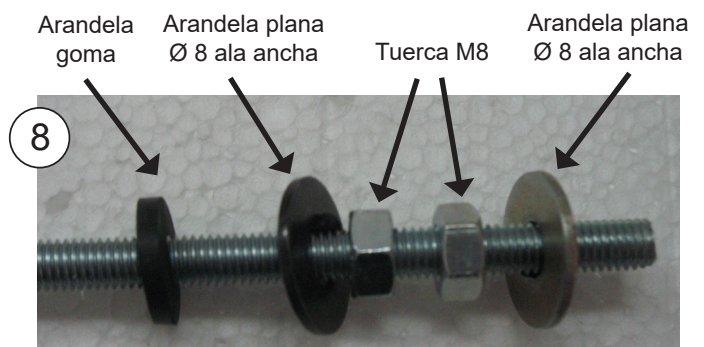

8a Colocar (2) soportes sujeción, con (1) arandela y (1) tuerca autoblocante M8, **sin llegar a apretar.**

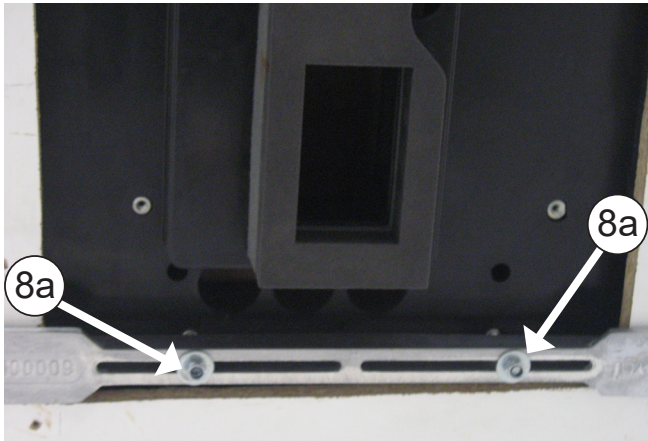

9 Roscar 10 mm (4) espárragos M6 x 80, donde se indica, según distancia (D) del esquema del punto 16.

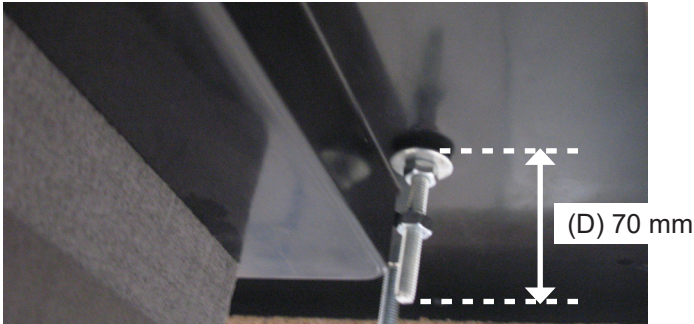
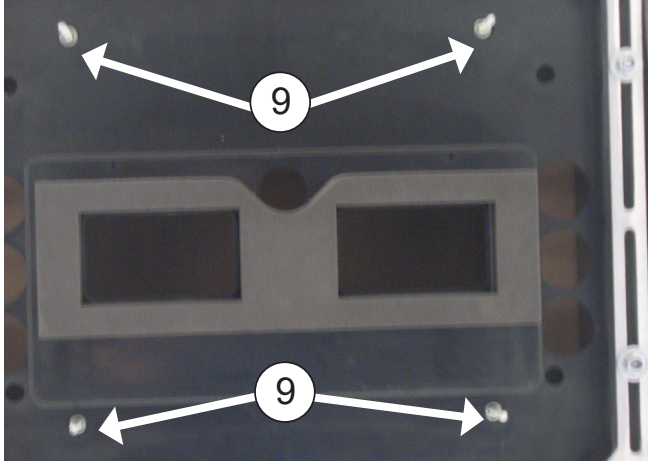

10 Colocar (1) arandela Ø6 de goma, (1) arandela plana Ø6 ala ancha y (1) tuerca M6, sobre cada uno de los espárragos de M6. A continuación apretar la tuerca hasta que la arandela de goma quede un poco oprimida.

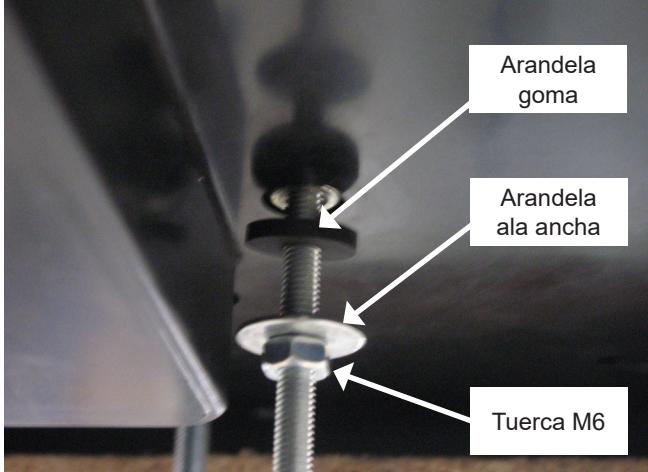

10a Colocar (1) tuerca M6 **sin apretar** en cada espárrago .

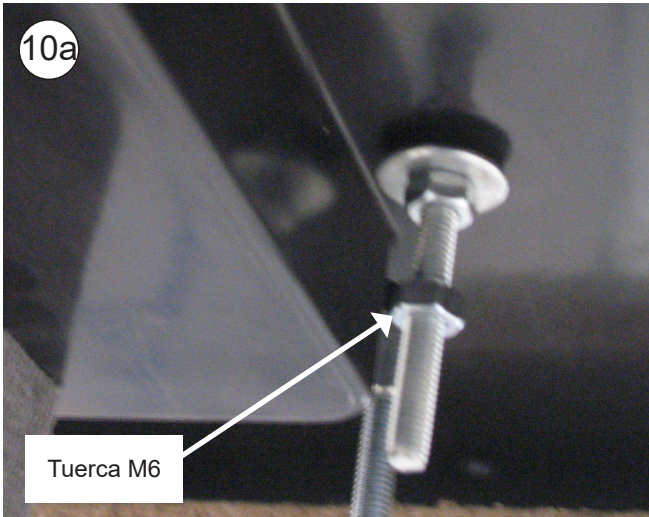

10b Entre la base y el panel interior de distribución de aire, conectar (2) cajas de dos vías de sensor antihielo (cables blancos) y sensor aire de retorno (cables negros), caja de 4 vías del soplador, (2) cables de comunicación y caja de 8 vías de cableado a conexión con control electrónico.

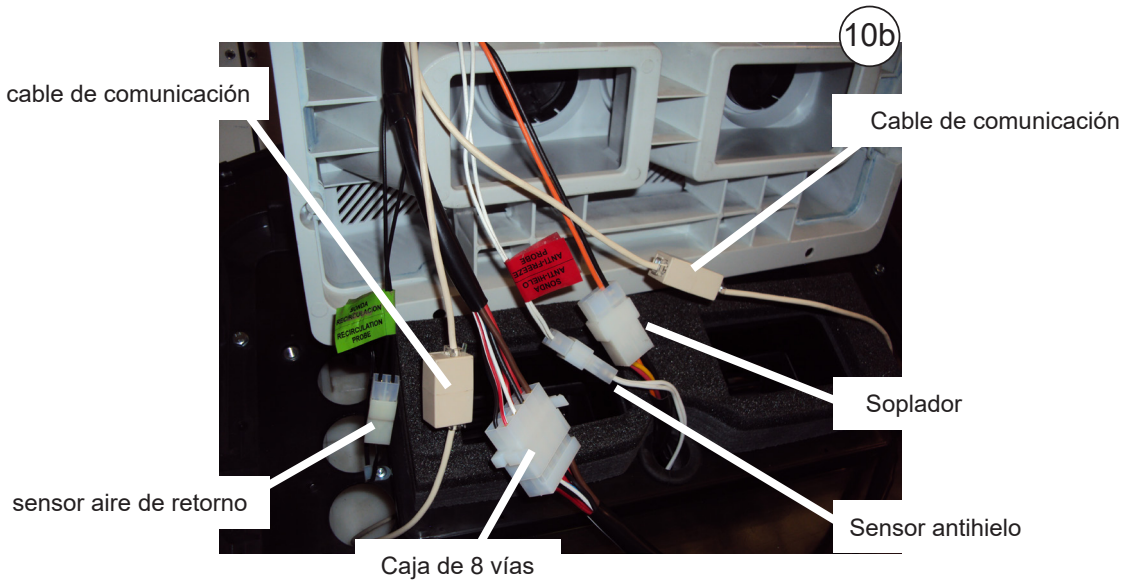

11

Colocar el panel interior de distribución de aire en los espárragos anteriores con (1) arandela M6 ala ancha y (1) tuerca M6 en cada espárrago. Apretar tuercas hasta que el canalizador del panel interior de distribución de aire haga tope en goma espuma superior del equipo.

Importante: El canalizador del panel interior de distribución de aire debe hacer tope contra la goma espuma superior del equipo para evitar fugas de aire.

Tener la precaución de no pillar los cableados entre el canalizador y la gomaespuma colocada en la base del equipo.

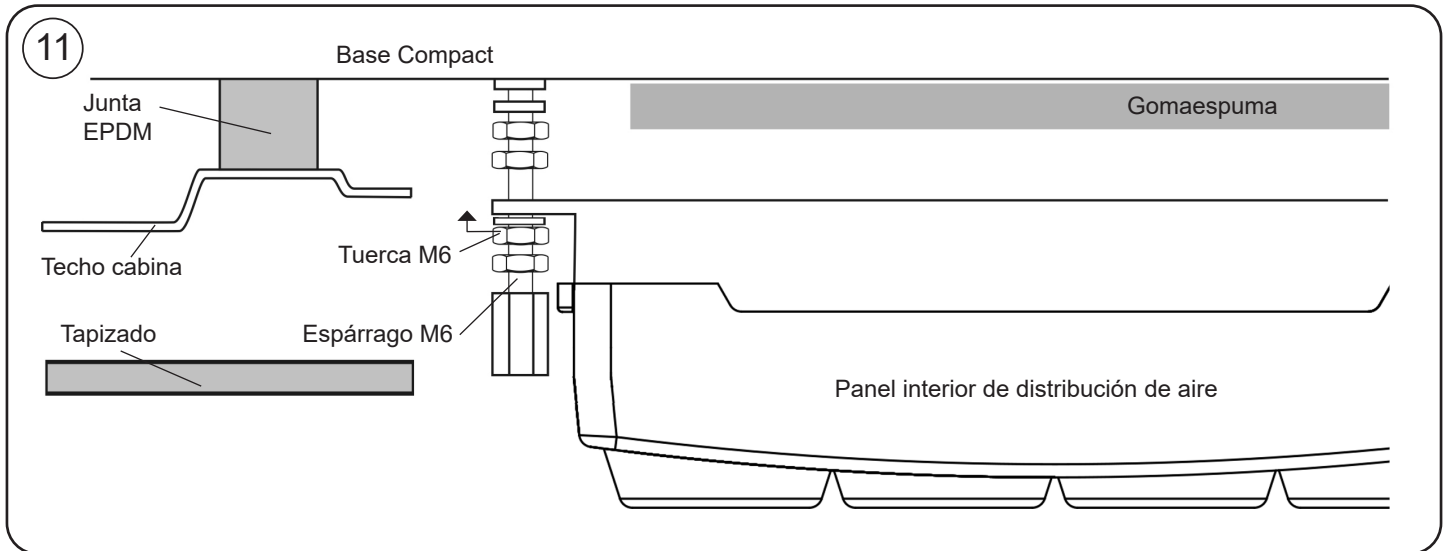

12

Apretar tuerca del punto 10a hasta hacer tope con la parte superior del panel interior de distribución de aire.

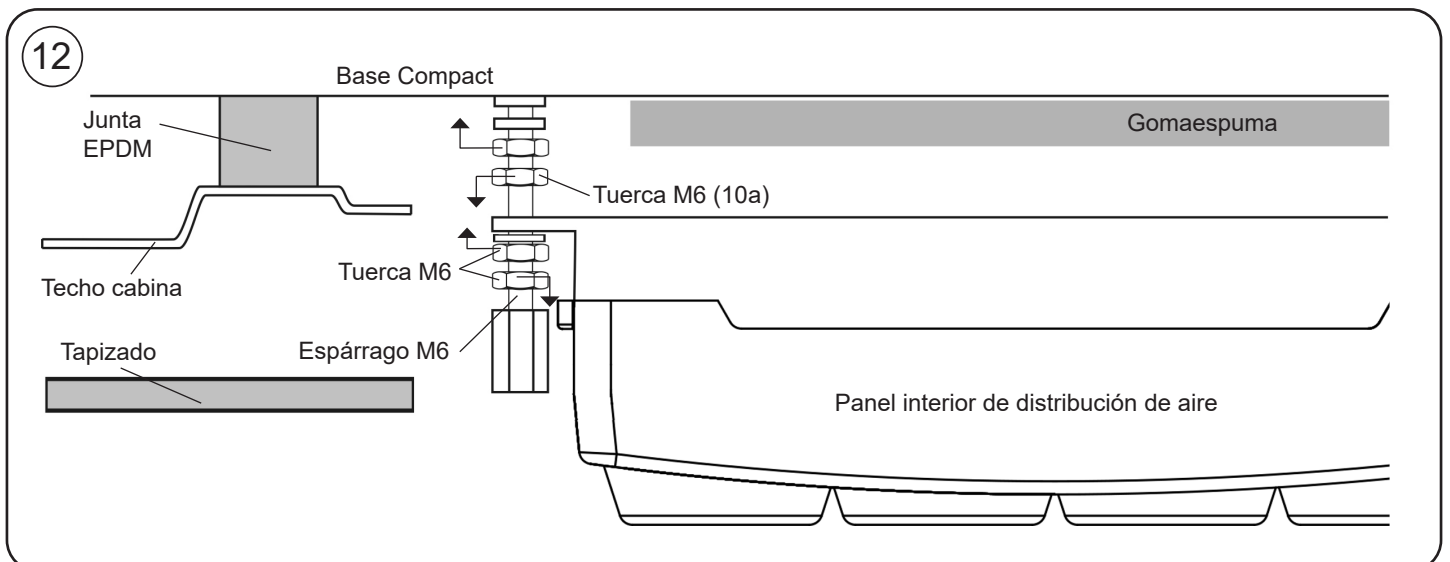

13 Presentar consola y centrar el equipo en el sitio más conveniente del techo de la cabina. Una vez centrado quitar consola.

14 Fijar los soportes de sujeción apretando las tuercas hasta el apriete de la junta de EPDM exterior (**Punto 4a**) del equipo entre 3 y 6mm; la junta debe quedar con un espesor entre 19 y 22 mm.
Importante: Para evitar posibles filtraciones de agua al interior de la cabina se debe asegurar el apriete de la junta EPDM con la base del Compact tal y como se indica en el **esquema**.

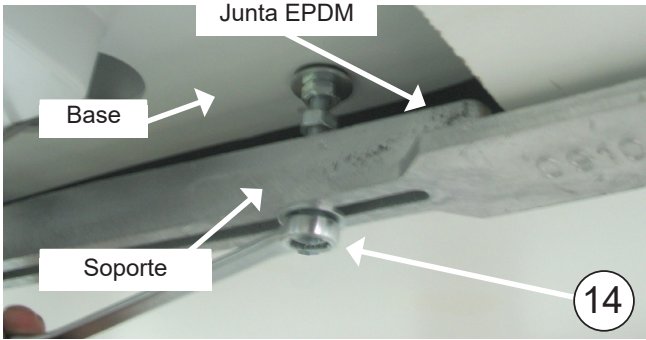
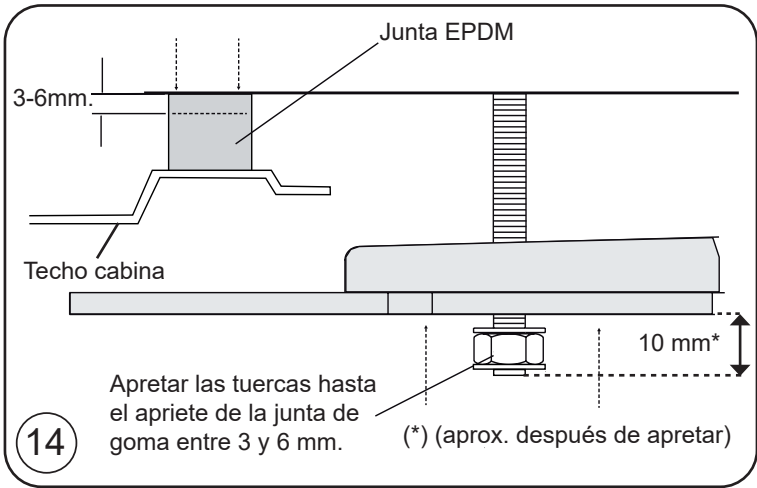

15 Apretar (4) tuercas M8 al soporte y (4) a la base del Compact.



16

Colocar tuerca M6 (A) tras la tuerca de fijación del panel interior de distribución de aire en cada espárrago. Colocar exágonos M6 roscandolo hasta que quede 1 mm por encima del tapizado en vehículos con cabina Super Space Cab y 10 mm por debajo del tapizado en el resto de vehículos. Desenroscar tuercas M6 (A) de este punto hasta que haga tope con los hexágonos y apretar contra estos.

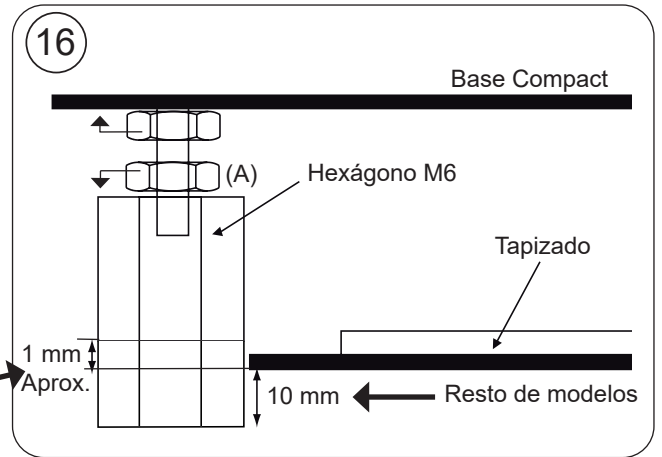

Resto de cabinas



Cabina Super Space Cab

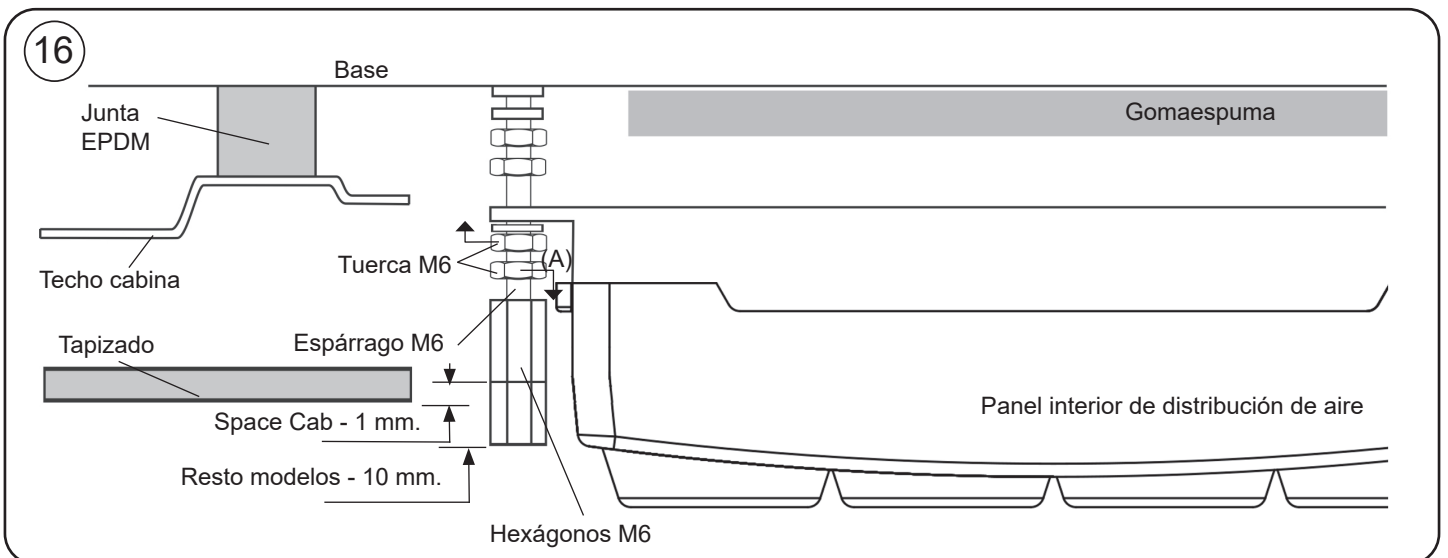

17 Colocar la consola con (4) tornillos M6/100x15 allen.



18 Cubrir los (4) tornillos M6/100x15 allen con los embellecedores redondos de M6 de plástico.



Vista explosionada hasta la fijación de los soportes

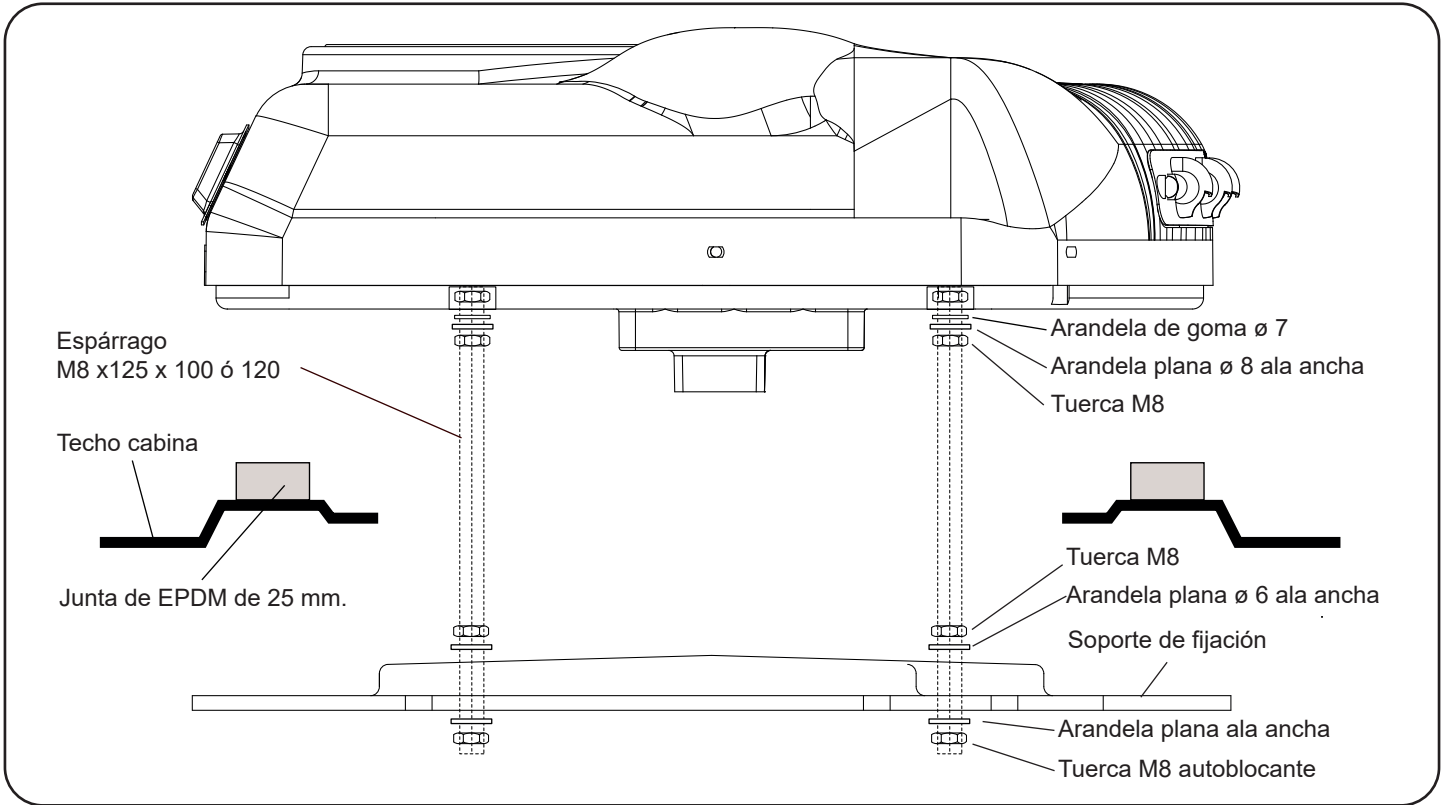

Vista explosionada hasta la fijación de las consolas

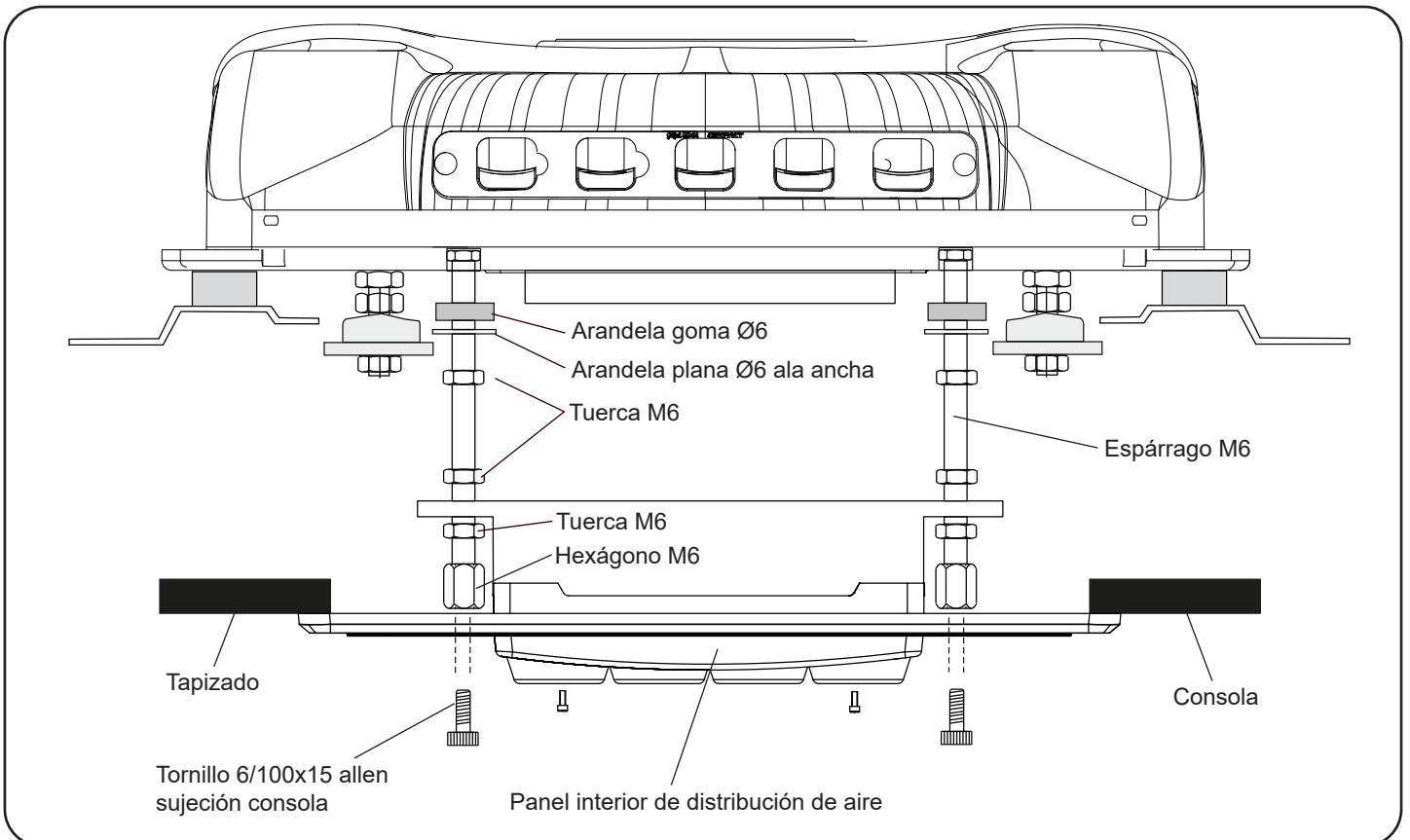

Instrucciones detalladas sobre la instalación del cableado de alimentación

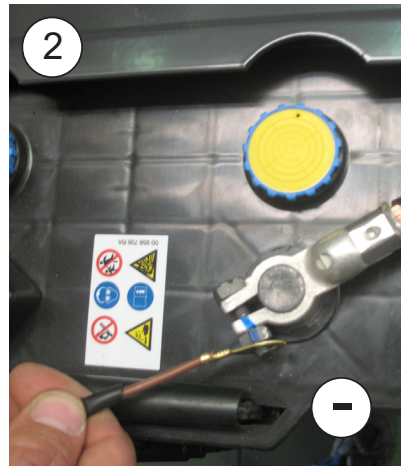
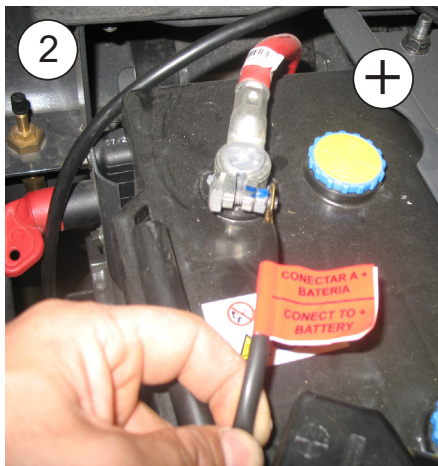
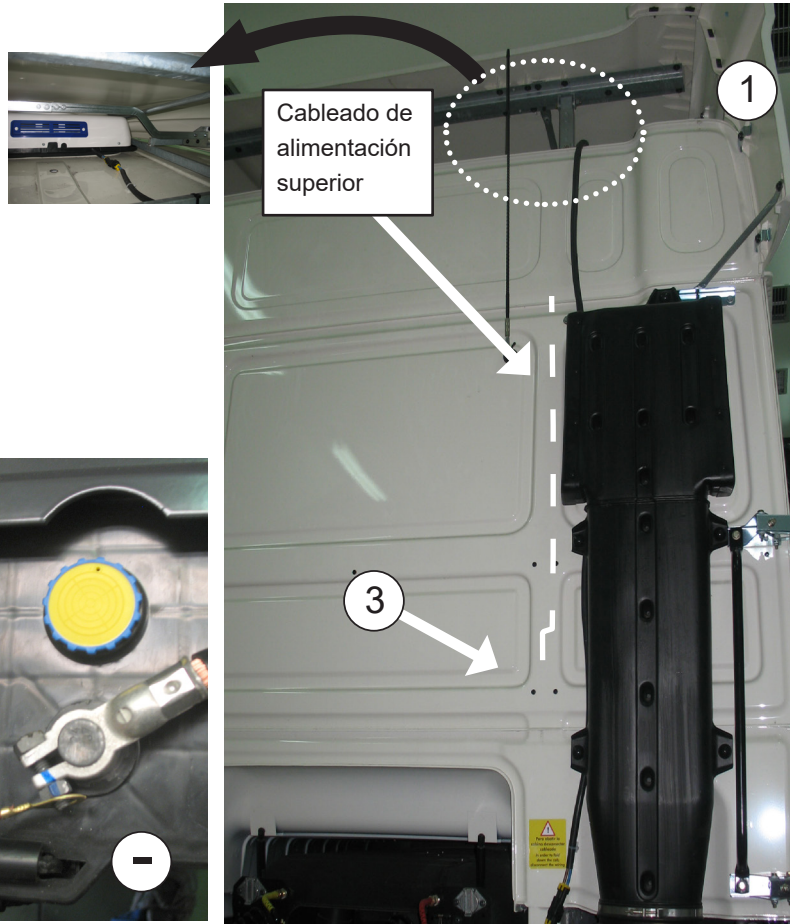
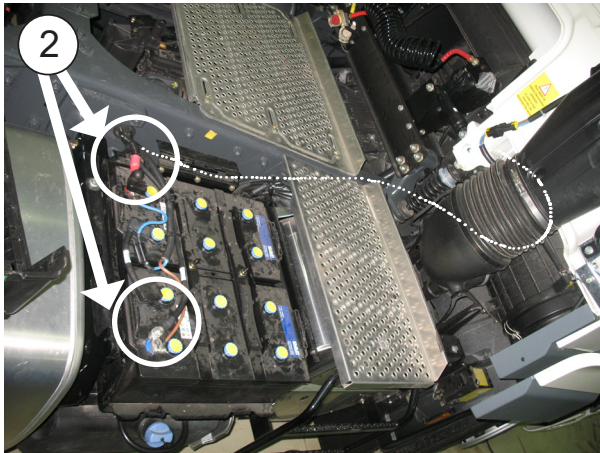

- 1- Conectar el cable de alimentación superior en la parte trasera del equipo y llevarlo por la parte posterior de la cabina pegando los soportes de plástico y fijándolo c/bridas.
- 2- Conectar cable de alimentación inferior en batería, llevándolo por el paso de cableados original, sujeto c/bridas, hacia la parte posterior de la cabina, para conectar con el cable de alimentación superior ; ; **AL CONECTAR LOS CABLEADOS ,DEJAR LA DISTANCIA ADECUADA ,PARA EVITAR SU ROTURA POR LOS MOVIMIENTOS DE LA CABINA!!**

IMPORTANTE: Debido al complejo sistema de regulación electrónica del equipo, la toma de corriente debe realizarse directamente a la batería del vehículo.

IMPORTANTE: Para la puesta en marcha consultar el Manual del Usuario.



- 3- Colocar adhesivos de peligro en unión de cableado y en dispositivo de elevación de cabina.



Esquema eléctrico

¡AVISO IMPORTANTE!

Precaución de no invertir las polaridades al conectar la alimentación en el equipo. Si esto sucediera la placa no se enciende y el equipo no funciona y se producirán daños irreparables en los módulos de los compresores.

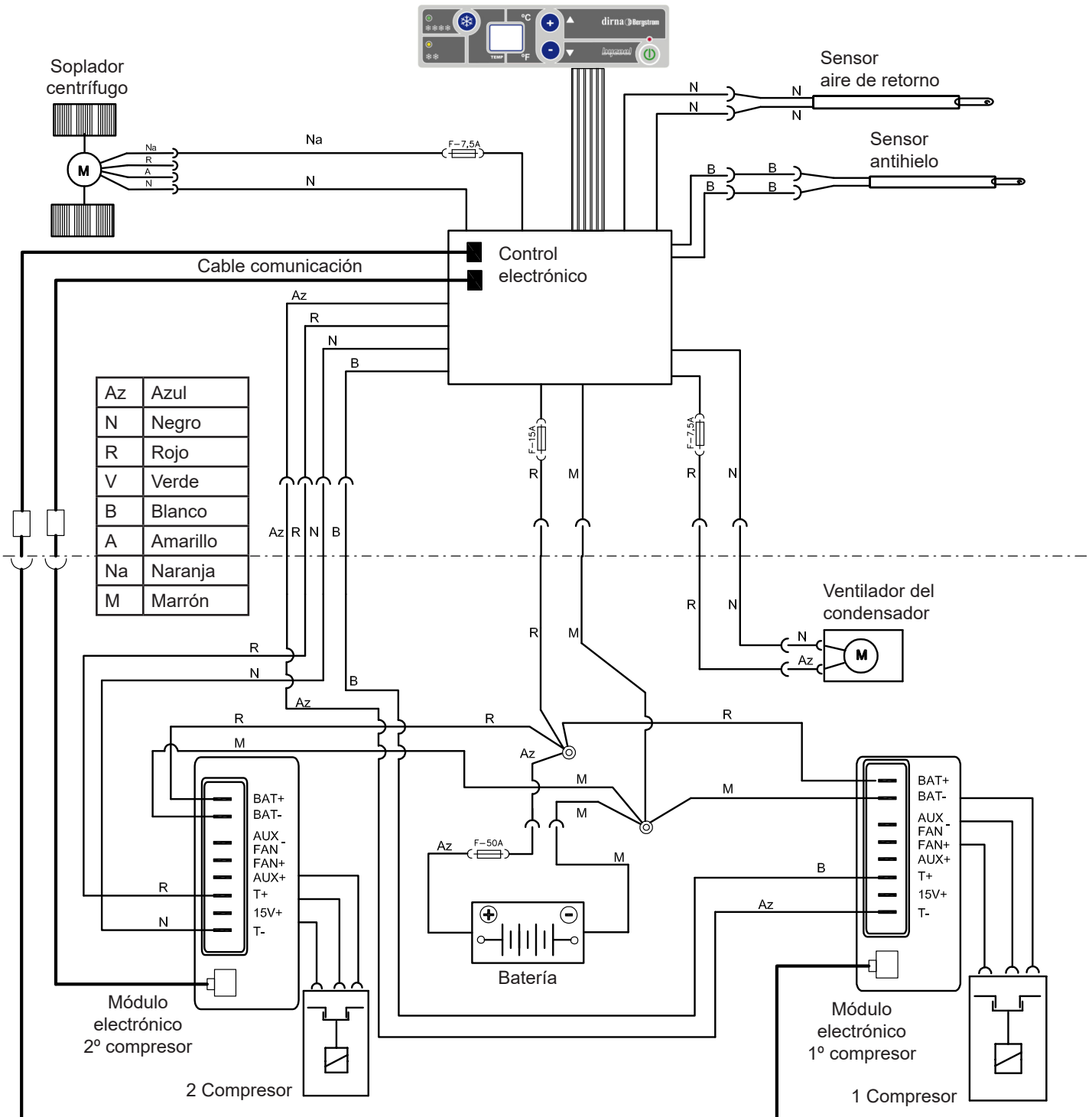

A series of horizontal dotted lines for writing, spanning the width of the page.

Assembly Recommendations

- Before starting assembly, please read instructions and follow them during installation process.
- Use the adequate tools for each operation.

Electricity

- Disconnect ignition key.
- Disconnect battery before starting assembly.
- Make sure electric components are securely connected, checking their correct fitting.

 **Warning**

If the unit slants during assembly, wait for at least 60 minutes with the unit in horizontal position before starting it up.

 **Warning**

When installing air conditioning equipment on roof, the upper cabin part must be protected with a cloth or a protective blanket to avoid possible scratches. When installing **Compact** on roof, take into account that, normally, cabins equipped with a hatch have a strong enough structure to hold equipment weight. However, if it is not the case and it is necessary to carry out a cut in the roof or, although it has a hatch, the material is not resistant enough (*if roof is made of fibre, plastic, etc...*), it is the installer who will have to decide, under his responsibility, if it is necessary to reinforce the roof to avoid possible deformations, breaks, water entries, etc., habilitating the means required to stop it from occurring.



Tools

- Torx wrenches set
- Allen wrenches set
- Open-jawed spanner 10, 13, 14
- Scissors
- Flexo-meter







Documentation included

Mounting instructions	1001217173
User's guide	1001218019
Troubleshooting	1001218025
Warranty	220AA10017

Symbology

-  Fragile
-  Beware of cuts!
-  Electrical hazard

 **Warnings**

-  The installing personnel must have a sufficient training in vehicles air conditioning.
-  **dirna Bergstrom, s.l.** shall not be responsible for breakdowns or damages coming from an inadequate handling or installation of the equipment or from modifications and substitutions carried out without our express and written authorisation.
-  **Equipment pre-charged with refrigerating gas, R-134a. (Do not handle refrigerating gas circuit).**
-  Please see product **warranty procedure** included in **Troubleshooting**.
-  Please see equipment **User's Guide** for its correct functioning of the remote control and control panel.
-  Once installation is finished, the following documents must be handed over to the user: **User's Guide, Warranty** and **Troubleshooting**.

 Mount the front air input grille before starting assembly.



1 In case the vehicle avenges with spoiler, to request the kit 09111020014.

2 Dismantle sun hatch, fastening elements and hand over to client (*).

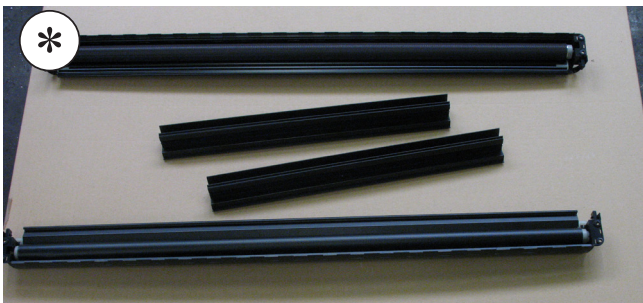

3 Remove residual glue substance of the roof upper surface before glueing EPDM gasket.

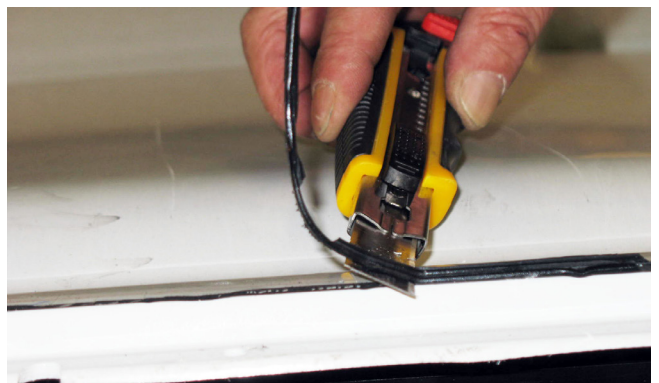
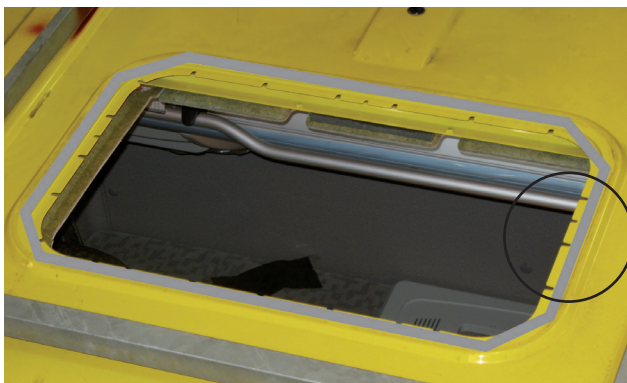

4

In case vehicle has a spoiler with central bar, cut the bar shown by dot lines in order to install equipment.



4a

Glue EPDM gasket around hatch hole (see detail for cutting end join edges).

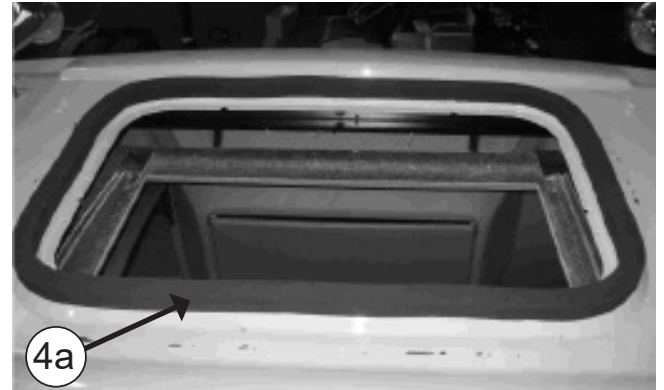

HOW TO CUT EPDM GASKET TO AVOID WATER FILTRATION INTO THE CABIN

- A- Glue gasket, keeping 100 mm of protection paper at each side.
- B- Remove the two pieces of paper.
- C- Glue by pressing both ends.

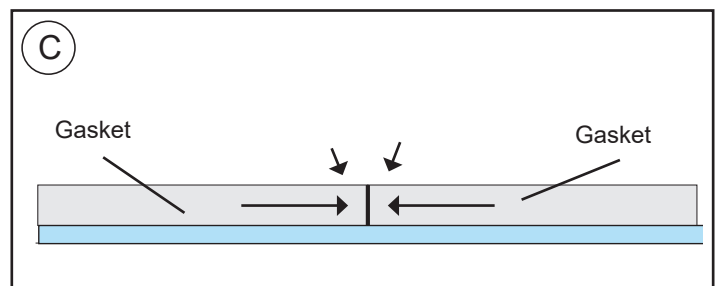
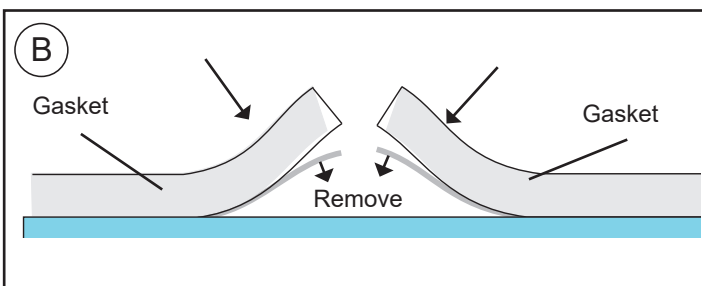
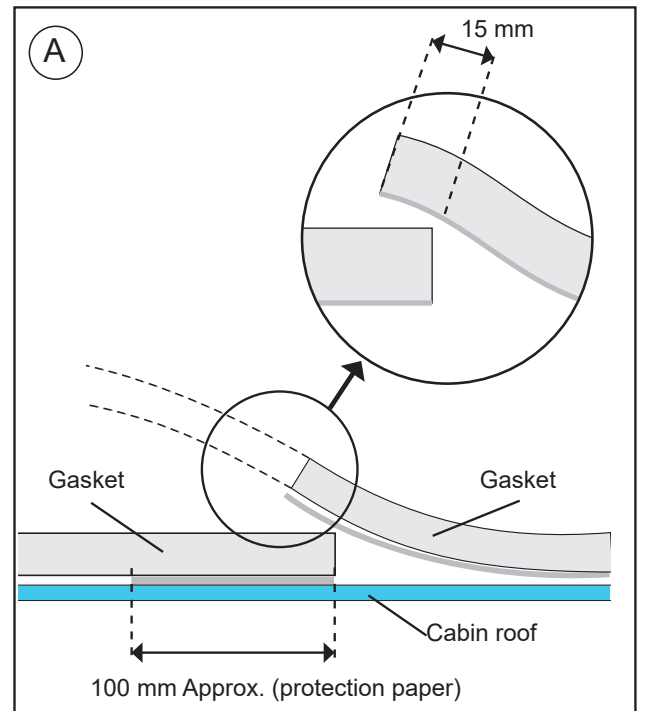

5 **OUTSIDE CABIN:**
Position **Compact** in sun hatch hole.

Caution! When positioning the unit above the hatch gap, check that the wastewater run-offs are not blocked by the EPDM seal.

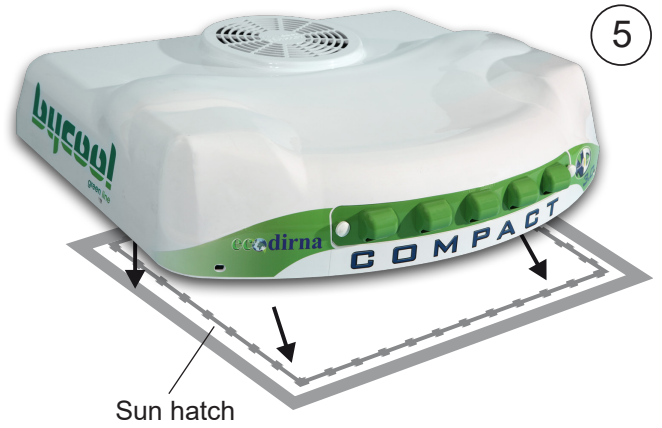

6 Position the foam rubber, ensuring the softest part is placed on the base of the unit.

Caution: Depending on the cabin, it may be necessary to use the (2) supplied ducts in order for the distribution panel to be completely adjusted.



7 **INSIDE CABIN:**
Screw about 5 mm (4) 8/125x70,100 or 120 mm studs, the exact measure is chosen after the fastening supports have been presented and taking into account that studs must stick out of lower part about 20 mm.

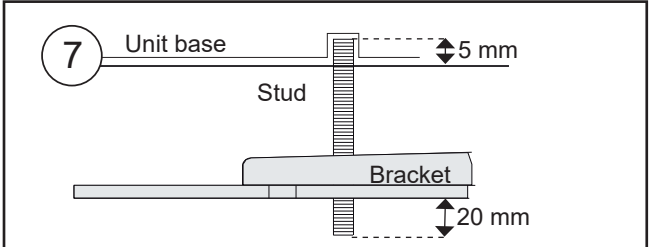

8 Following this order:

- plane rubber wash
- plane rubber wash wide wing diameter 8
- nut M8
- plane washer diameter 8 wide wing

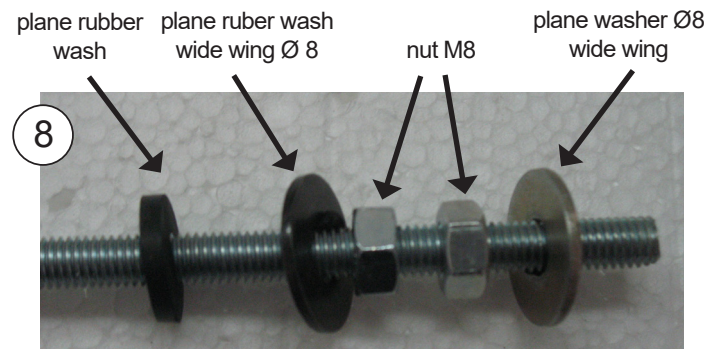

8a Place (2) fastening supports, with (1) washer and (1) M8 self-blocking nut, **without tightening**.

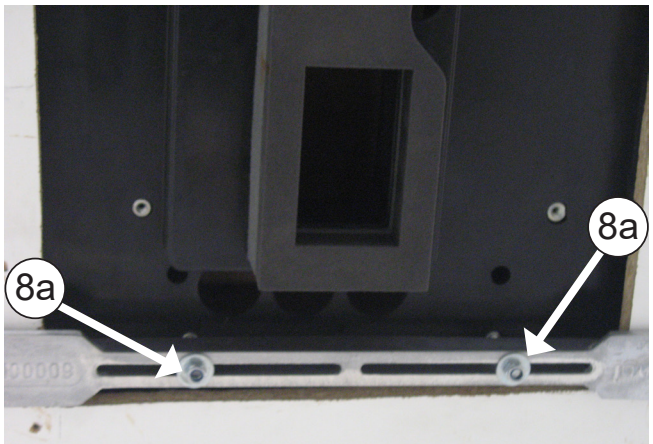

9 Screw 10 mm deep (4) M6 x 80 studs, where indicated distance (D) in figure point 16.

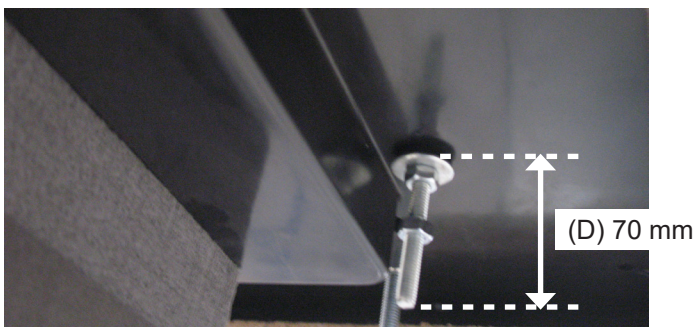
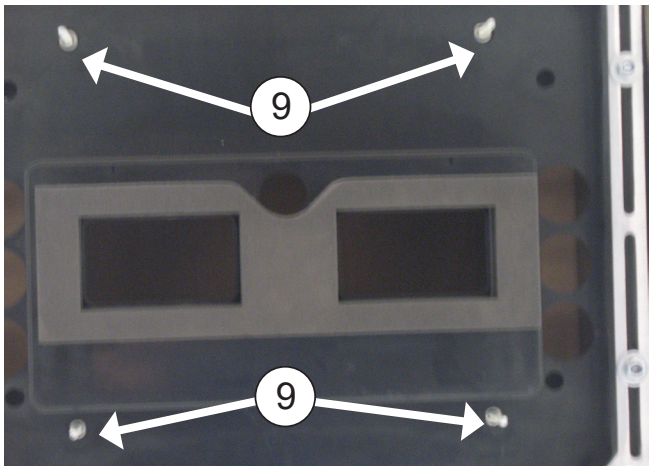

10 To place (1) rubber washer diameter 6 (1), plane washer diameter 6 wide wing and (1) nut M6, over each of the spigots of M6. After, to tight the nut til the rubber washer remain a little tight.

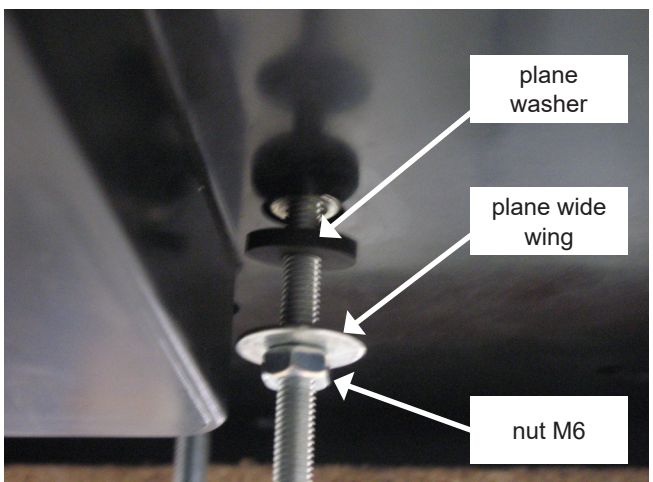

10a Place (2) fastening supports, with (1) washer and (1) M6 nut, **without tightening**.

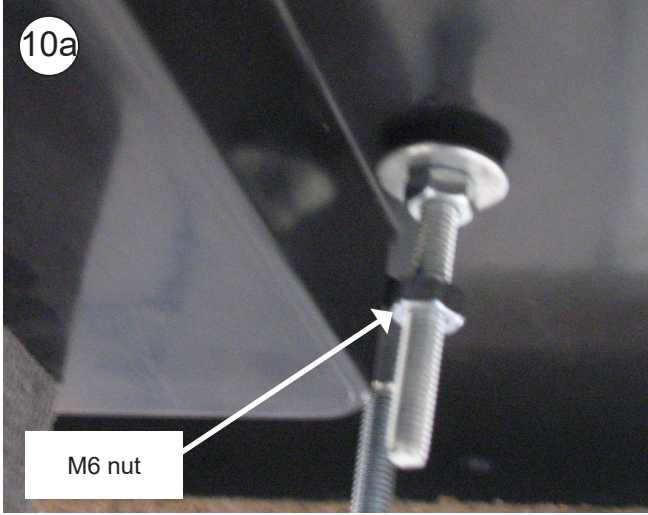

10b Between the base and the interior air distribution panel, connect (2) two-way boxes of the anti-freeze sensor (white cables) and the return air sensor (black cables), 4-way box of the blower, (2) communication cables and 8-way box of the electronic control connection cables.

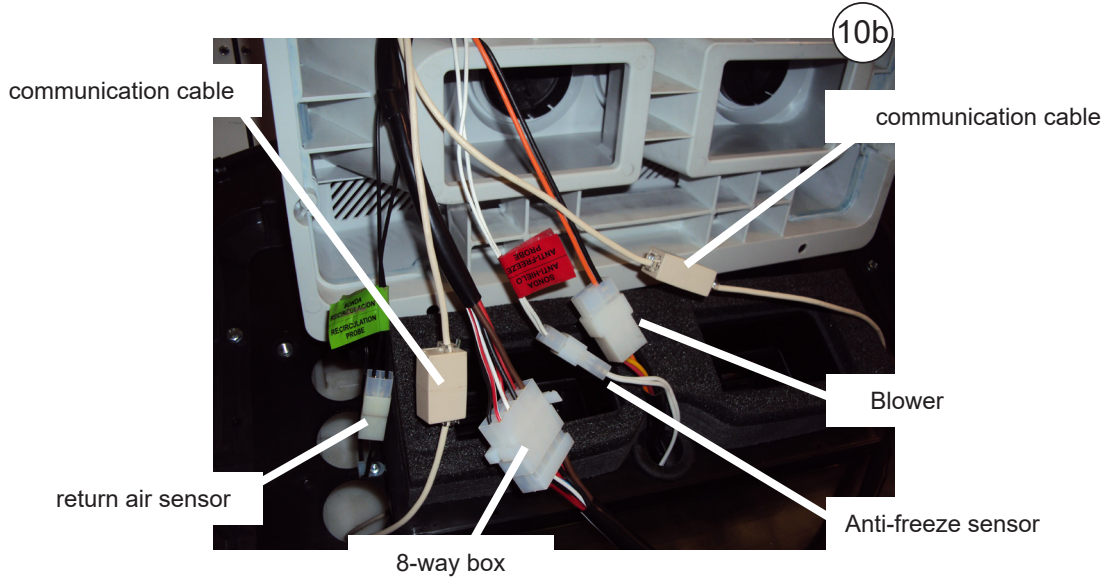

11

Position the interior air distribution panel on the front studs with (1) M6 wide-flanged washer and (1) M6 nut on each stud. Tighten the nuts until the interior air distribution panel duct comes up against the unit's top foam.

Important: The interior air distribution panel duct must come up against the unit's upper foam in order to prevent any leakages of air.

Take care to ensure the cables do not become trapped between the duct and the foam in the base of the unit.

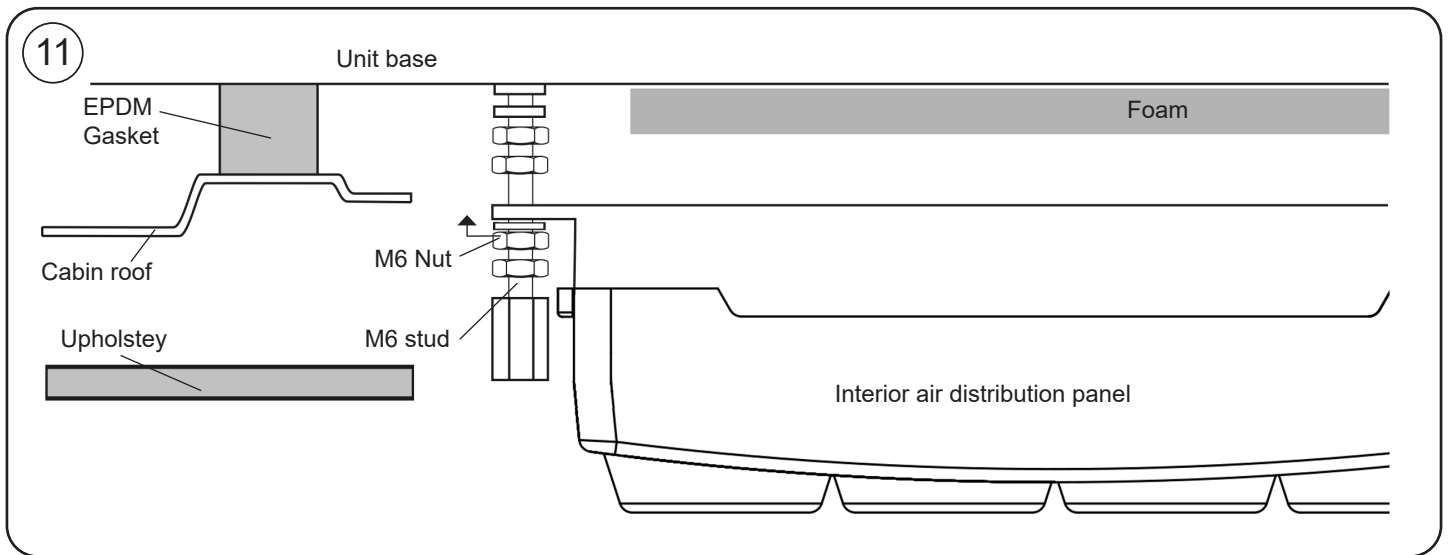

12

Tighten the nut in point 10a until it comes up against the top part of the interior air distribution panel.

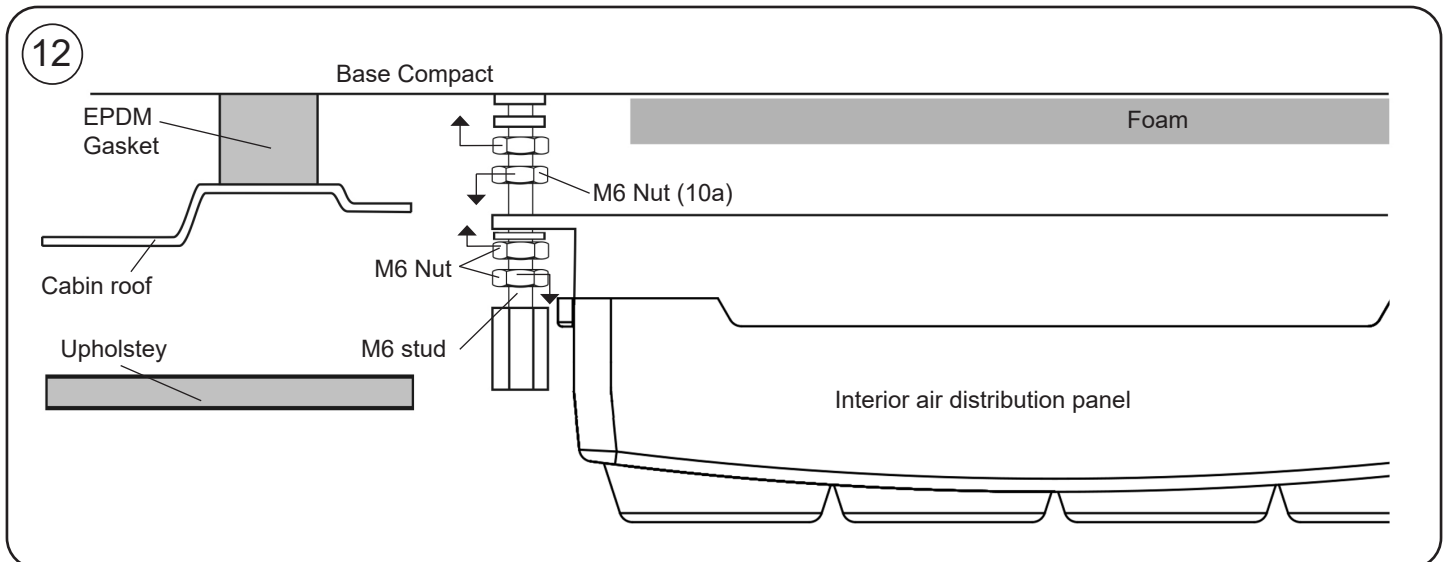

13 Place console and centre equipment in the most convenient place of cabin roof. Once centred, remove console for later installation.

14 Fasten supports tightening nuts until outside EPDM joint (**Point 4a**) of equipment is compressed, between 3 and 6 mm; joint EPDM must stay with a thickness of 19 and 22 mm.

Important: To avoid water from filtering inside cabin, check EPDM joint tightening with Compact base, as indicated on **diagram**.

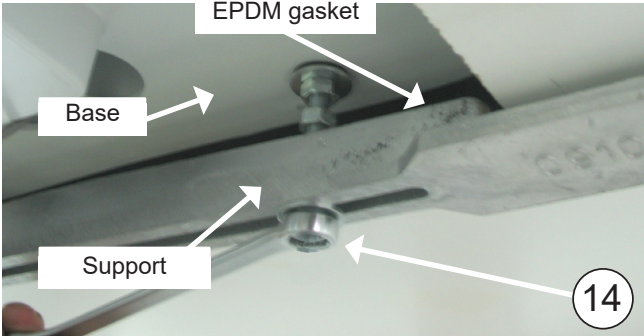
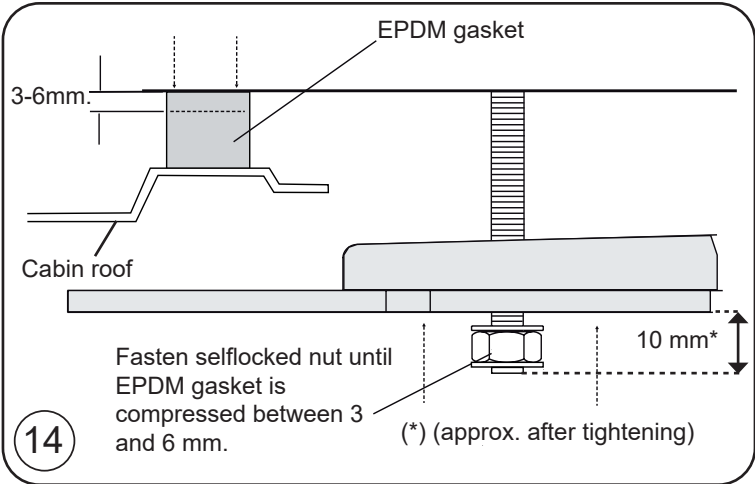

15 Tighten (4) M8 nuts to support and (4) to Unit base.

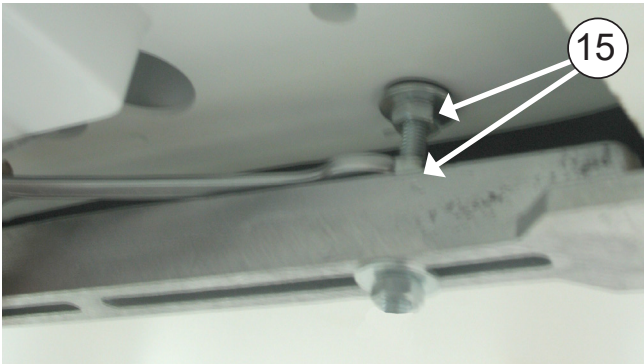

16 Position nut M6 (A) after the fastening nut of the interior air distribution panel on each stud. Position M6 hexagons, screwing up to 1 mm above the upholstery in vehicles with Space Cab and 10 mm below the upholstery in other vehicles. Unscrew M6 nuts (A) of this point until they come into contact with the hexagons, and tighten against them.

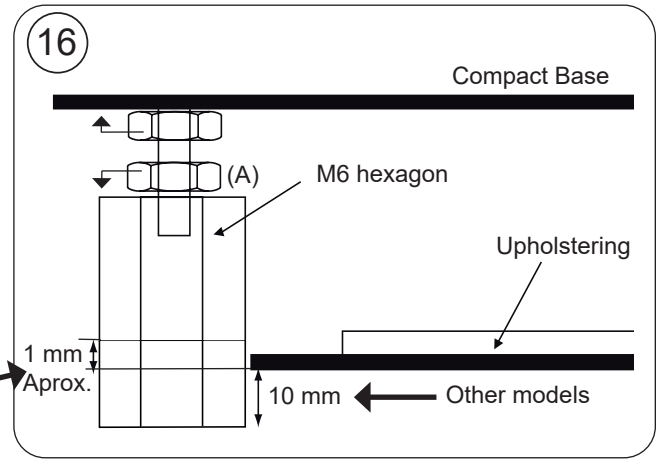

Other cabins



Cabine Super Space Cab

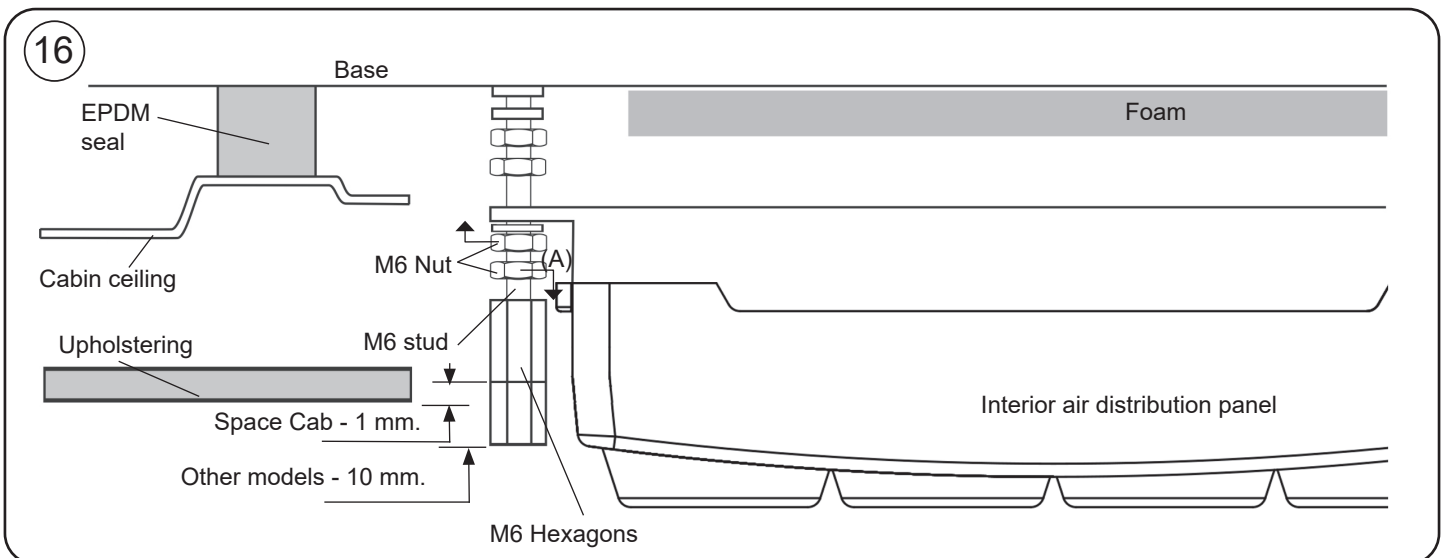

17 Place console using (4) M6/100x15 allen head screws bolts.



18 Cover the (4) nuts M6/100 x 15 allen with the round protection caps of M6 plastic.



Exploded side view to supports fastening

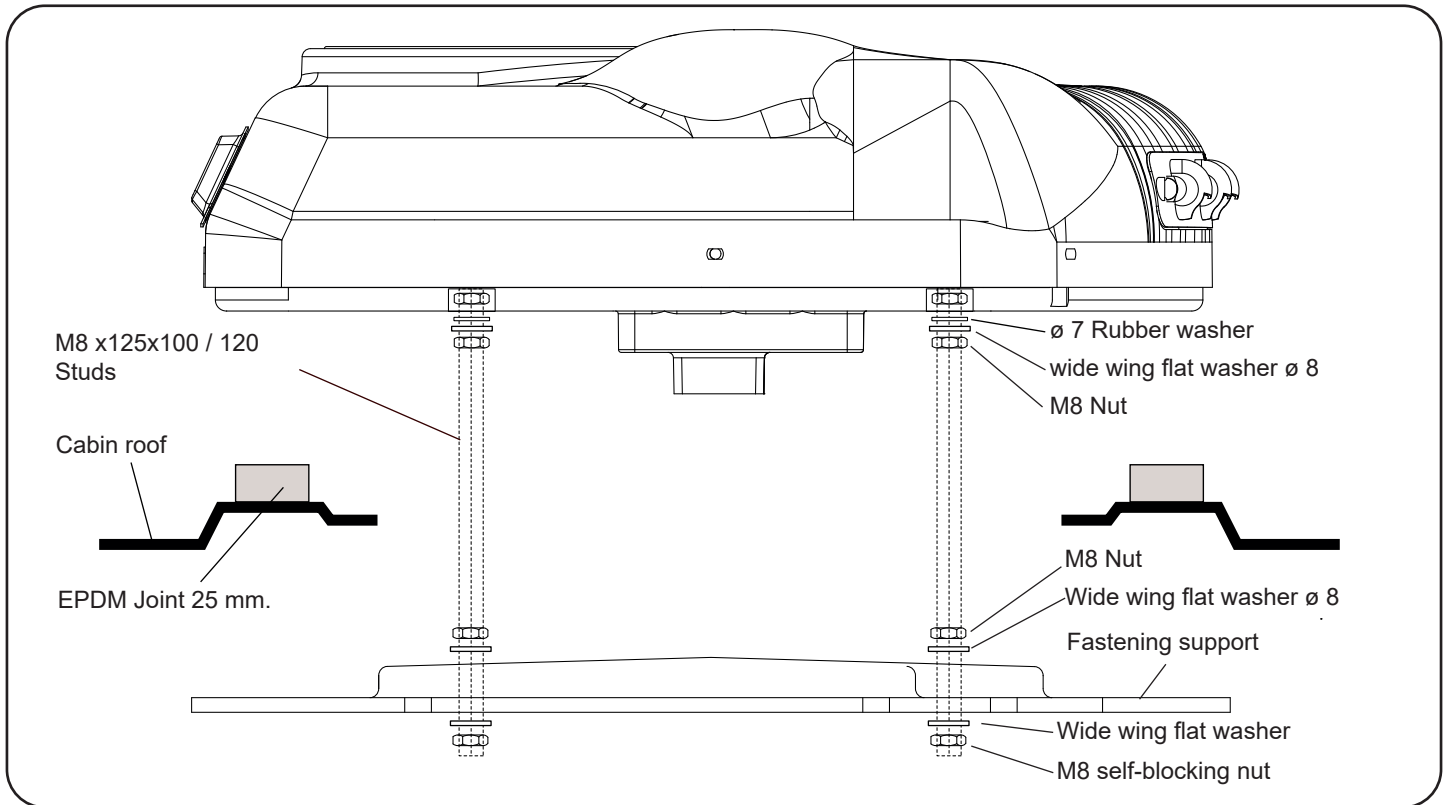

Exploded rear view to consoles fastening

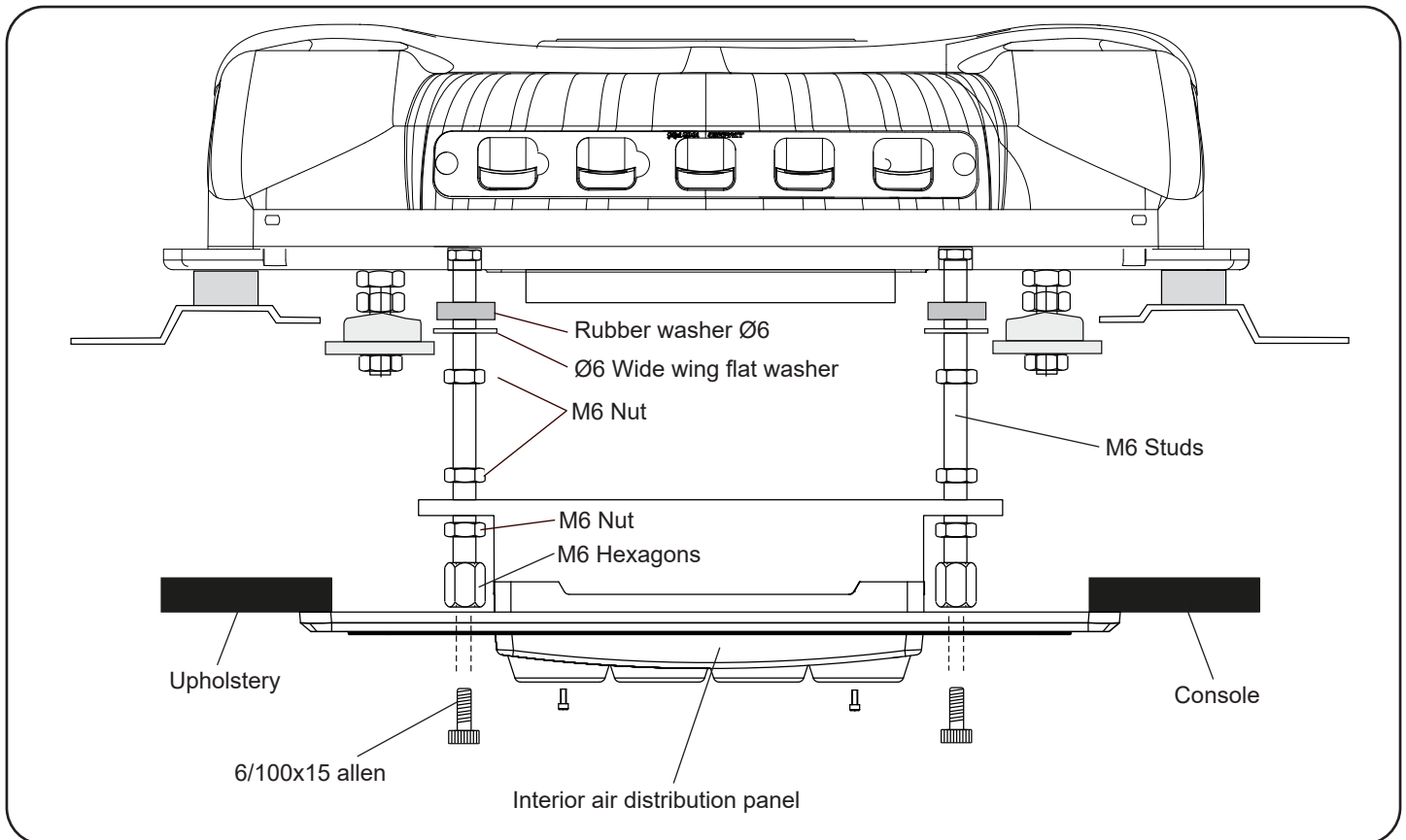

Detailed instructions on power wiring assembly

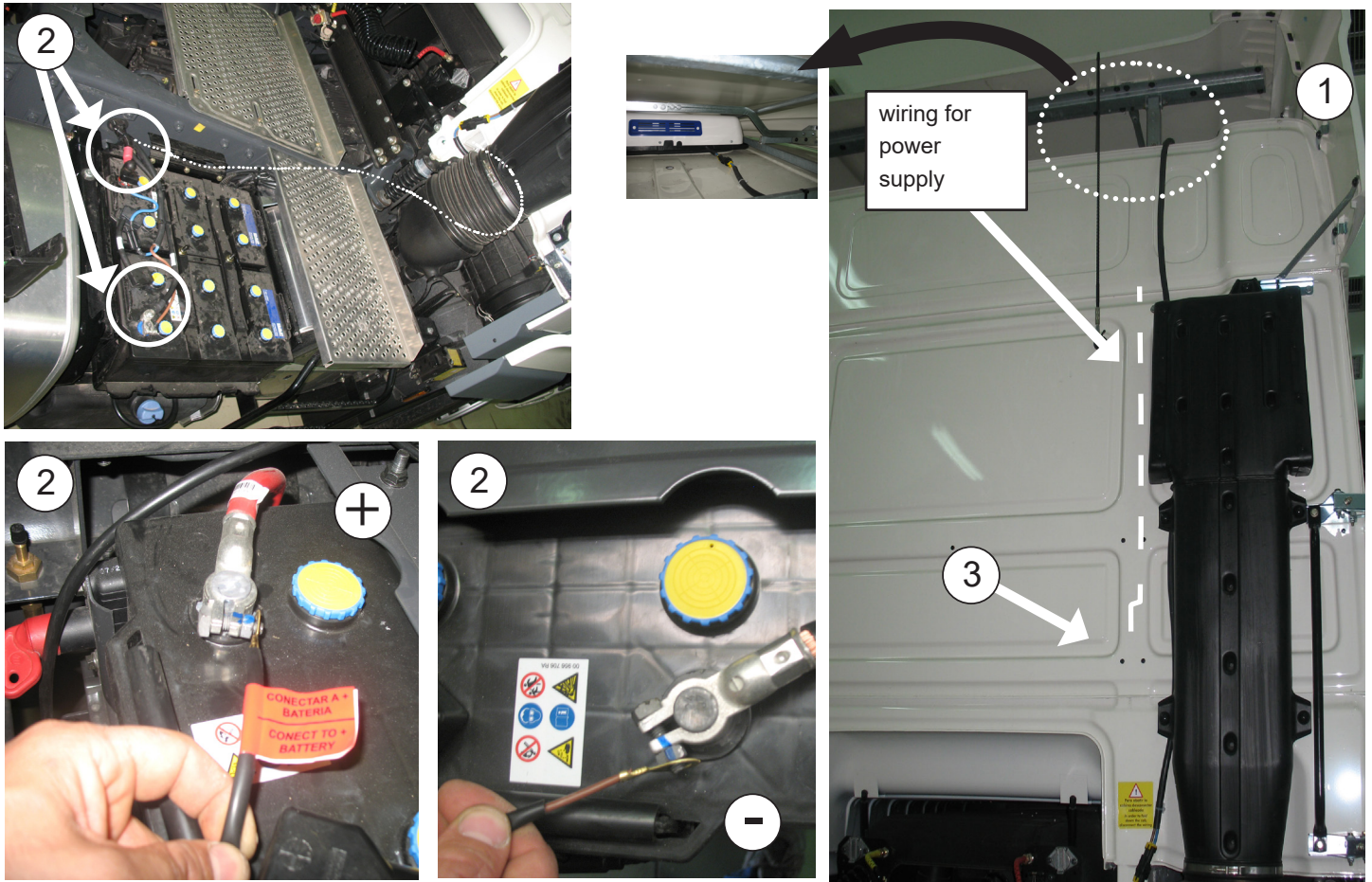

- 1- Connect the upper power supply cable to the back of equipment and lead it through the back of the cab whilst sticking down the plastic clips and securing it with flanges.
- 2- Connect the lower power supply cable to the battery by leading it through the original cable route, secured with flanges, to the back of the cab, to connect it with the upper power supply cable. **WHEN CONNECTING THE CABLES LEAVE A SUFFICIENT DISTANCE TO PREVENT THEM BREAKING DUE TO MOVEMENTS OF THE CAB!!**

IMPORTANT: Due to the equipment's complex electronic regulation system, the socket must be made directly on the vehicle's battery.

IMPORTANT: For start up please see the User's Manual.



- 3- Place danger stickers on the cable join and on the cab elevation device.



Electric wiring

IMPORTANT WARNING!

Take care not to invert polarities when connecting the unit to the power supply. If this were to happen, the unit will not work and irreparable damage will be caused to the compressor modules.

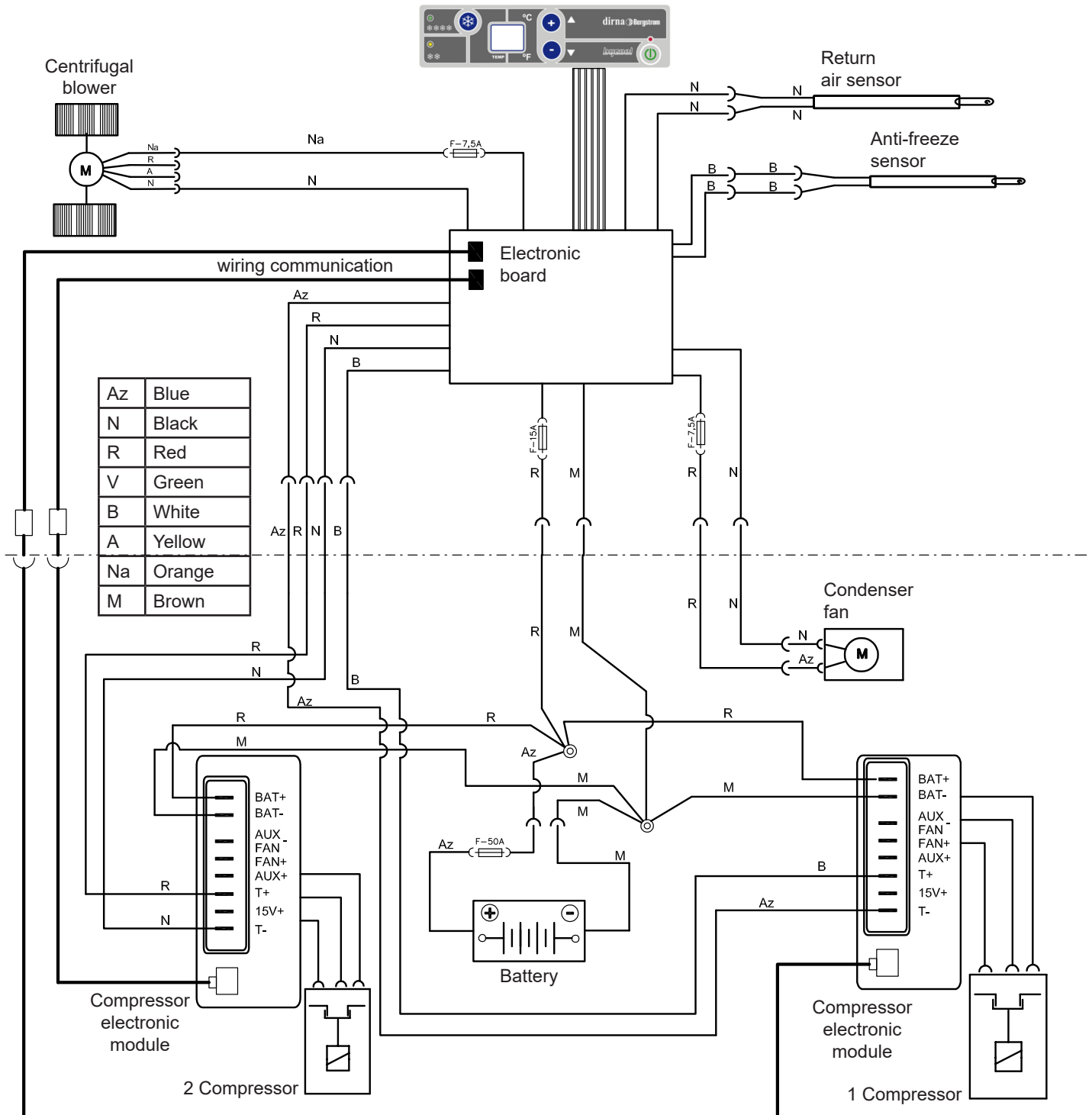

Recommandations Pour Le Montage

- Avant de commencer le montage de l'appareil, prière de lire les instructions et de les suivre attentivement.
- Utiliser les outils convenant à chaque opération.

Electricity

- Déconnecter la clé de contact.
- Déconnecter la batterie avant de commencer le montage.
- Vérifier le câblage des composants électriques et leur correcte installation.

Attention

Si pendant le montage l'équipement est incliné, il faudra attendre au moins 60 minutes avant de le mettre en marche une fois qu'il aura été remis sur sa position horizontale.

Attention

Lors de l'installation de l'appareil d'air conditionné sur le toit, il faudra protéger la partie supérieure de la cabine avec un linge ou une couverture de protection afin d'éviter les éventuelles égratignures.

Durant l'installation du **Compact**, tenir compte du fait que normalement les cabines pourvues d'écoutille possède une structure suffisamment solide pour supporter le poids de l'appareil. Cependant, si ce n'est pas le cas et qu'il est nécessaire de découper le toit ou même si disposant d'écoutille, la structure n'est pas suffisamment rigide (si elle était en fibre, plastique, etc.) il appartiendra à l'installateur de décider s'il faut renforcer le toit pour éviter toute déformation, rupture ou voie d'eau, etc., et prendre les mesures nécessaires à cet effet.



Outils

Jeu de clés Torx
 Jeu de clés Allen
 Clé fixe 10, 13, 14
 Ciseaux
 Mètre







Documentation included

Instructions de montage	1001217173
Guide de l'utilisateur	1001218019
Solution des problèmes	1001218025
Garantie	220AA10017

Symbologie

-  Fragile
-  Attention aux coupures !
-  Risque électrique

Garantie

-  L'installateur devra posséder la formation pertinente en air conditionné sur véhicules.
-  **dirna Bergstrom, s.l.**, ne sera pas responsable des dommages ou des bris dérivés d'une installation ou d'une manipulation incorrecte ni des modifications réalisées sans autorisation expresse par écrit.
-  **Appareil pré-chargé de gaz réfrigérant, R-134. (Ne pas manipuler le circuit de gaz réfrigérant).**
-  Voir la **procédure de garantie** du produit au **Diagnostic de problèmes**.
-  Voir le **Guide de l'Usager** de l'appareil pour le fonctionnement correcte de la télécommande et du tableau de commande.
-  Après l'installation, vous devez fournir à l'utilisateur: Manuel d'utilisation, garantie et diagnostic de pannes.

 Avant de commencer le montage, monter la grille d'entrée d'air frontale.



1 Si le véhicule dispose de spoiler, demande le kit 0911020014.

2 Démontez le couvercle de l'écouille, les éléments de fixations et les remettre au client (*).

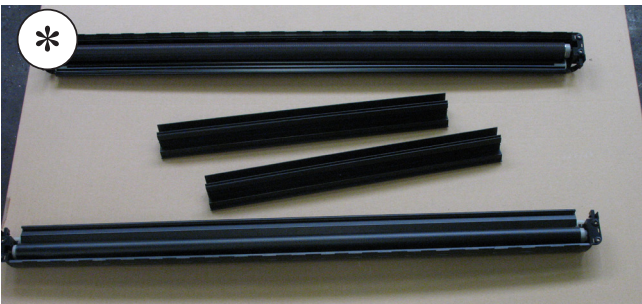

3 Éliminer les restes d'adhésif de la surface supérieure de la cabine avant de coller le joint EPDM.

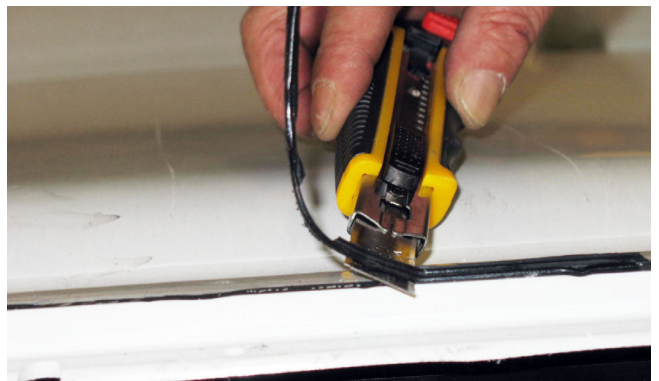
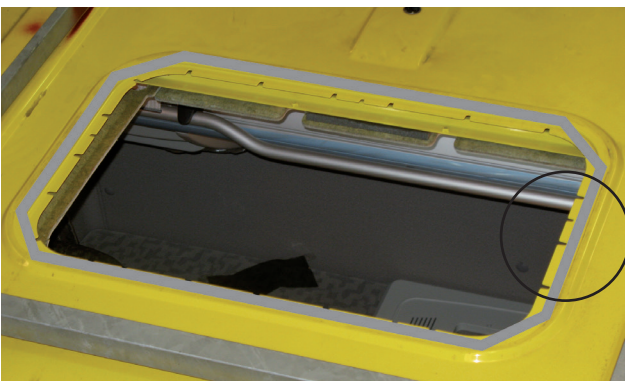

4 Si le spoiler a une barre centrale, couper la barre dans la zone à points afin de pouvoir installer l'appareil.



4a Coller le joint EPDM autour de l'orifice de l'écoutille (voir détail pour découper les bords).

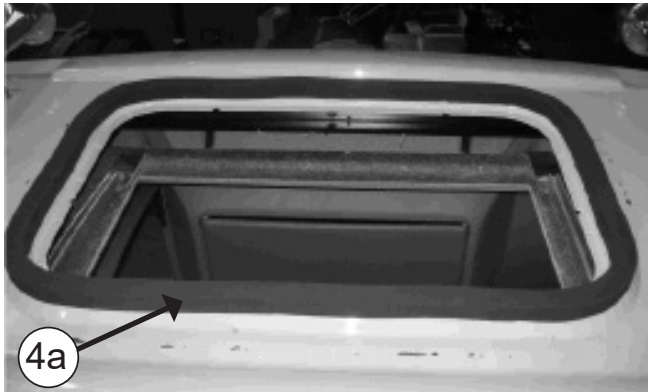

 **COMMENT COUPER LE JOINT EPDM POUR EVITER LES FILTRATIONS DANS LA CABINE**

A- Coller le joint en maintenant une protection en papier de 100 mm de chaque côté.

B- Retirer les deux morceaux de papier.

C- Coller en faisant pression sur les deux extrémités.

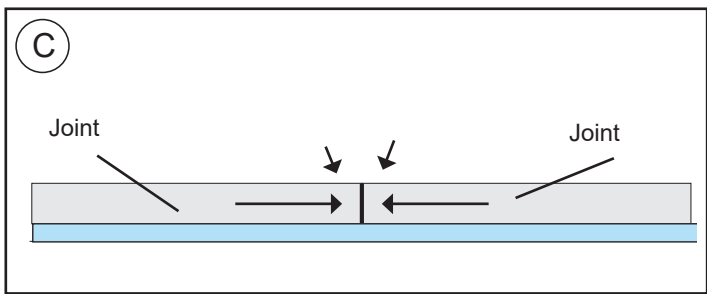
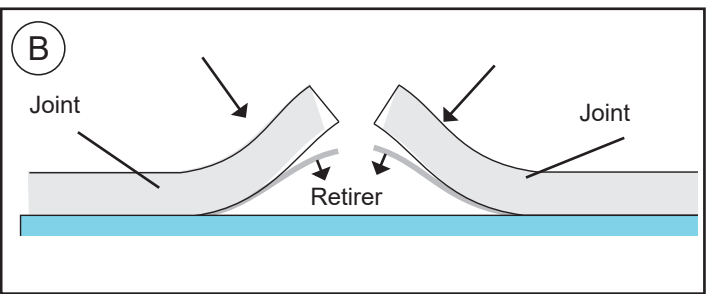
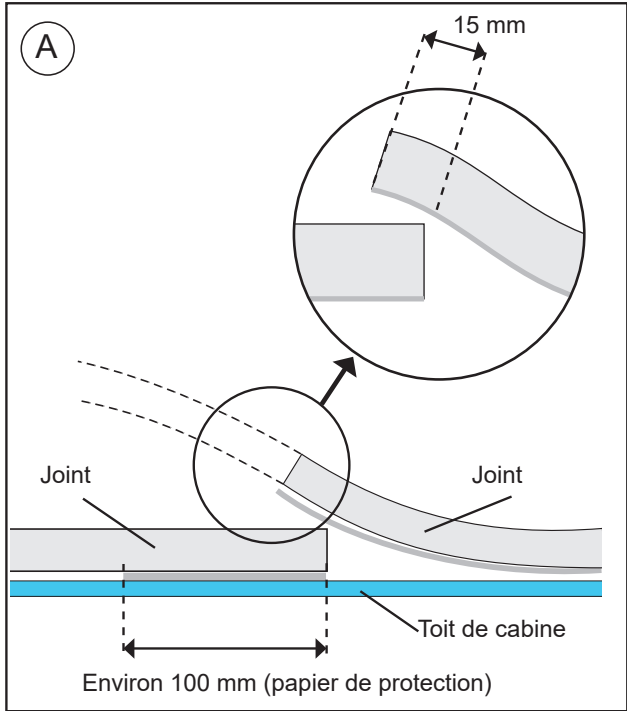

5

EXTERIEUR CABINE:

Positionner le Compact dans l'espace prévu.

Attention ! Avant de placer l'équipement sur le creux de l'écouille, vérifier que les sorties d'écoulement ne soient pas bouchées par le joint EPDM.

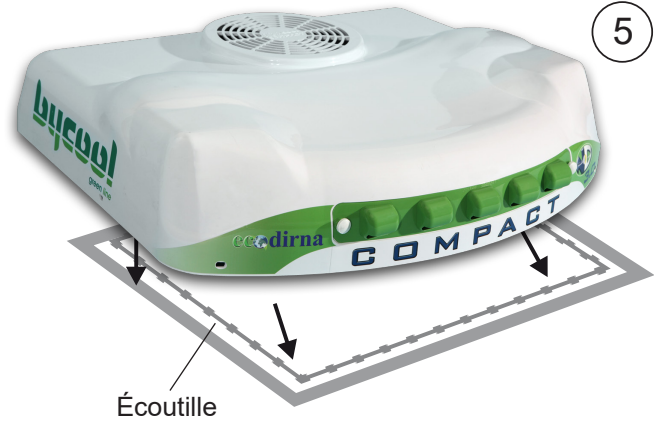

6

Placer le canalisateur en caoutchouc mousse en laissant la partie la plus molle sur la base de l'équipement.

Attention: en fonction de la cabine, il est possible de devoir utiliser les (2) canalisateurs fournis pour que le panneau de distribution d'air reste totalement ajusté avec ces derniers.



7

INTERIEUR CABINE:

Visser 5 mm environ (4) goujons de 8/125x70, 100 ou 120 mm, en fonction de la distance plus ou moins grande de l'appareil jusqu'à ce qu'en positionnant les supports de fixation, il ne reste que 20 mm au-dessous de ces supports.

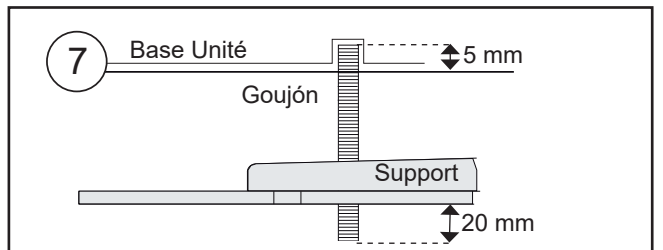

8

en suivant cet ordre :

- rondelle a mousse
- rondelle plain diamètre 8 aile large
- écrou M8
- plain rondelle diamètre 8 aile large

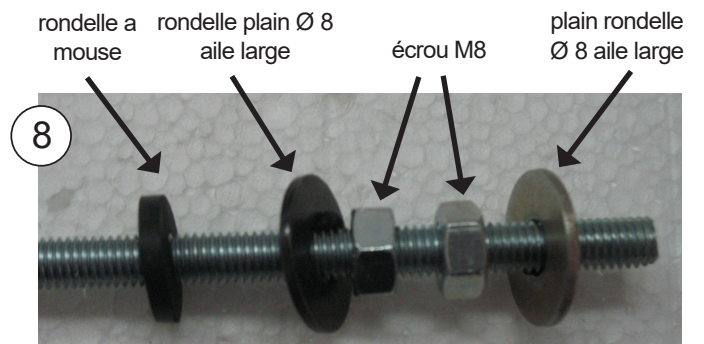

8a

Placer les supports de fixation (2), avec une rondelle (1) et un écrou autobloquant (1) M8, sans serrer.

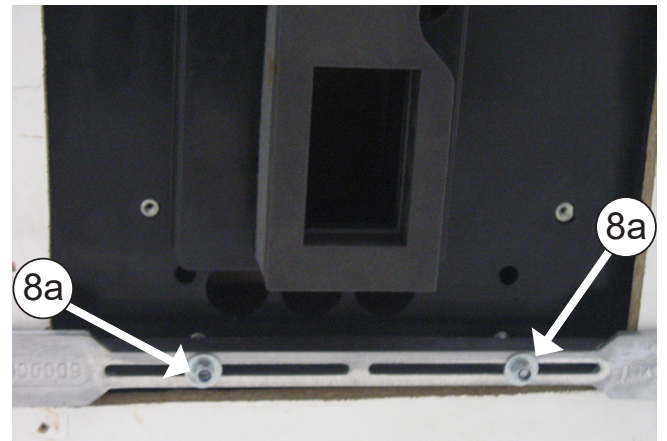
**9**

Visser 10 mm les goujons (4) M6 x 80, comme indiqué au (D) du schéma point 16.

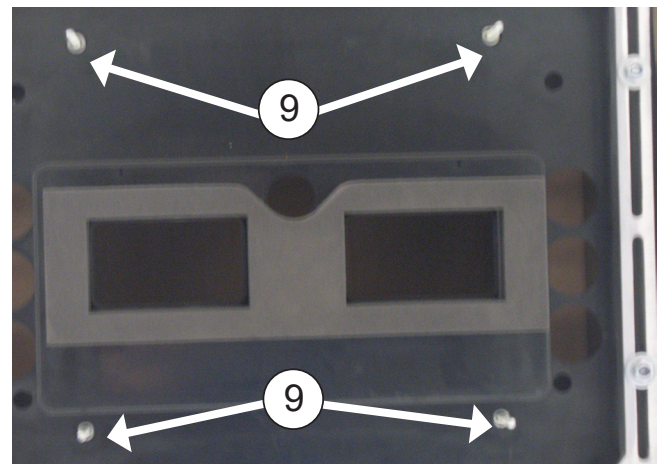
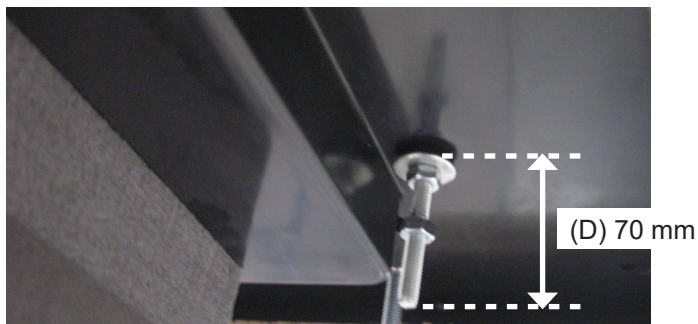
**10**

Placer (1) rondelle mouse diamètre 6 (1) plain rondelle diamètre 6 aile large et (1) écrou M6 sur chacun des asperges M6. En suivant serrer l'écrou jusqu'à la rondelle à mouse reste un peu pressée.

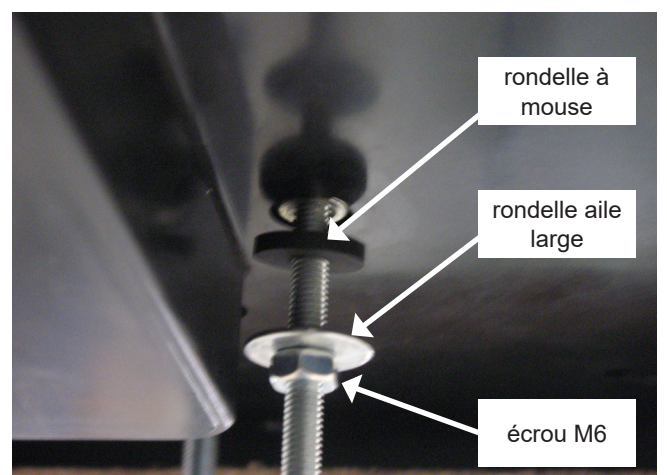

10a Placer l'écrou (1) M6 sans le serrer sur chaque goujon.

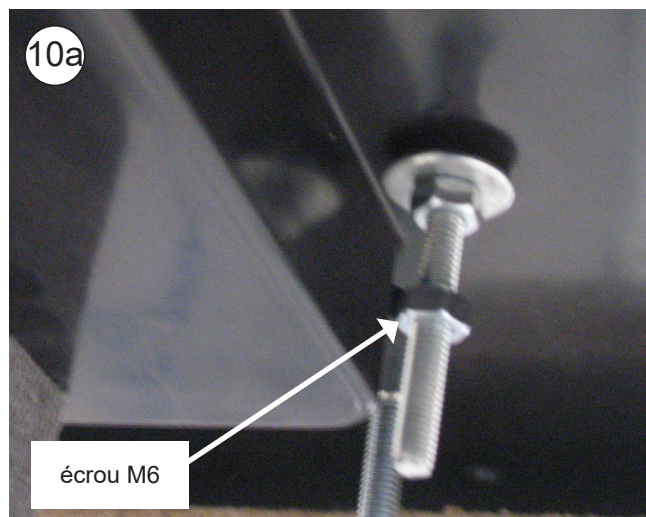

10b Entre la base et le panneau inférieur de distribution d'air, connecter (2) boîtes à deux voies de capteur antigel (câbles blancs) et capteur d'air de retour (câbles noirs), la boîte à 4 voies du souffleur, (2) câbles de communication et la boîte à 8 voies de câblage à la connexion avec contrôle électronique.

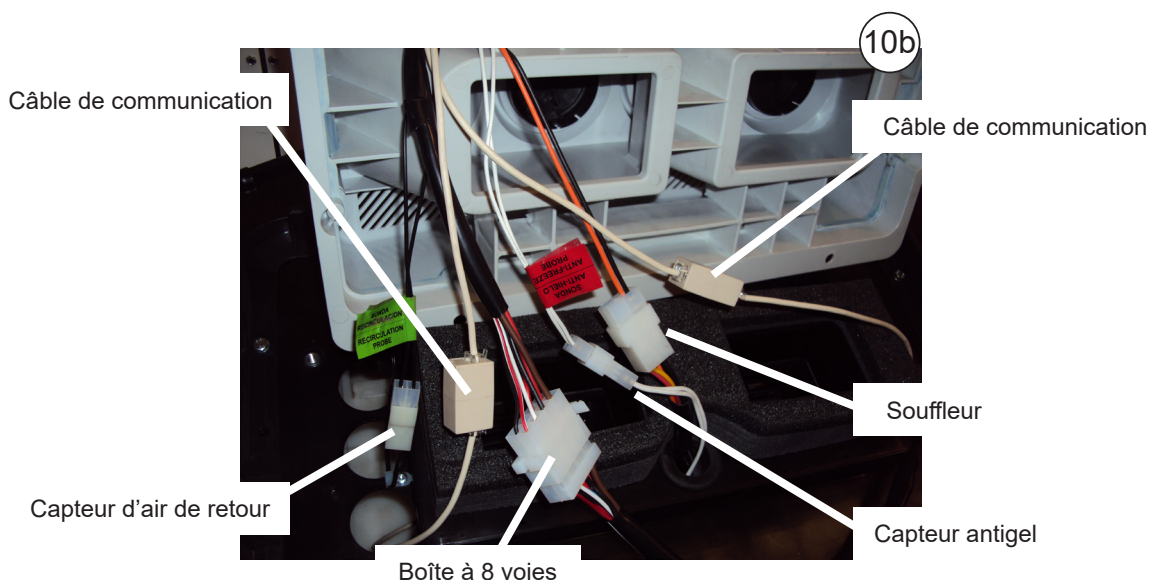

11

Placer le panneau intérieur de distribution d'air dans les goujons précédents avec (1) rondelle M6 surface large et (1) écrou M6 sur chaque goujon. Serrer les écrous jusqu'à ce que le canalisateur du panneau intérieur de distribution d'air heurte le caoutchouc mousse supérieur de l'équipement.

Important : les canaliseurs du panneau intérieur de distribution d'air doivent heurter le caoutchouc mousse supérieur de l'équipement pour éviter des fuites d'air.

Attention de ne pas coincer les câblages entre le canalisateur et le caoutchouc mousse placé dans la base de l'équipement.

11

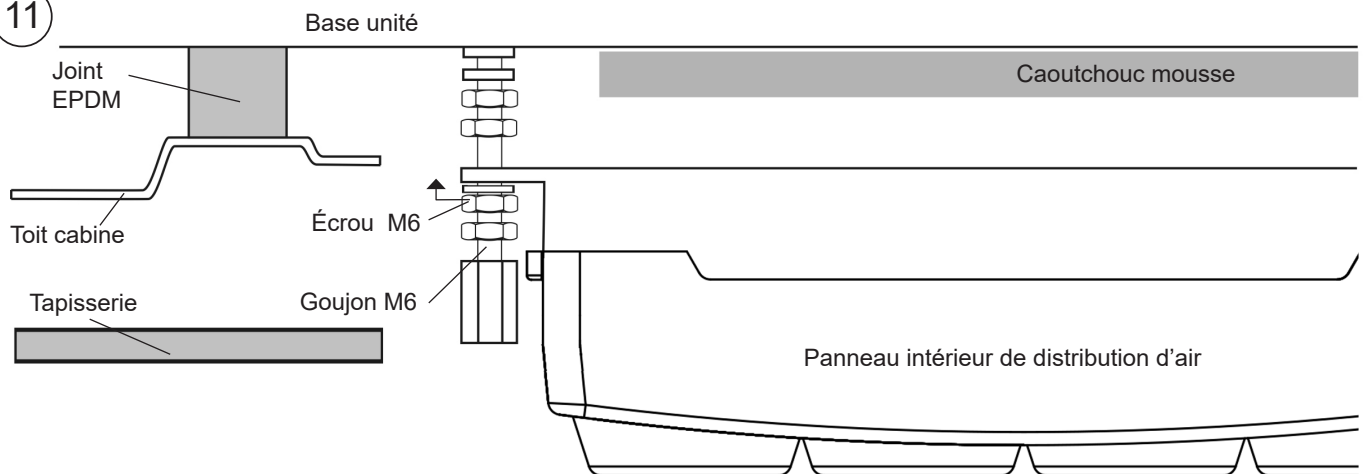

12

Apretar tuerca del punto 10a hasta hacer tope con la parte superior del panel interior de distribución de aire.

12

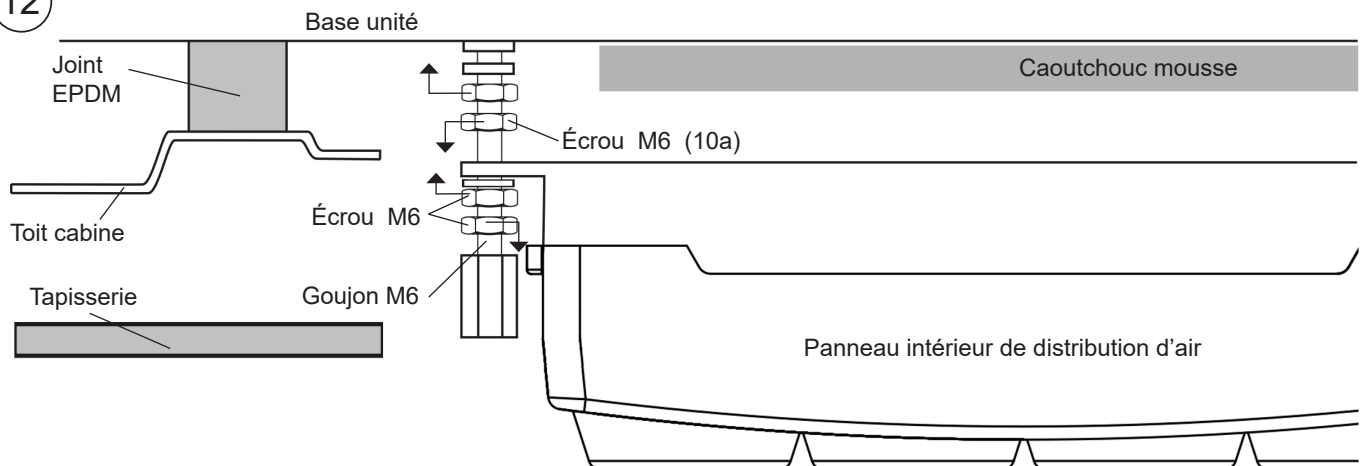

13

Placer la console et centrer l'appareil sur la partie convenant le mieux du toit de la cabine. Une fois centrée, retirer la console pour l'installer plus tard.

14

Fixer les supports en serrant les écrous jusqu'à serrer le joint EPDM (**Point 4a**) de l'appareil entre 3 et 6 mm; le joint EPDM doit rester avec une épaisseur entre 19 et 22 mms.

Important: Pour éviter la filtration d'eau dans la cabine, vérifier le serrage du serrage du joint EPDM à la base du Compact, comme indiqué sur le **diagramme**.



Vérifier la compression du joint EPDM en utilisant un flexomètre dans les quatre cous.

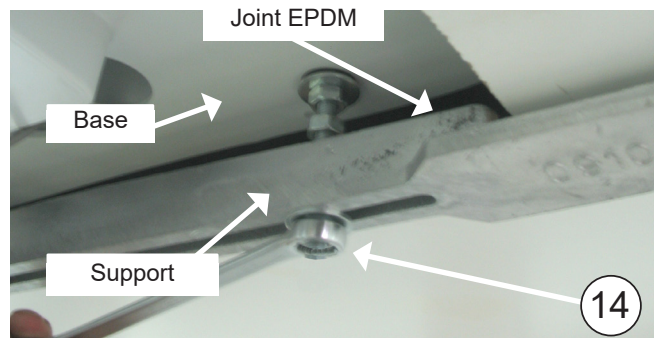
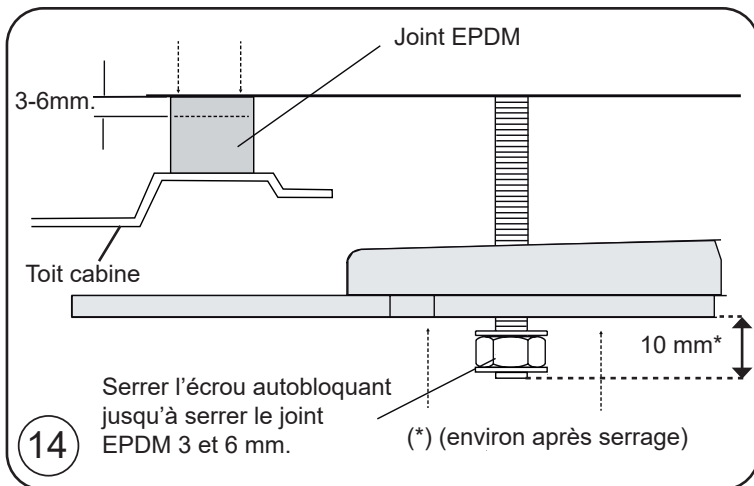

15

Serrer les écrous (4) M8 afin de fixer à (4) l'unité base.

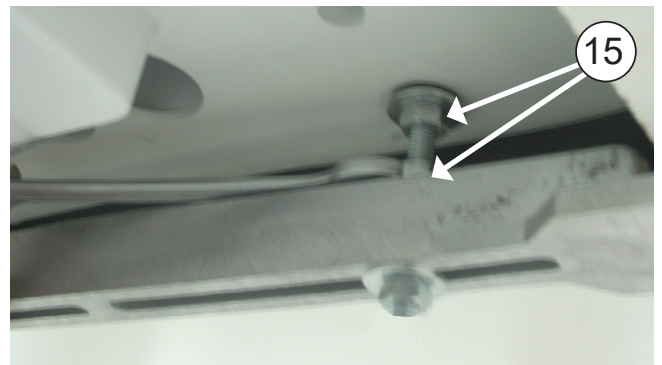

16

Placer l'écrou M6 (A) après l'écrou de fixation du panneau intérieur de distribution d'air sur chaque goujon. Placer des hexagones M6 et les visser jusqu'à ce qu'ils dépassent de 1 mm au-dessus de la tapisserie dans les véhicules à cabine Super Space Cab et restent 10 mm au-dessous de la tapisserie pour le reste des véhicules. Dévisser les écrous M6 (A) de ce point jusqu'à ce qu'ils butent contre les hexagones puis les serrer contre ces derniers.

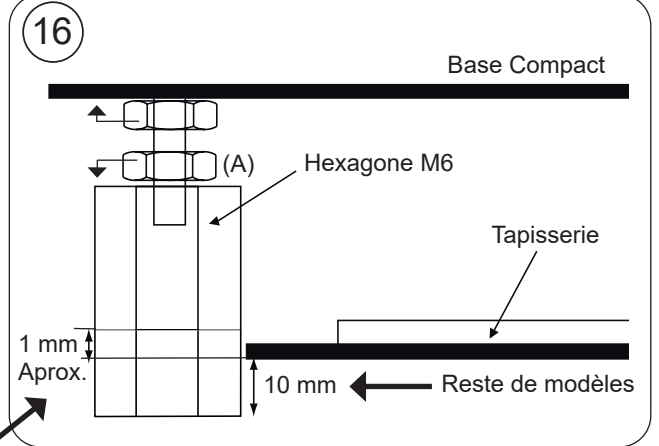

Super Space Cab



Reste de cabines



Cabine Super Space Cab

16

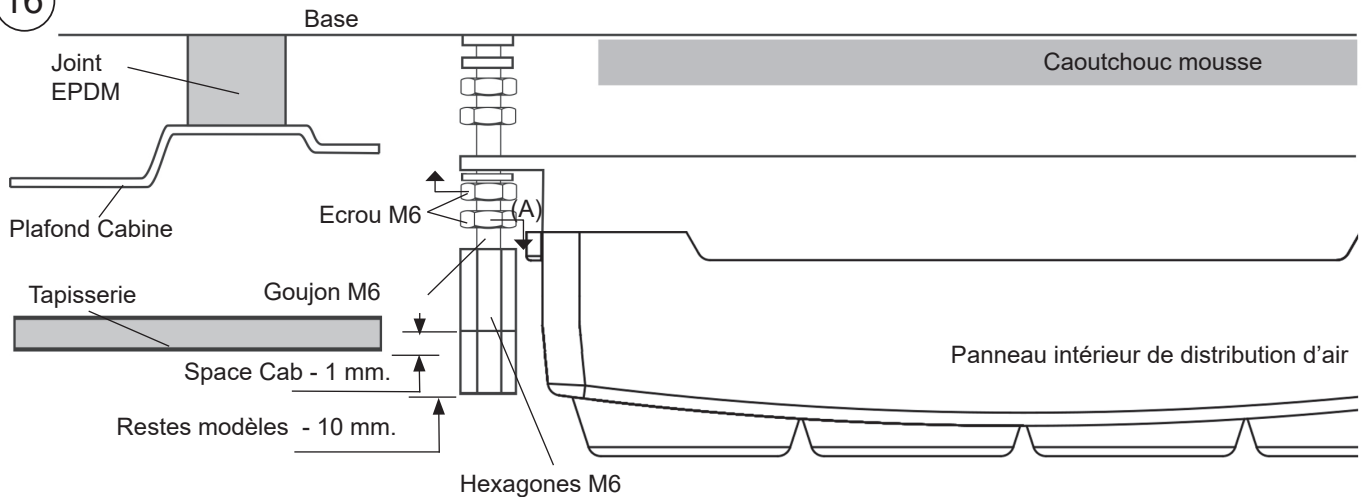

17 Placer la console à l'aide des (4) vis Allen M6/100x15.



18 Couvrir les têtes des vis Allen (4) M6/100x15 avec les capuchons en plastique M6.



Vue explosée jusqu'à la fixation des supports de fixation

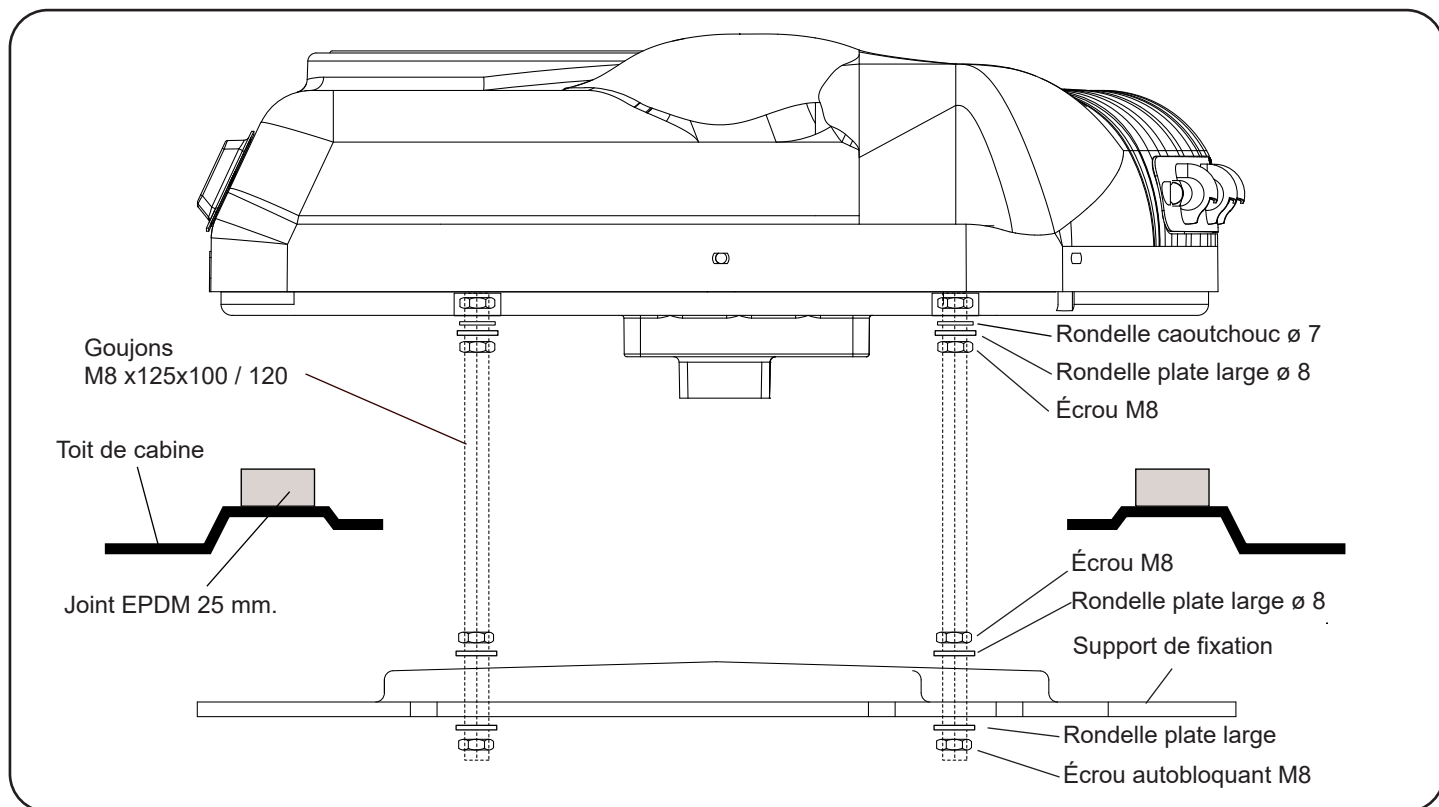

Vue explosée jusqu'à fixation des consoles

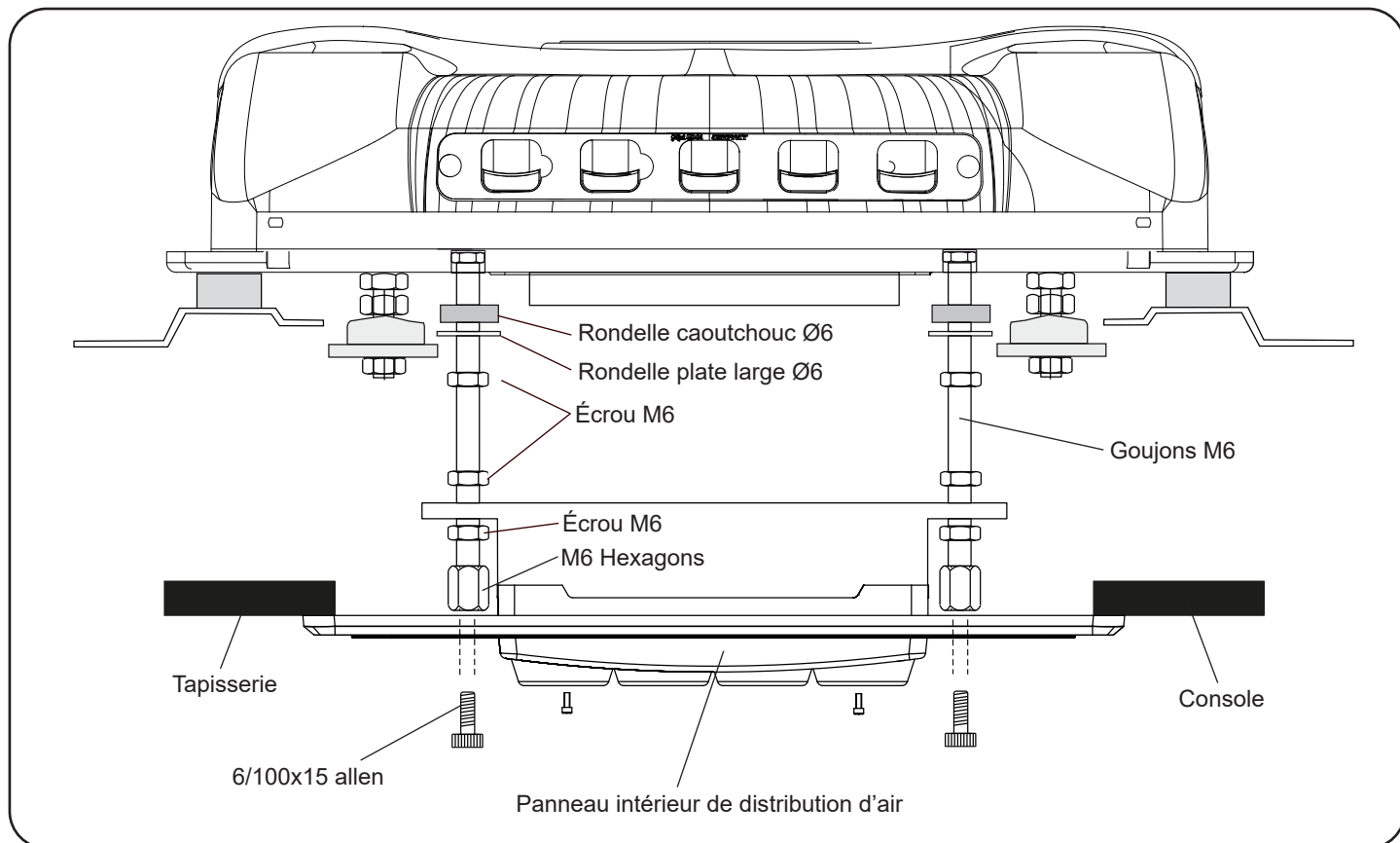

Instructions détaillées sur l'installation du câblage d'alimentation

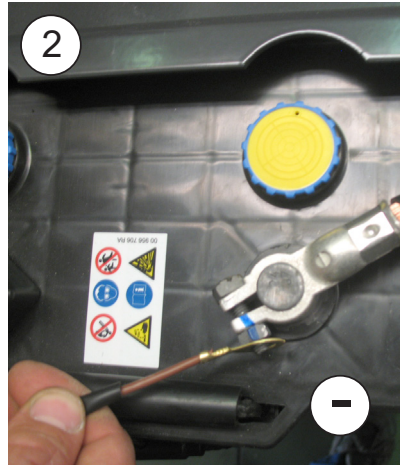
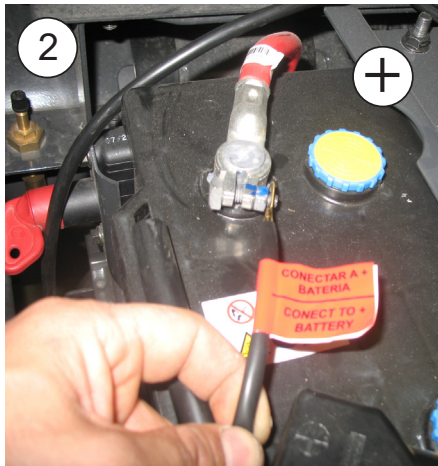
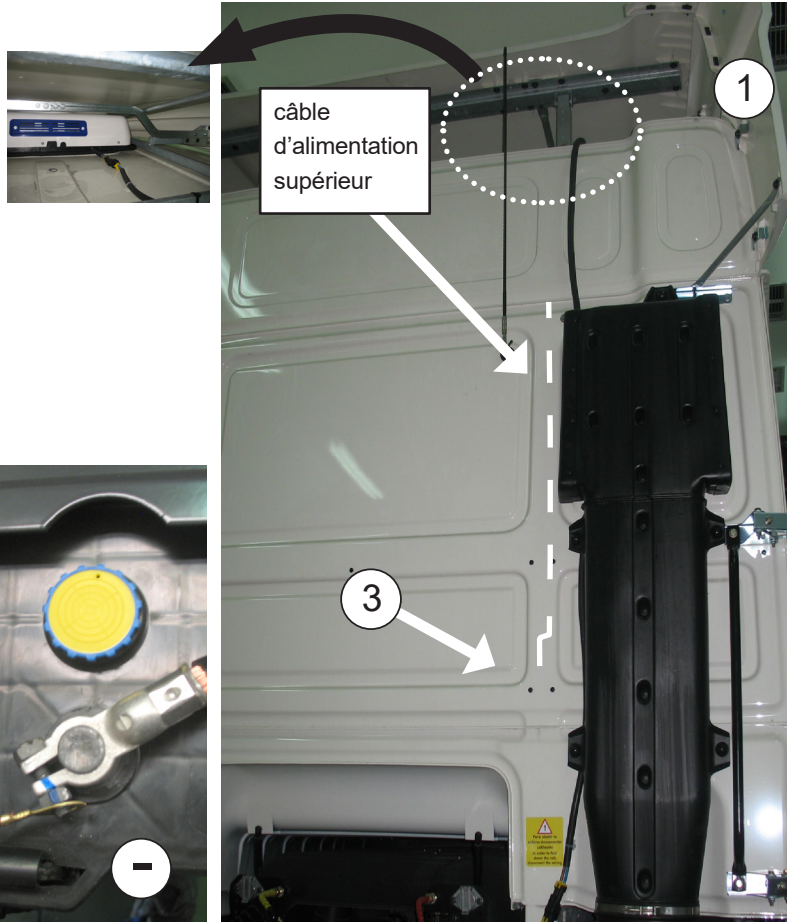
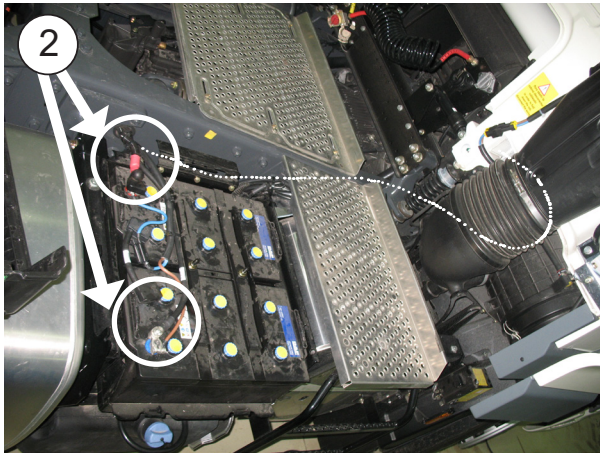

- 1- Connecter le câble d'alimentation supérieur à la partie arrière de l'appareil et le conduire par la partie postérieure de la cabine en collant les supports en plastique et en le fixant avec des brides.
- 2- Connecter le câble d'alimentation inférieur à la batterie, en le conduisant par le passage de câblage original, fixé avec des brides, vers la partie postérieure de la cabine, afin de connecter au câble d'alimentation supérieur. **LORS DU BRANCHEMENT DES CÂBLAGES, LAISSER LA DISTANCE PERTINENTE AFIN D'ÉVITER LEUR RUPTURE DUE AUX MOUVEMENTS DE LA CABINE!**

IMPORTANT: En raison du système complexe de réglage électronique de l'appareil, la prise de courant sera directement effectuée sur la batterie du véhicule.

IMPORTANT: Pour la mise en marche, consulter le Manuel de l'Usager.



- 3- Placer des adhésifs de danger à l'union de câblage et sur le dispositif d'élévation de la cabine.



Câblage électrique

AVERTISSEMENT IMPORTANT!

Attention ! Ne pas inverser les polarités dans la connexion de l'alimentation à l'équipement. Si cela se produisait, la plaque ne s'allumerait pas, l'équipement ne fonctionnerait pas et des dommages irréparables se produiraient sur les modules des compresseurs.

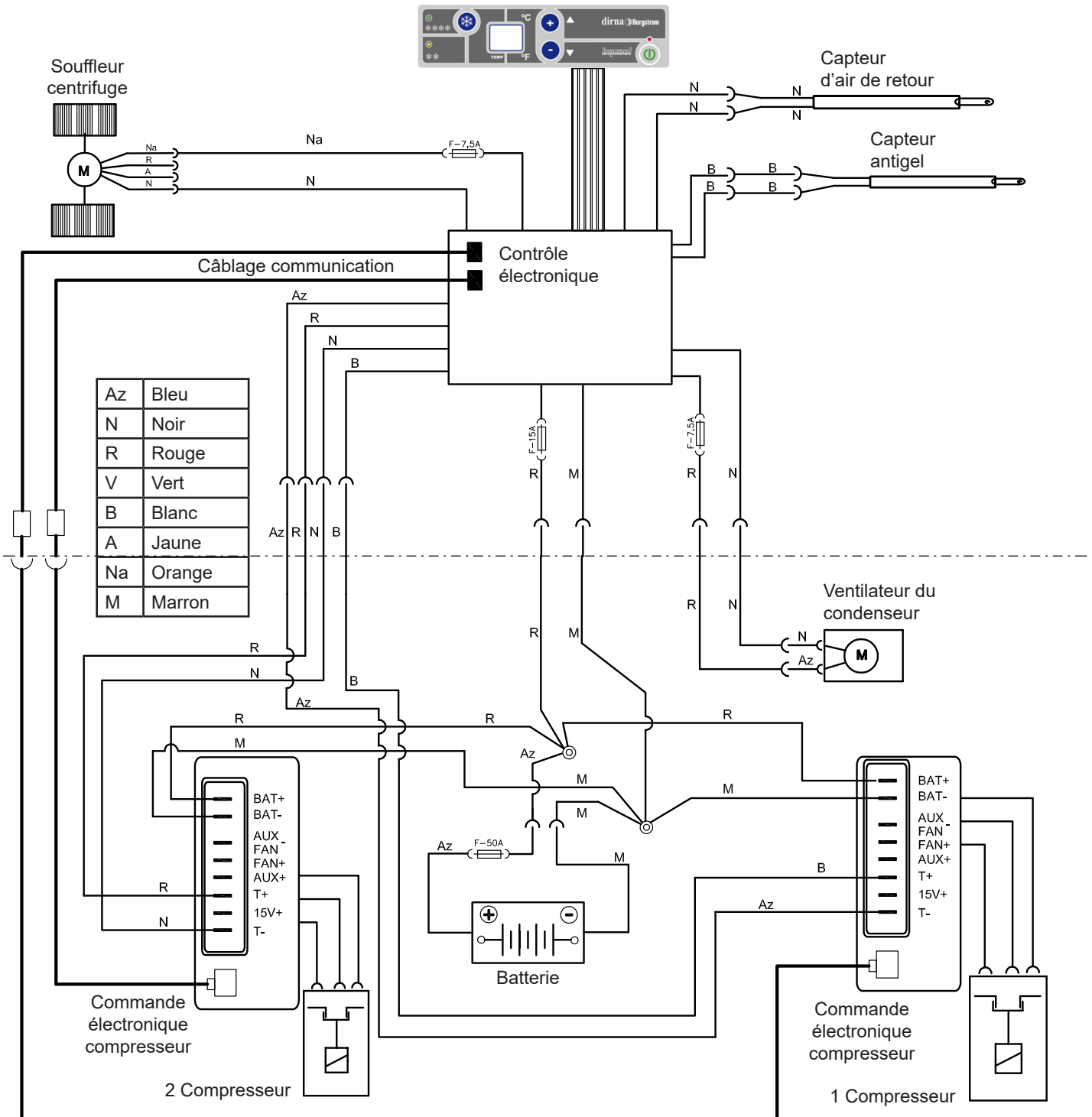

Empfehlungen Zur montage

- Vor und während der Montage bitte diese Anweisungen lesen und beachten.
- Benutzen Sie für jeden Arbeitsschritt die geeigneten Werkzeuge.

Elektrizität

- Zündschlüssel abziehen.
- Vor Montagebeginn die Batterie abklemmen.
- Den ordnungsgemäßen Anschluss und die korrekte Installation der Elektrokomponenten überprüfen.

Achtung

Sollte sich das Gerät während der Montage neigen, muss man mindestens 60 Minuten warten, nachdem es wieder in die horizontale Lage gebracht wurde, um es wieder einzuschalten.

Achtung

Wird die Klimaanlage im Kabinendach installiert, muss der obere Teil der Kabine mit einem Tuch oder einer Decke gegen eventuelle Kratzer geschützt werden. Bei der Installation der **Compact** auf dem Kabinendach muss darauf geachtet werden, dass mit Luken ausgestattete Kabinen über eine ausreichend stabile Struktur verfügen, um das Gewicht des Geräts stand zu halten. Sollte das Fahrzeug über keine Luke verfügen und sollte es notwendig sein, das Kabinendach aufzuschneiden, bzw. sollte die vorhandene Struktur nicht ausreichend stabil sein (z.B. wenn sie aus Faser, Kunststoff usw. hergestellt ist), obliegt es dem Installateur zu entscheiden, ob das Kabinendach zur Vermeidung von Verformungen, Brüchen, undichten Stellen usw. verstärkt werden muss, und die hierfür notwendigen Mittel bereit zu stellen.

Werkzeuge

- Torx-Schraubenschlüssel
- Inbusschraubenschlüssel
- 10er, 13er, 14er Schraubenschlüssel
- Schere
- Metermaß

Mitgelieferte unterlagen

Montageanweisungen	1001217173
Benutzerleitfaden	1001218019
Fehlerdiagnose	1001218025
Garantie	220AA10017

Symbologie



Fragile





Attention aux coupures !



Risque électrique

Warnhinweise

 Der Installateur muss im Bereich Fahrzeug-Klimaanlagen ausreichend geschult sein.

 **dirna Bergstrom, s.l.** übernimmt keine Verantwortung für Schäden oder Brüche aufgrund einer nicht ordnungsgemäßen Installation oder Bedienung des Geräts oder den Austausch von Teilen bzw. Umbauten, die ohne die erforderliche schriftliche Genehmigung durchgeführt wurden.

 **Mit Kältemittel vorgefülltes Gerät R-134a. (Kältemittelkreislauf nicht manipulieren).**

 Siehe **Garantieverfahren** des Produkts in der **Fehlerdiagnose**.

 Siehe **Benutzerleitfaden** des Geräts für den ordnungsgemäßen Betrieb der Fernbedienung und des Bedienfelds.

 Die folgenden Unterlagen müssen dem Benutzer nach der Installation ausgehändigt werden: **Benutzerleitfaden, Garantie und Fehlerdiagnose.**

 Vor Montabeginn vorderes Lufteintrittsgitter montieren.



1 Sollte das Fahrzeug mit Spoiler geliefert werden, Kit 0911020014 bestellen.

2 Den Lukendeckel und die Befestigungselemente entfernen und dem Kunden aushändigen (*).

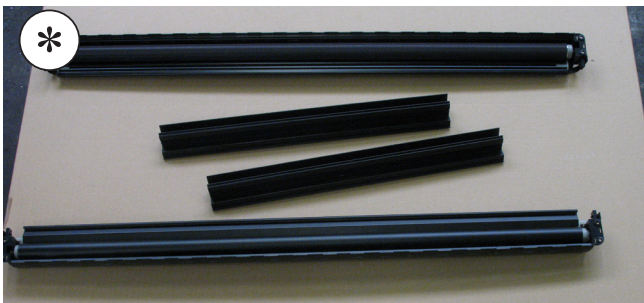

3 Vor dem Ankleben der EPDM-Dichtung die Klebstoffreste von der oberen Kabinenfläche entfernen.

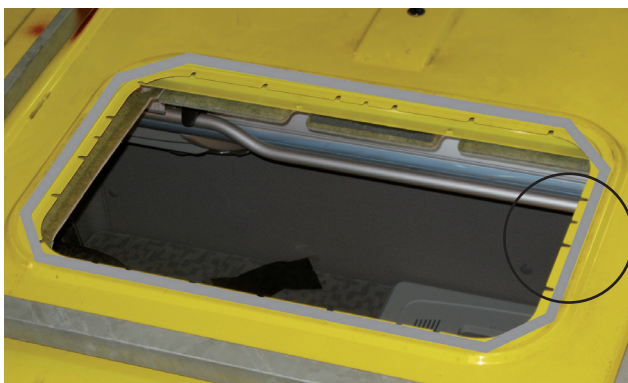

4

Falls der Spoiler eine Mittelstange hat, diese im Bereich der Punkte schneiden, um das Gerät installieren zu können.



4a

Die EPDM-Dichtung um die Lukenöffnung herum ankleben (siehe Detailansicht für das Schneiden der Ränder).

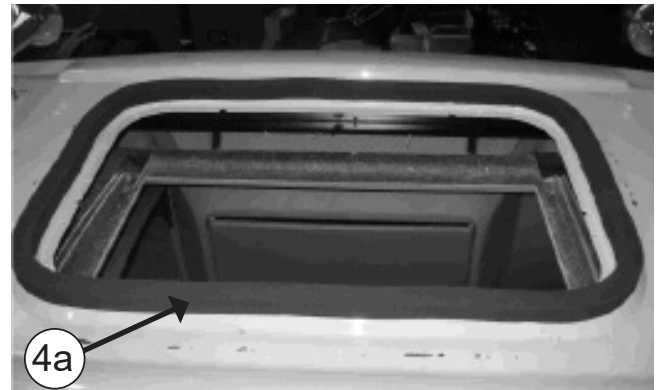

WIE DIE EPDM-DICHTUNG GESCHNITTEN WIRD, UM FILTRATIONEN IN DER KABINE ZU VERMEIDEN

- A- Dichtung aufkleben und dabei einen Papierschutz von 100 mm auf jeder Seite beibehalten.
- B- Die zwei Papierstücke entfernen.
- C- Unter Anpressen beider Enden aufkleben.

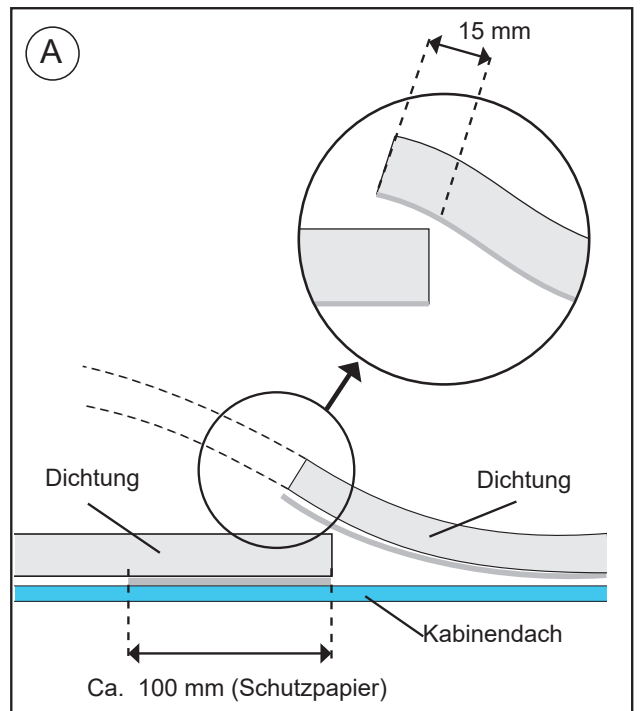

B

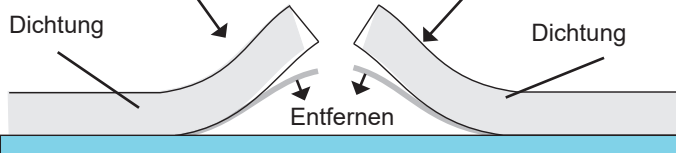

C

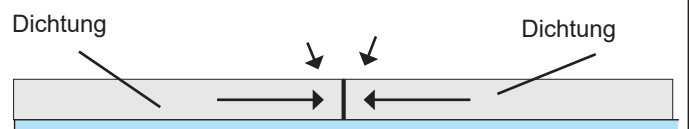

5 **KABINENAUSSENSEITE:**
Compact in der Öffnung positionieren.

Achtung! Beim Auflegen des Geräts auf die Lukenaussparung darauf achten, dass die Ablassausgänge nicht von der EPDM-Dichtung zusammengedrückt werden.

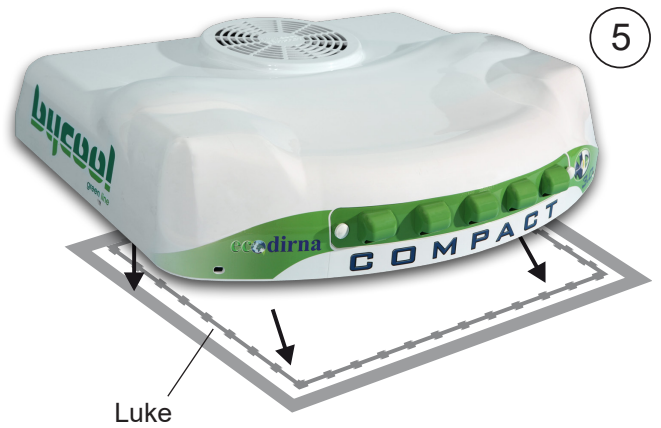
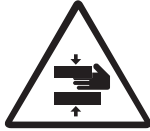

6 Schaumgummidurchführung anbringen, wobei der weichere Teil auf der Gerätegrundplatte aufliegt.

Achtung: Je nach Kabine kann es erforderlich sein, die (2) mitgelieferten Führungen zu verwenden, damit die Luftverteiltertafel ordnungsgemäß ausgerichtet ist.



7 **KABINENINNENSEITE:**
Ca. 5 mm Gewinde für (4) Stiftschrauben 8/125x70, 100 oder 120 mm schneiden (abhängig vom größeren oder kleineren Abstand vom Gerät bis sie nach Positionierung der Befestigungsauflagen 20 mm unter diesen liegen).

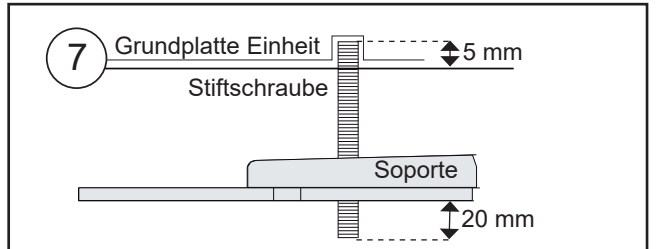

8 Montieren Sie wie folgt:
Gummischeibe / 3D Unterlegscheibe / Mutter / Gewindestange.

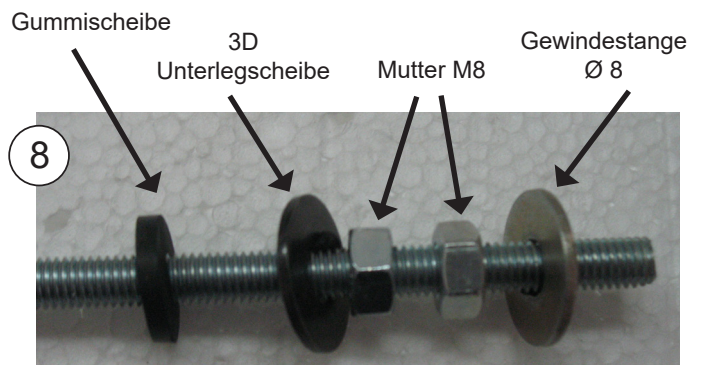

8a Befestigungsauflagen (2) mit einer Unterlegscheibe (1) und einer Autobloc-Mutter (1) M8 einlegen, **jedoch ohne anzuziehen**.

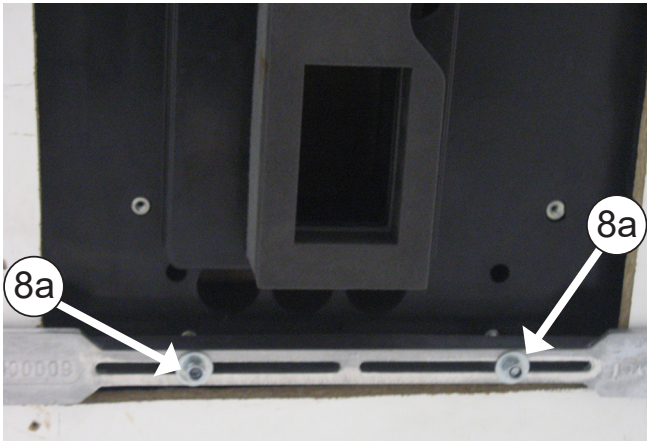

9 10 mm Gewinde für die Stiftschrauben (4) M6 x 80 am angegebenen Punkt schneiden laut Distanz (D) beschrieben in Abbildung 16.

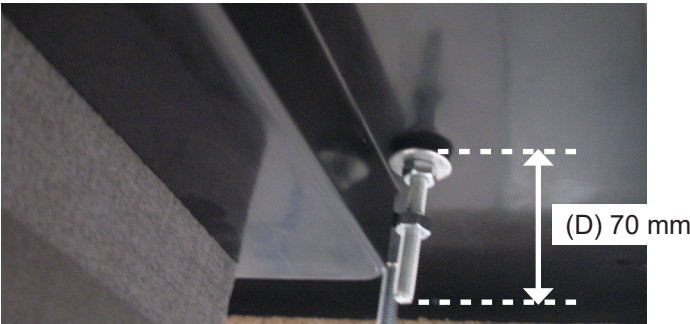
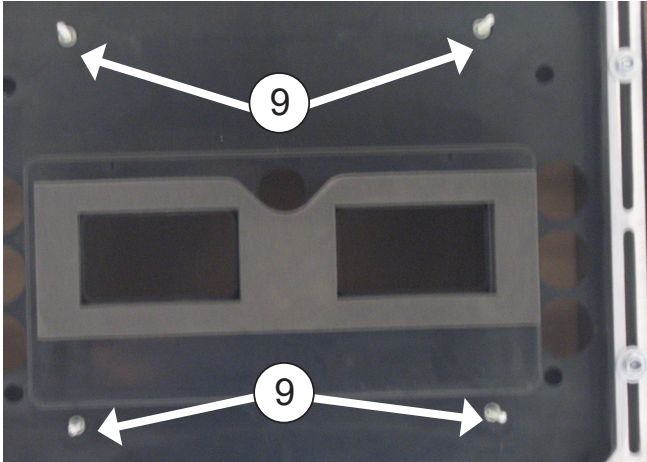

10 Montiere (1) Gummi-Unterlegscheibe, (1) 3D Unterlegscheibe (1) Mutter auf jede Gewindestange. Später ziehen Sie die Mutter an, bis die Gummischeibe ein wenig zusammengepresst ist.

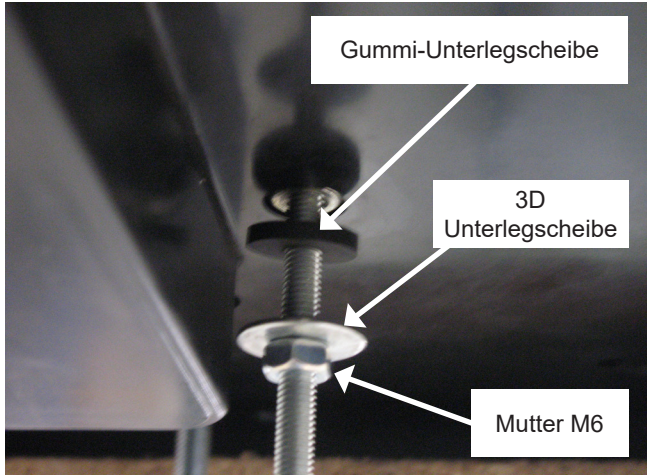

10a Jeweils die Mutter (1) M6 **ohne Anziehen** auf die Stiftschrauben legen.

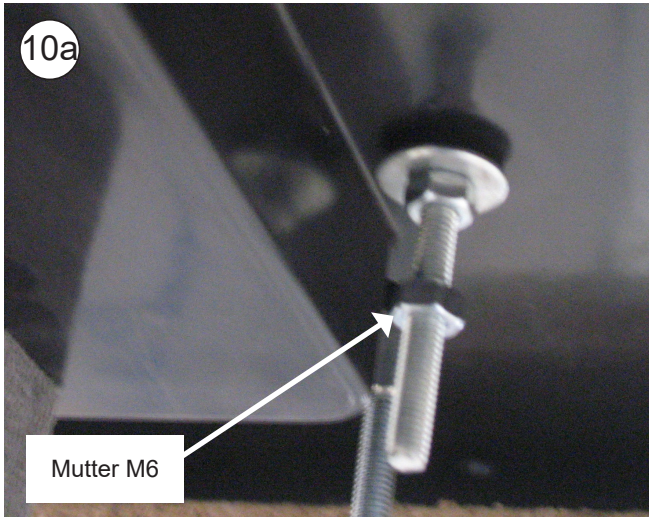

10b Zwischen der Grundplatte und der inneren Luftverteiltertafel (2) 2-Wege-Kästen von Frostschutzfühler (weiße Kabel) und Rückführsonde (schwarze Kabel), 4-Wege-Kasten des Gebläses, (2) Kommunikationskabel und 8-Wege-Kasten der Anschlussverkabelung zur Elektroniksteuerung anschließen.

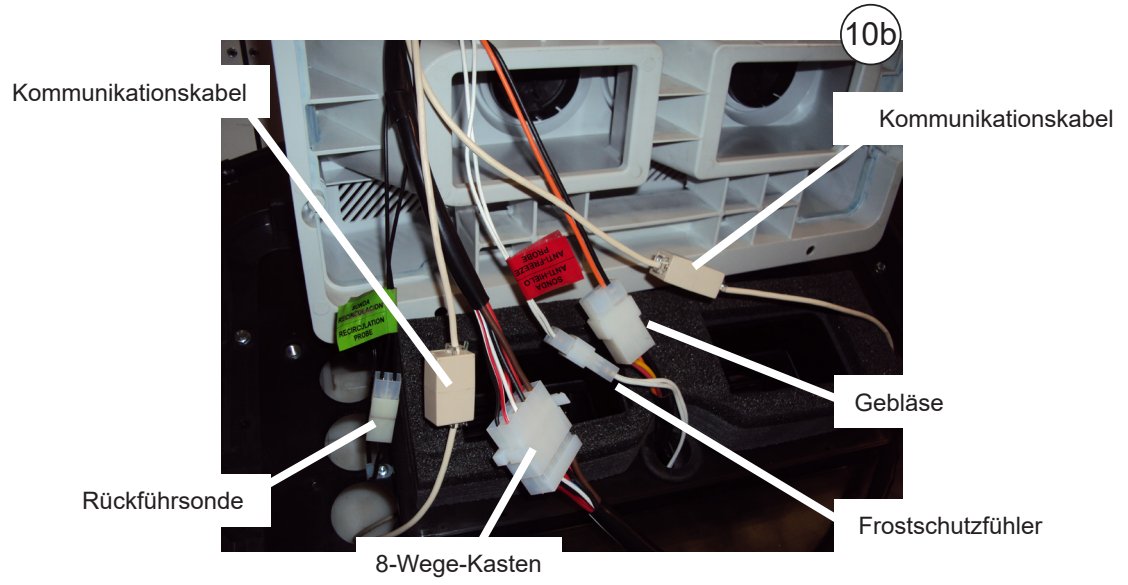

11

Innere Luftverteiltertafel an den vorgenannten Stiftschrauben mit jeweils (1) Breitflansch-Unterlegscheibe M6 und (1) Mutter M6 anbringen. Muttern anziehen, bis die Führung der inneren Luftverteiltertafel am oberen Schaumgummi der Anlage anschlägt.

Wichtiger Hinweis: Die Führung der inneren Luftverteiltertafel muss am oberen Schaumgummi der Anlage anschlagen, damit keine Luft austreten kann.

Darauf achten, dass die Kabel nicht zwischen Führung und Schaumgummi der Gerätegrundplatte eingeklemmt werden.

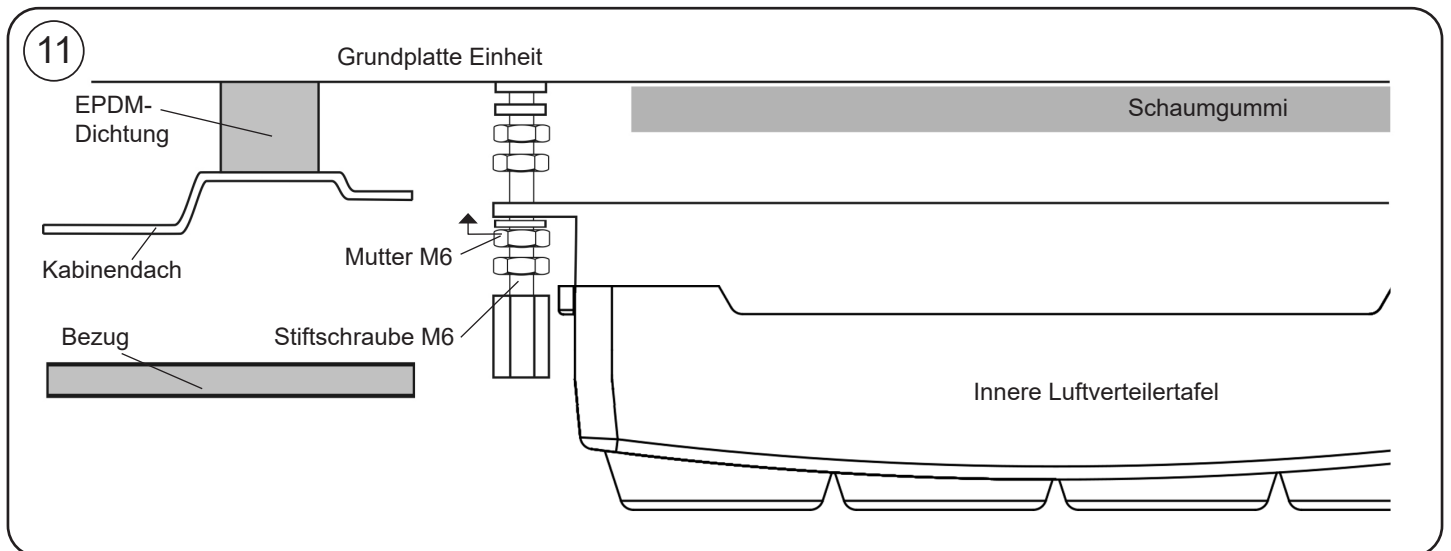

12

Mutter aus Punkt 10a anziehen, bis diese an das Oberteil der Luftverteiltertafel stößt.

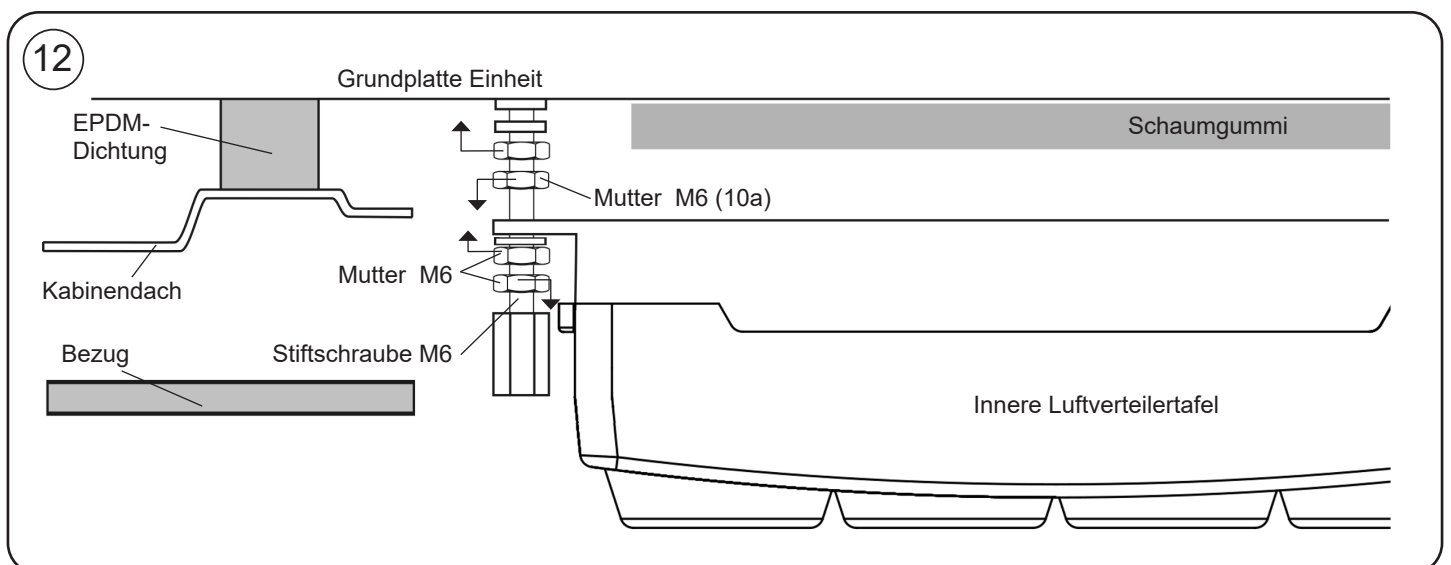

13

Die Konsole aufsetzen und das Gerät an der am besten geeigneten Stelle des Kabinendachs zentrieren. Nach der Zentrierung die Konsole für die nachfolgende Montage abnehmen.

14

Die Halterungen durch Anziehen der Muttern befestigen, bis die EPDM-Dichtung (**Punkt 4a**) des Geräts zwischen 3 und 6 mm komprimiert wird; es sollte mit einer Dicke zwischen 19 und 22 mm sein

Wichtiger Hinweis: Um das Eindringen von Wasser in die Kabine zu verhindern, die die Verbindung der EPDM-Dichtung mit der Grundplatte des Compact wie in **Schema** gezeigt überprüfen.

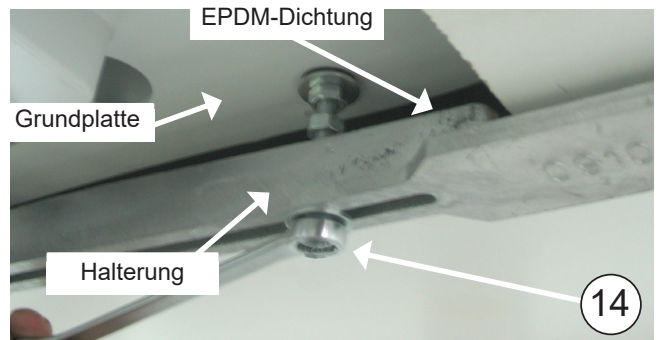
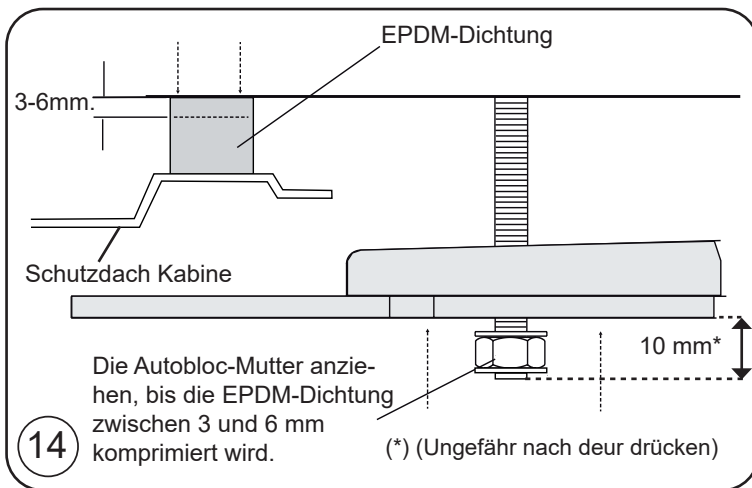

15

Die Muttern (4) M8 anziehen, um sie an der Grundplatte zu befestigen.



16

Eine Mutter M6(A) hinter der Befestigungsmutter der inneren Luftverteiltertafel an allen Stiftschrauben anbringen. Sechskant-Verbindungenmuttern M6 eindrehen, bis sie bei Fahrzeugen mit Kabine Super Space Cab 1 mm über dem Bezug heraus steht und sich bei allen übrigen Fahrzeugen 10 mm unter dem Bezug befinden. Muttern M6 (A) dieses Punkts herausschrauben, bis sie an die Hexagonalschrauben anstoßen und gegen diese anziehen.

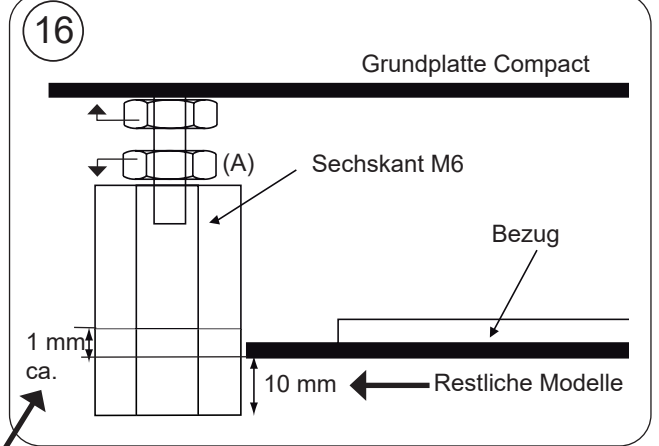

Super Space Cab



Restliche Kabinen



Kabine Super Space Cab

16

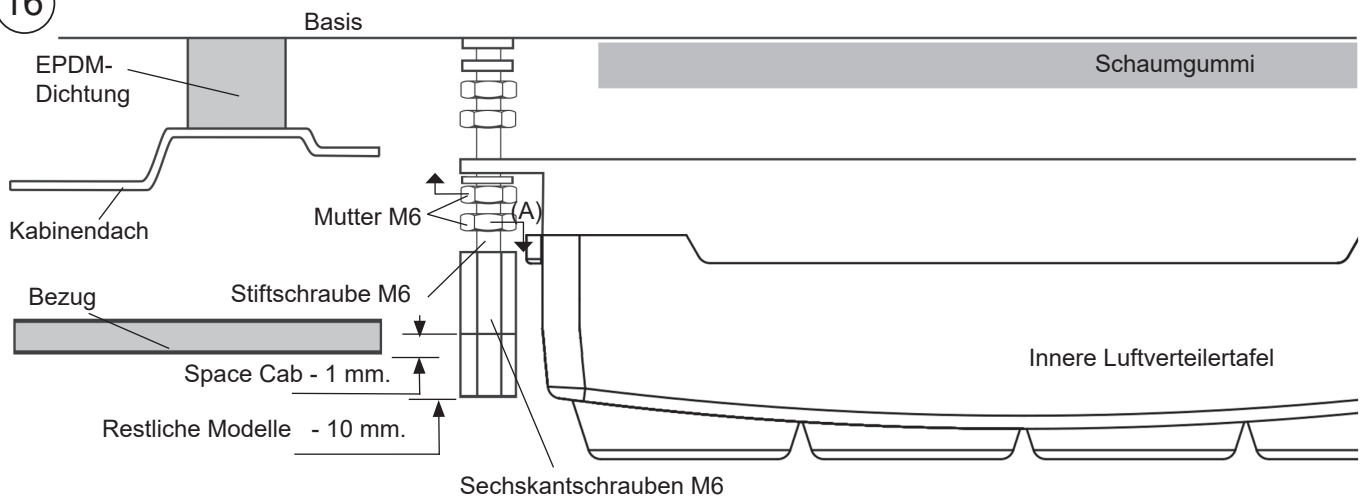

17 Die Konsole anhand von (4) Inbusschrauben M6/100x15 anbringen.



18 Die Köpfe der Inbusschrauben (4) M6/100x15 mit Kunststoffkappen M6 abdecken.



Explosionsansicht bis zur befestigung der befestigungsauflagen

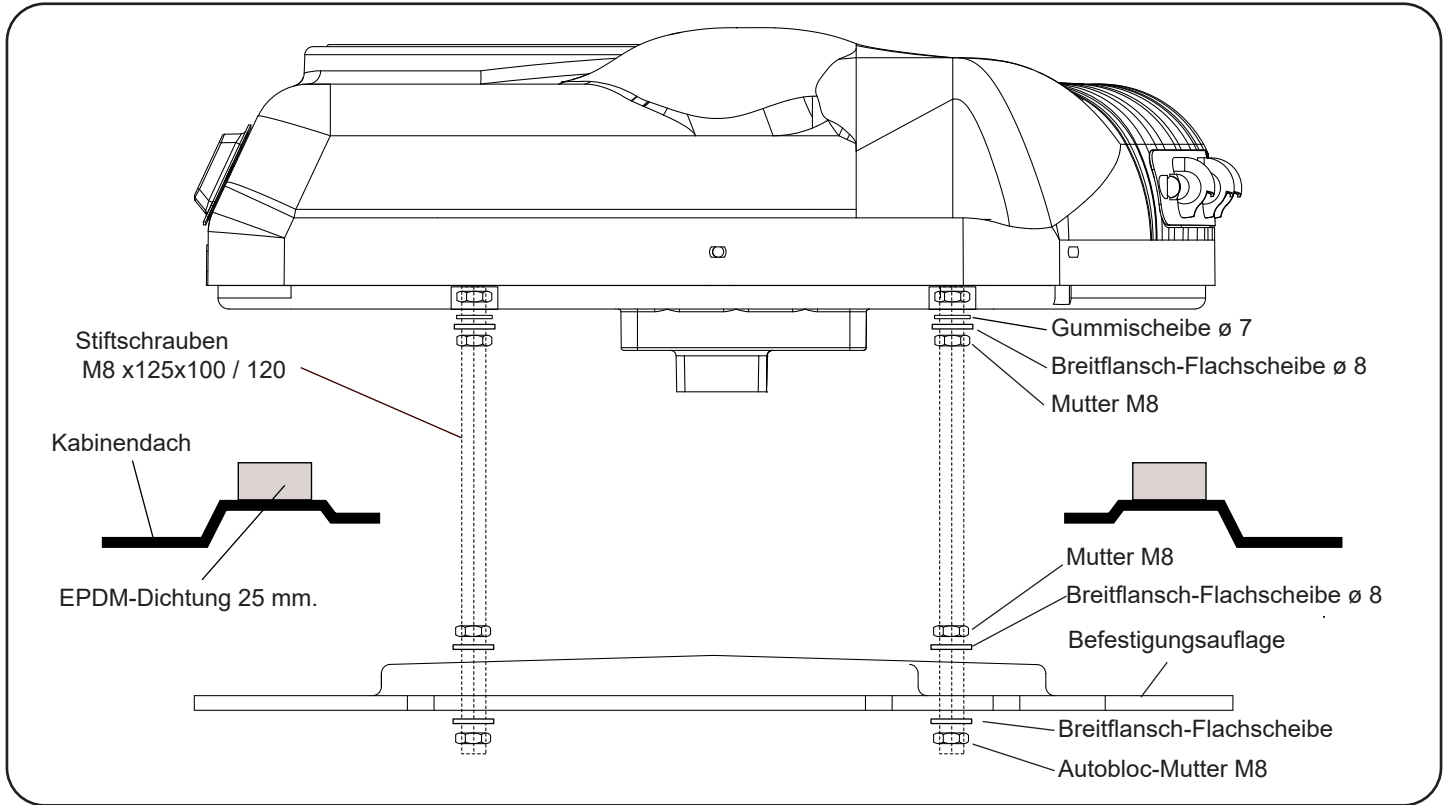

Explosionsansicht bis zur befestigung der konsolen

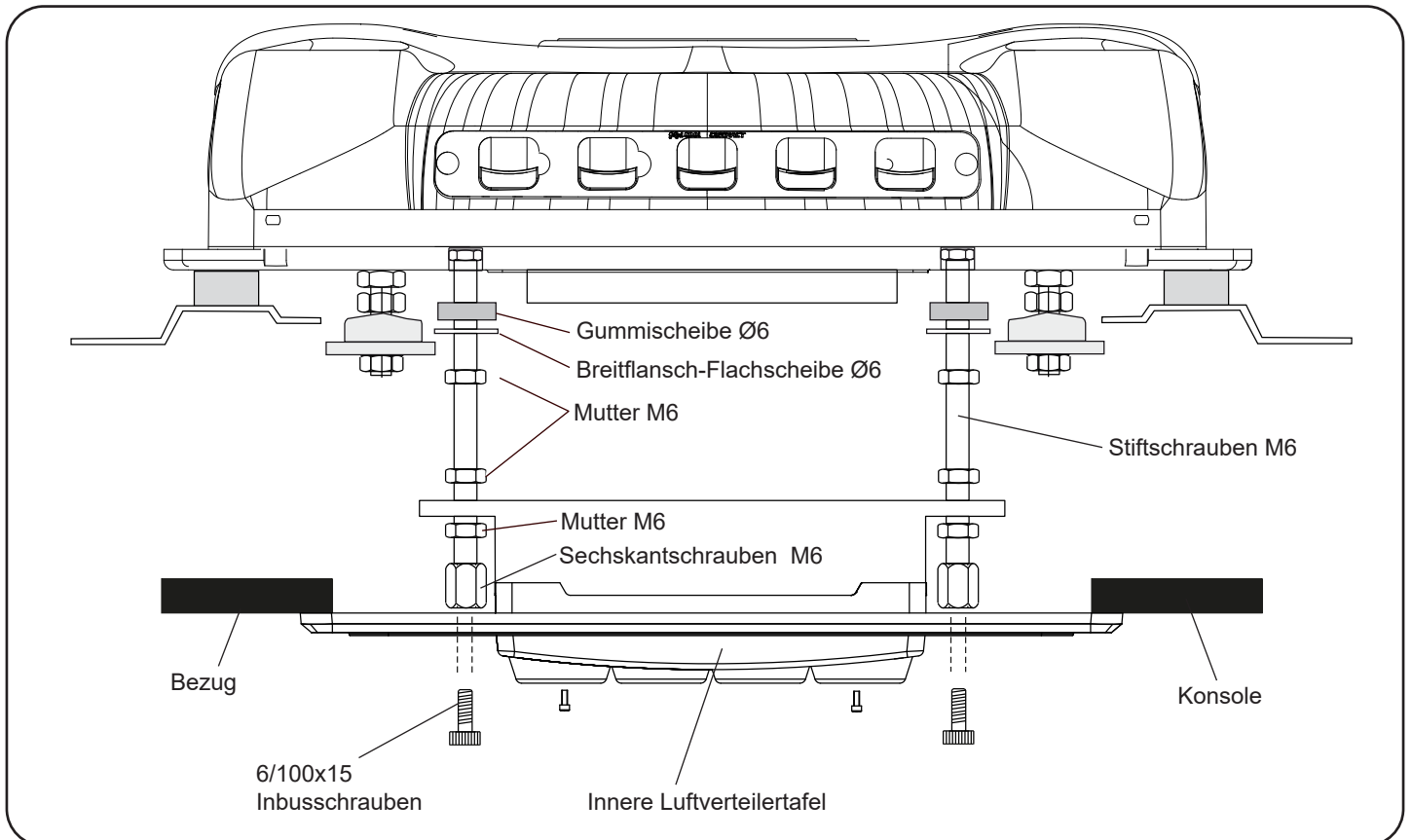

Ausführliche Anleitung für die Installation der Spannungsversorgung

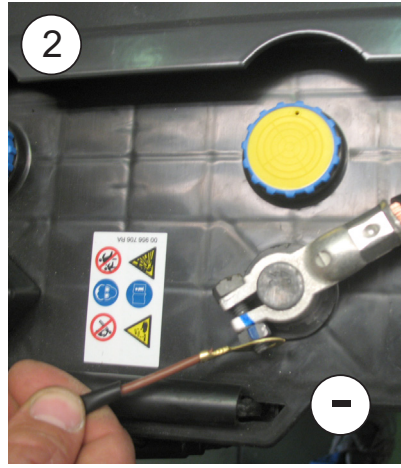
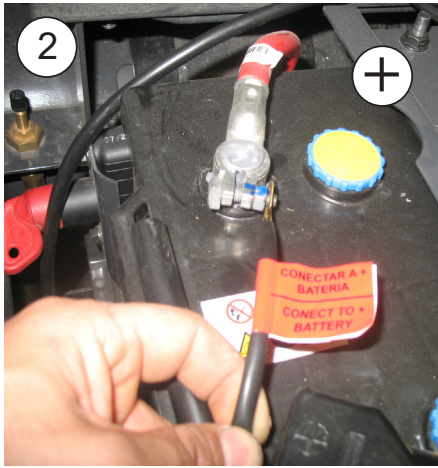
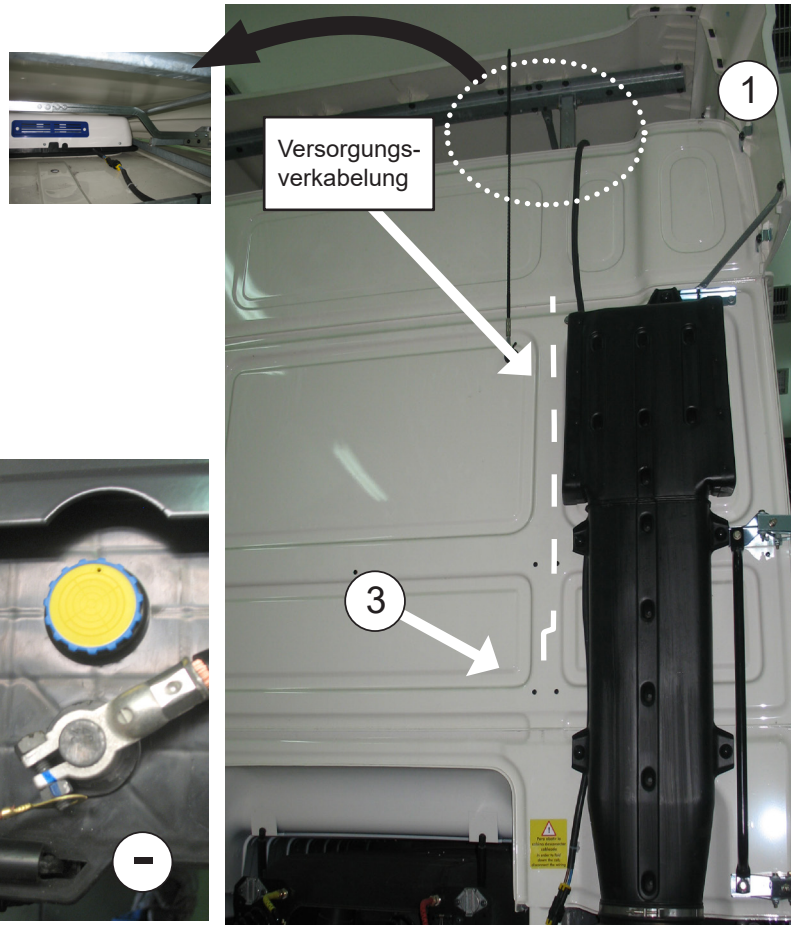
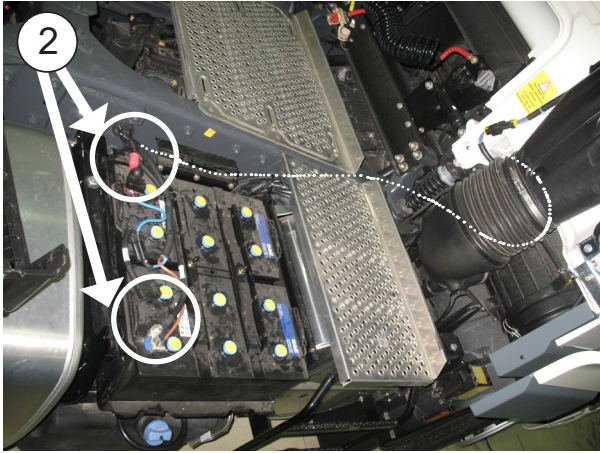

- 1- Oberes Stromversorgungskabel an die Rückseite des Geräts anschließen und um die Kabinenrückseite führen. Dabei die Kunststoffhalter ankleben und mit den Kabelbindern fixieren.
- 2- Unteres Stromversorgungskabel an die Batterie anschließen. Dieses durch den ursprünglichen Kabeldurchgang, befestigt mit Kabelbindern, hin zur Kabinenrückseite führen, um es mit dem oberen Stromversorgungskabel zu verbinden **!!BEIM VERBINDEN DER KABEL, AUSREICHEND ABSTAND LASSEN, UM EINEN DURCH DIE KABINENBEWEGUNGEN BEDINGTEN BRUCH ZU VERMEIDEN!!**

WICHTIG: Aufgrund der Komplexität des elektronischen Regelsystems des Geräts, muss der Stromanschluss direkt an der Fahrzeugbatterie erfolgen.

WICHTIG: Zur Inbetriebsetzung Bedienerhandbuch heranziehen.

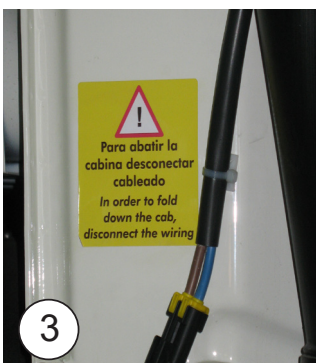

- 3- Gefahrenkleber an Kabelverbindung und Kabinenhebevorrichtung anbringen.



Elektrische Verkabelung

WICHTIGER WARHNHINWEIS!

Darauf achten, dass die Polaritäten beim Anschluss der Stromversorgung an das Gerät nicht vertauscht werden. Ist dies der Fall, schaltet sich die Elektroniktafel nicht ein, das Gerät funktioniert nicht und es kommt zu irreparablen Schäden an den Kompressormodulen.

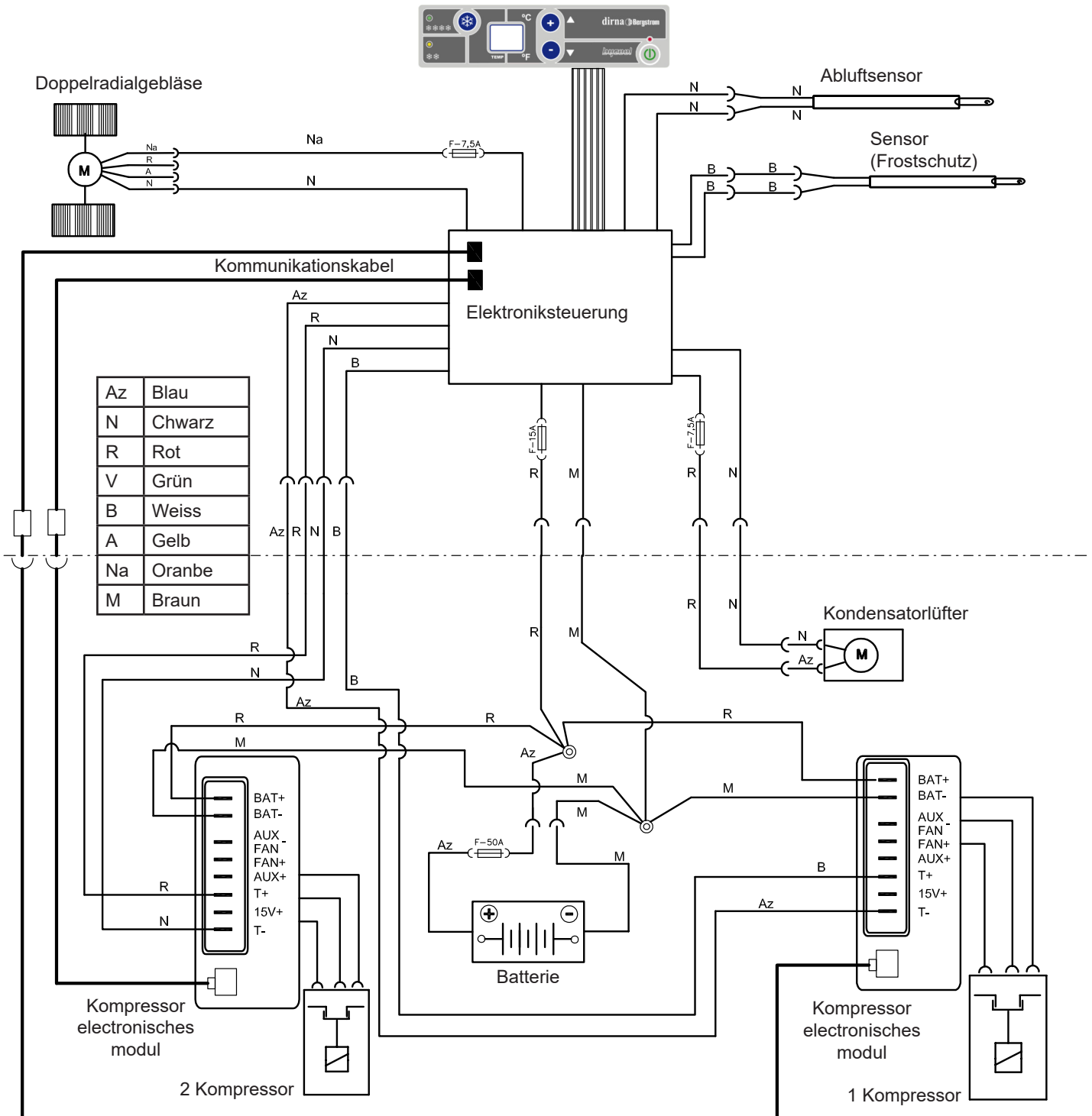

Suggerimenti per il montaggio

- Prima di cominciare il montaggio, leggere attentamente le istruzioni e rispettarle nel corso dello stesso.
- Usare gli attrezzi più adatti ad ogni operazione.

Elettricità

- Scollegare la chiave di contatto.
- Scollegare la batteria prima di cominciare il montaggio.
- Assicurarsi di avere effettuato correttamente l'installazione e il collegamento dei componenti elettrici.

Attenzione

Se durante il montaggio si inclina l'impianto, prima di rimetterlo in funzione occorre attendere almeno 60 minuti dal momento in cui è di nuovo in posizione orizzontale.

Attenzione

Quando si installa l'impianto di aria condizionata sul tettuccio, bisogna proteggere la parte superiore della cabina con uno straccio o una coperta per evitare eventuali graffi. Per l'installazione del **Compact**, tenere presente che normalmente le cabine munite di oblò dispongono di una struttura abbastanza solida per sostenere il peso dell'impianto. Tuttavia, se così non fosse e se fosse necessario tagliare il tettuccio, o se in presenza di oblò la struttura non fosse abbastanza rigida (se fosse di fibra, plastica, ecc.), è responsabilità dell'installatore decidere se occorre rinforzare il tettuccio per evitare qualsiasi deformazione, rottura o penetrazione d'acqua, ecc., prendendo le misure necessarie per evitarlo.



Attrezzi

- Kit di chiavi Torx
- Kit di chiavi Allen
- Chiave fissa 10, 13, 14
- Forbici
- Metro a nastro







Documentazione allegata

Istruzioni di montaggio	1001217173
Guida dell'utente	1001218019
Soluzione dei problemi	1001218025
Garanzia	220AA10017

Simbologia

-  Fragile
-  Attenzione alle mani
-  Tensione elettrica pericolosa

Avvertenze

-  L'installatore deve essere in possesso della formazione necessaria in materia di aria condizionata per veicoli.
-  **dirna, s.a.** declina ogni responsabilità per danni o rotture derivanti dall'errata installazione o dall'errato uso dell'impianto o da sostituzioni o modifiche effettuate senza la necessaria autorizzazione per iscritto.
-  **Impianto precaricato con gas refrigerante, R-134a. (Non manomettere il circuito di gas refrigerante).**
-  Vedi la **procedura di garanzia** del prodotto in **Diagnosi dei problemi**.
-  Vedi la **Guida dell'utente** dell'impianto per il corretto funzionamento del telecomando e del pannello di controllo.
-  I seguenti documenti devono essere consegnati all'utente una volta conclusa l'installazione: **Guida dell'utente, Garanzia e Diagnosi dei problemi**.

 Prima di iniziare il montaggio, installare la griglia sull'entrata anteriore dell'aria.



1 Se il veicolo dispone di spoiler, richiedere il kit 0911020014.

2 Smontare il coperchio dell'oblò, gli elementi di fissaggio e consegnarli al cliente (*).

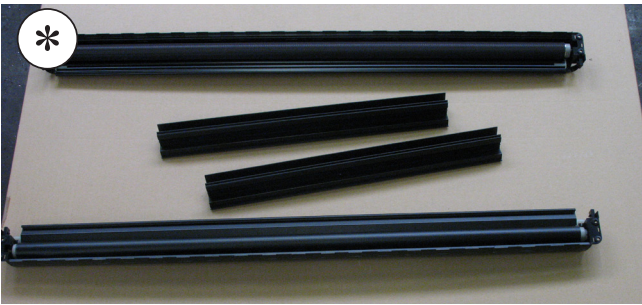

3 Eliminare i residui di adesivo dalla superficie superiore della cabina prima di incollare la guarnizione EPDM.

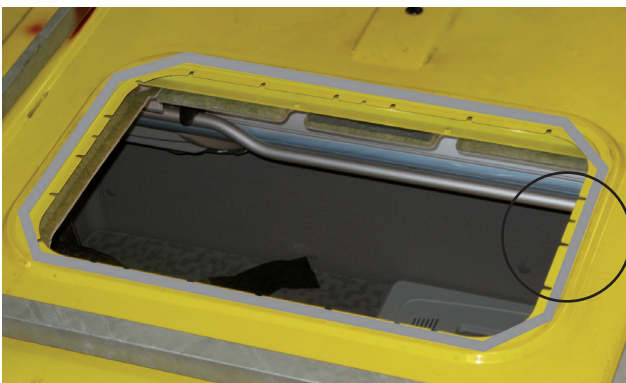

4 Se lo spoiler presenta una barra centrale, tagliarla lungo la zona con i punti per poter installare l'impianto.



4a Incollare la guarnizione EPDM intorno al foro dell'oblò (vedi particolare per tagliare i bordi).

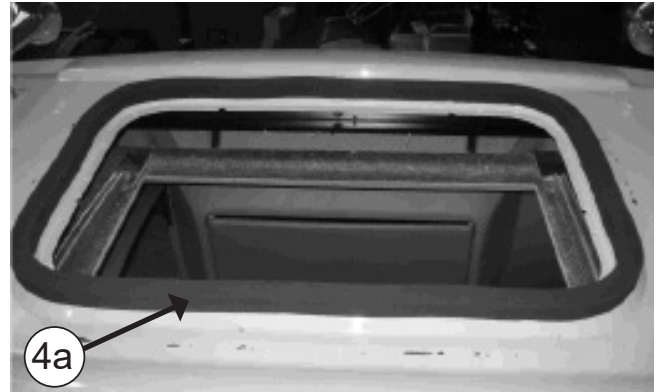

 **COME TAGLIARE LA GUARNIZIONE EPDM PER EVITARE INFILTRAZIONI NELLA CABINA**

A- Incollare la guarnizione mantenendo una protezione di carta di 100 mm su ogni lato.

B- Rimuovere i due pezzi di carta.

C- Incollare premendo su entrambe le estremità.

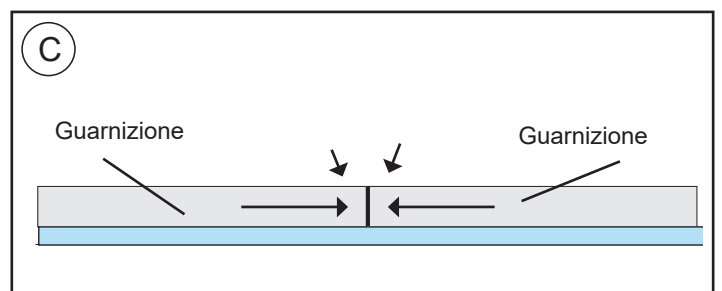
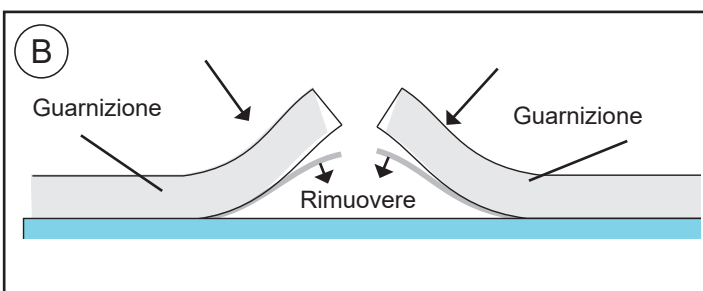
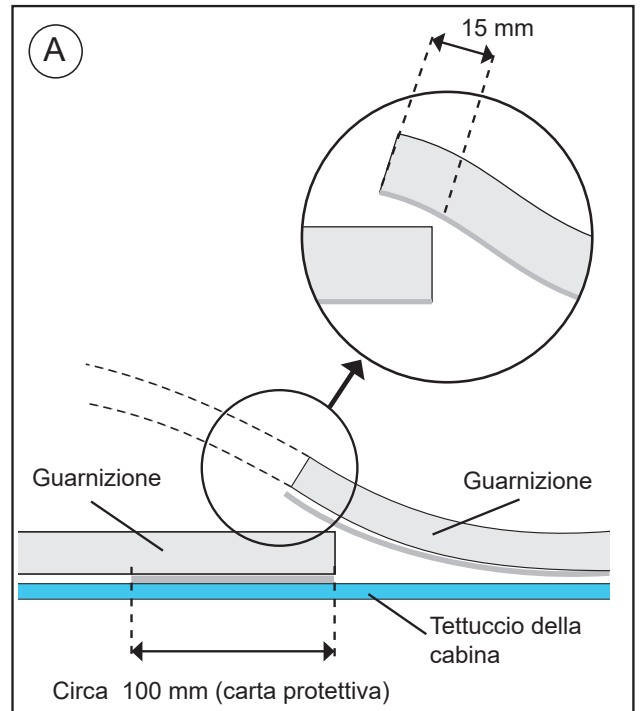

5

ESTERNO CABINA:

Inserire il Compact nel vano.

Attenzione! Quando si posiziona l'impianto sul vano del tettuccio apribile, controllare che le uscite di scarico non siano ostruite dalla guarnizione EPDM.

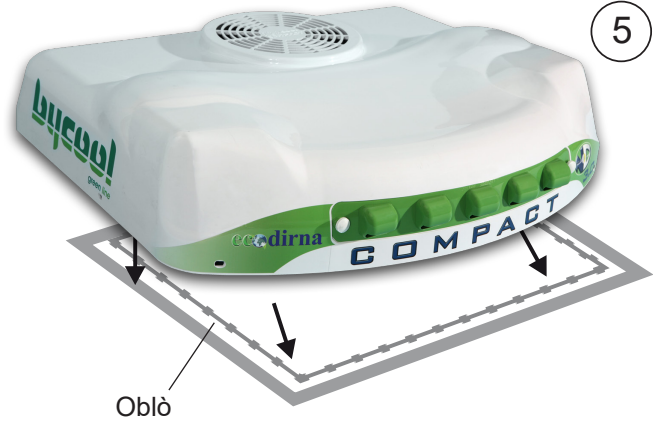

6

Posizionare il canalizzatore di gommapiuma con la parte più morbida sulla base dell'impianto.

Attenzione: A seconda della cabina, può essere necessario usare i (2) canalizzatori in dotazione per la completa adesione del pannello di distribuzione dell'aria ai medesimi.



7

INTERNO CABINA:

Avvitare di circa 5 mm le (4) viti prigioniere da 8/125x70, 100 o 120 mm, a seconda della distanza (maggiore o minore) dall'impianto finché, posizionando i supporti di fissaggio, le viti non sporgono di 20 mm dagli stessi.

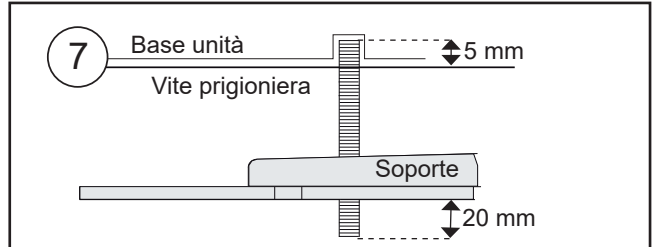

8

Inserire (8) rondella di gomma Ø 7, (1) rondella piana Ø 1 a testa larga, (2) dadi M8 e (1) rondella piana Ø 8 a testa larga, su ciascuna vite prigioniera precedente, seguendo questo ordine.

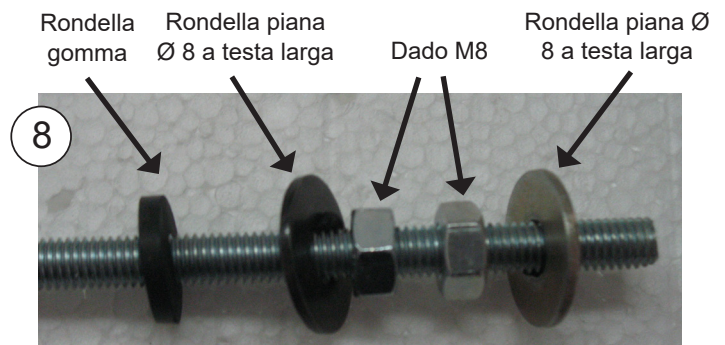

8a

Fissare i supporti di fissaggio (2), con una rondella (1) e un dado autobloccante (1) M8, senza stringere.

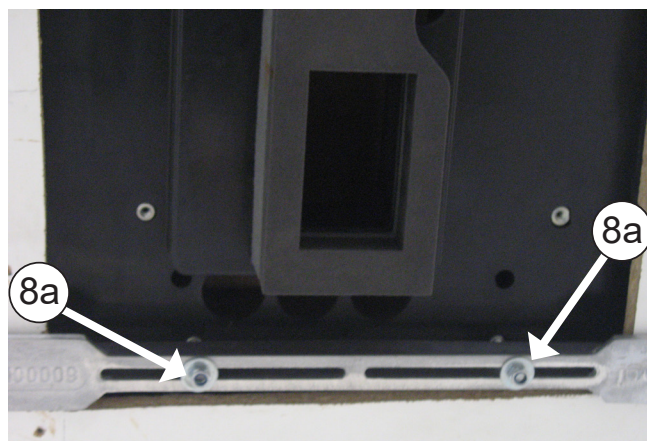

9

Avvitare di 10 mm i perni (4) M6 x 80, dove indicato distanza (A) segun nella a figura 16.

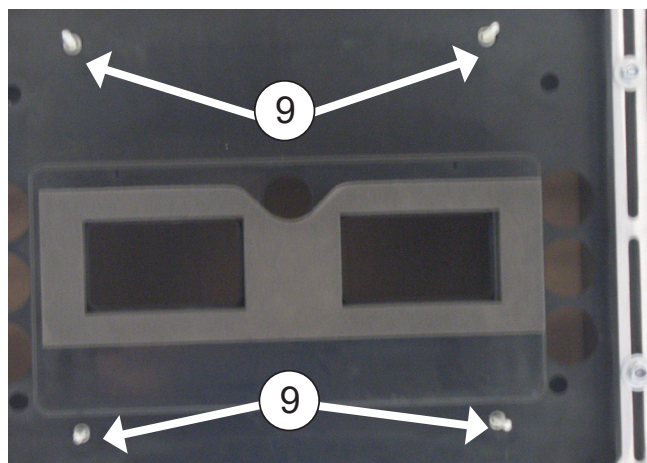
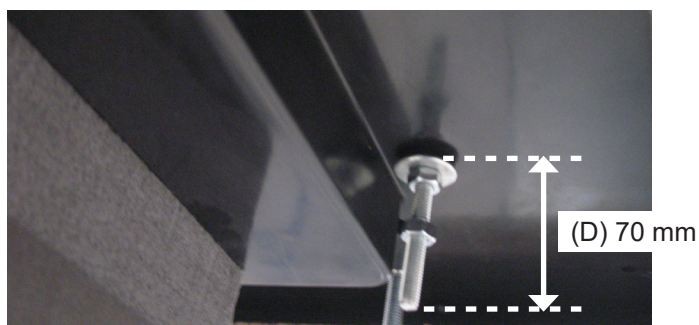

10

Inserire (1) rondella Ø 6 di gomma, (1) rondella piana Ø 6 a testa larga e (1) dado M6 su ogni vite prigioniera M6. Quindi stringere il dado fino a premere leggermente la rondella di gomma.

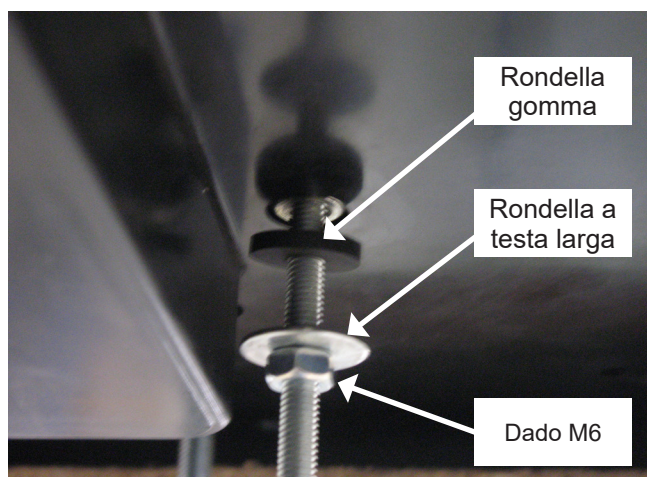

10a

Inserire il dado (1) M6 **senza stringere** in ogni vite prigioniera.

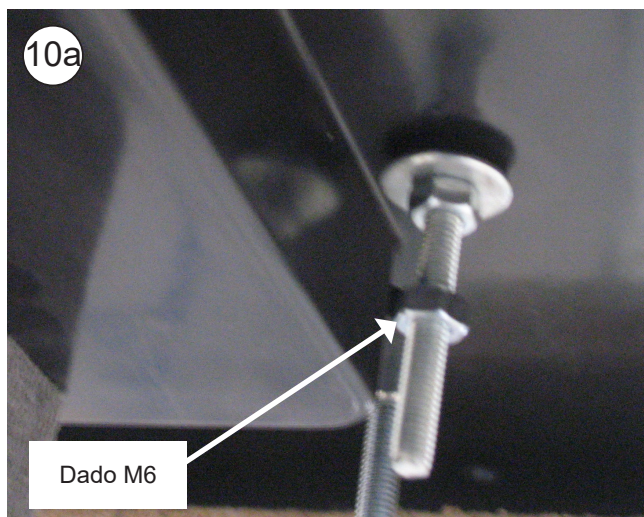

Dado M6

10b

Tra la base e il pannello interno di distribuzione dell'aria, collegare (2) scatole a due vie del sensore antigelo (cavi bianchi) e del sensore dell'aria di ritorno (cavi neri), la scatola a 4 vie del ventilatore, (2) cavi di comunicazione e la scatola a 8 vie del cablaggio di connessione con il controllo elettronico.

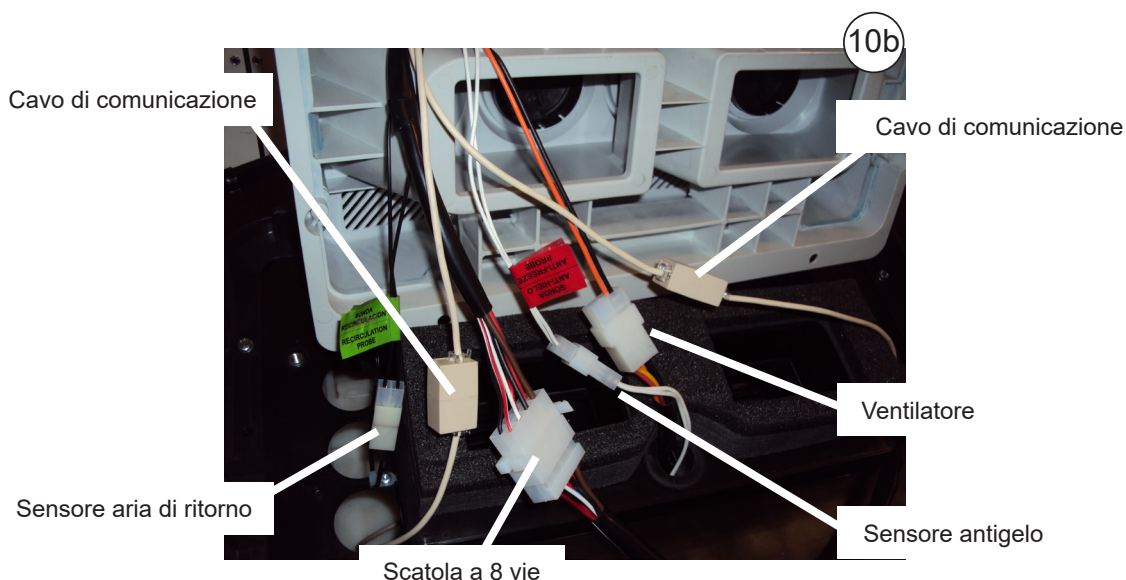

11

Posizionare il pannello interno di distribuzione dell'aria sulle viti prigioniera anteriori con (1) rondella M6 a testa larga e (1) dado M6 su ogni vite prigioniera. Stringere i dadi finché il canalizzatore del pannello interno di distribuzione dell'aria non è a battuta sulla gommapiuma superiore dell'impianto.

Nota bene: il canalizzatore del pannello interno di distribuzione dell'aria deve essere a battuta sulla gommapiuma superiore dell'impianto per evitare perdite d'aria.

Evitare che i cablaggi restino impigliati tra il canalizzatore e la gommapiuma sulla base dell'impianto.

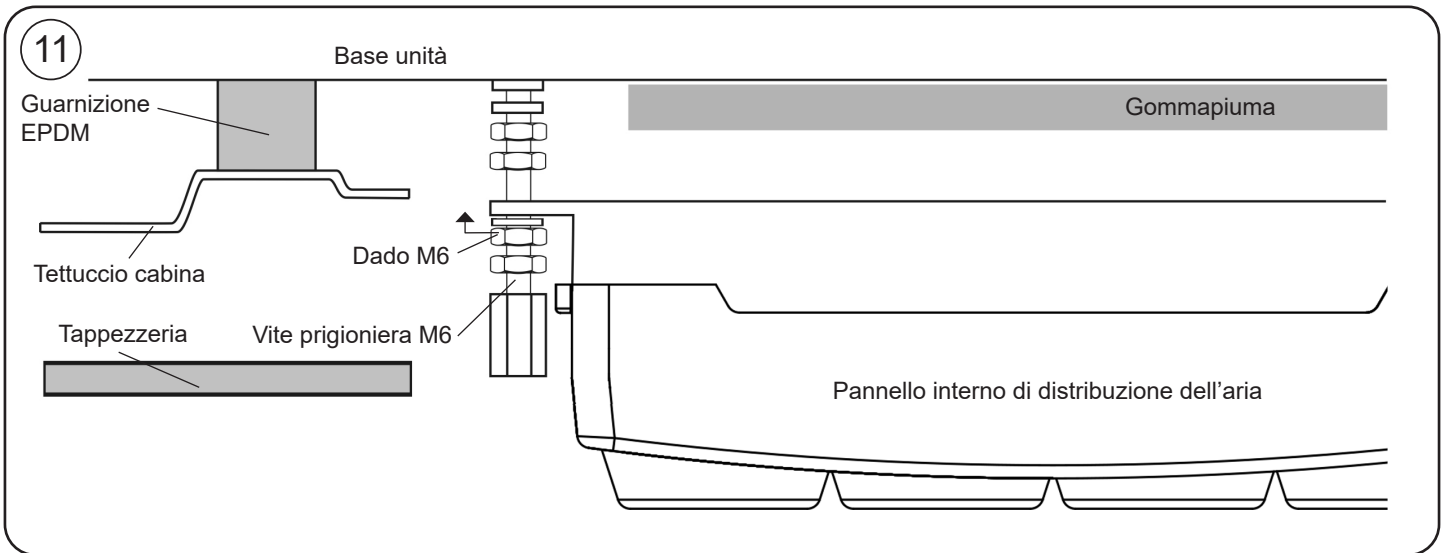

12

Stringere il dado del punto **10a** fino a battuta con la parte superiore del pannello interno di distribuzione dell'aria.

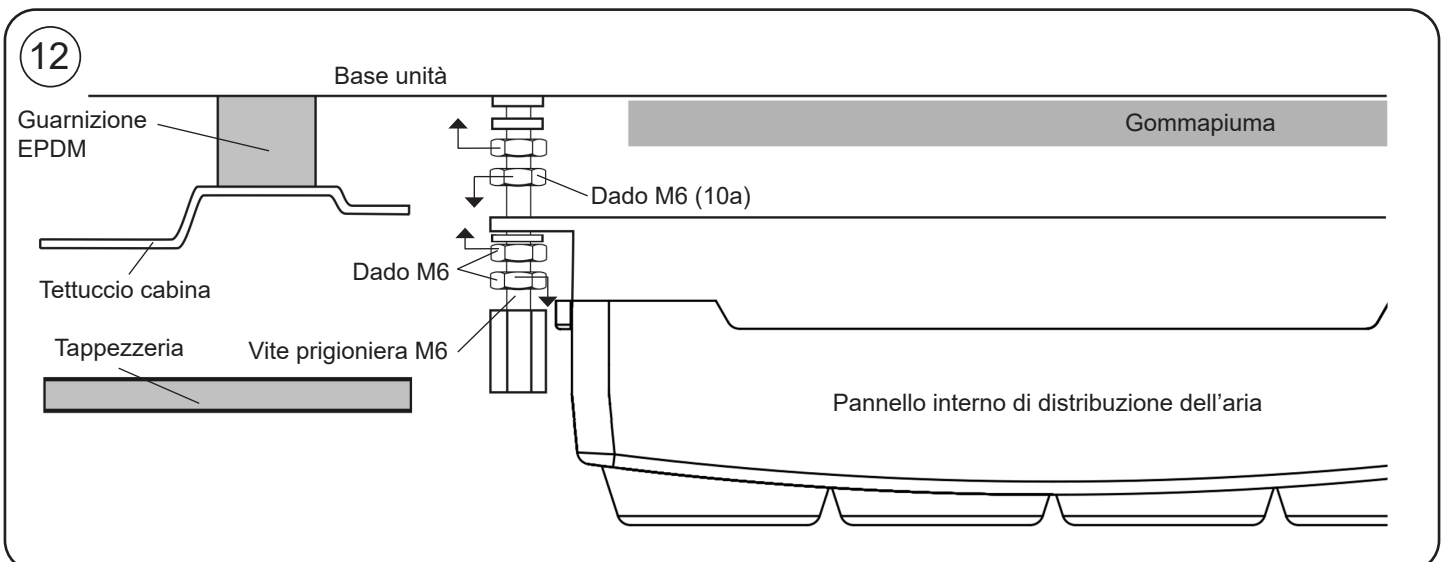

13

Inserire la consolle e centrare l'impianto nella parte più adatta del tettuccio della cabina. Una volta centrato, rimuovere la consolle per la successiva installazione.

14

Fissare i supporti stringendo i dadi fino a comprimere, tra 3 e 6 mm, la guarnizione EPDM (Punto 4a) dell'impianto; deve rimanere con un spessore tra 19 e 22 mm.

Nota bene: Per evitare che infiltrazioni d'acqua nella cabina, verificare il serraggio della guarnizione EPDM con la base Compact base, come illustrato nel Diagramma.

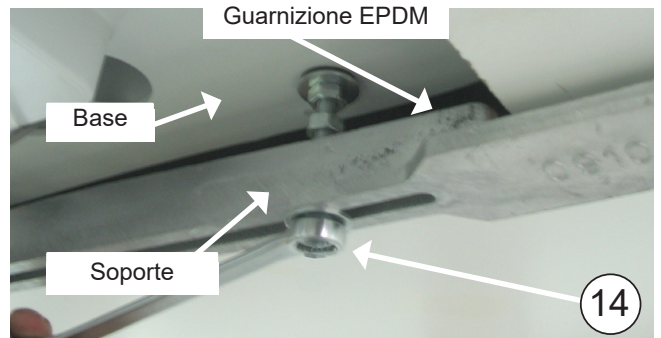
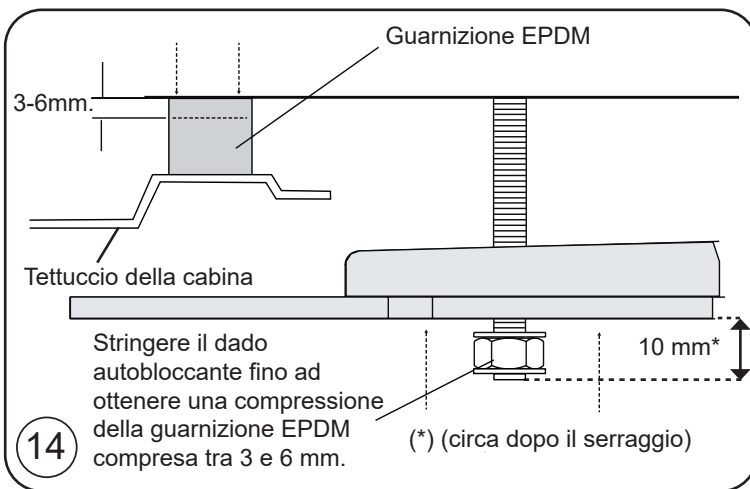

15

Stringere i dadi (4) M8 per fissare a (4) l'unità base.

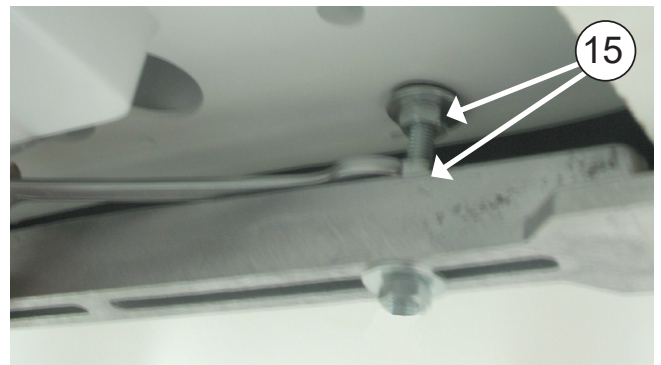

16 Inserire il dado M6 (A) sul dado di fissaggio del pannello interno di distribuzione dell'aria su ogni vite prigioniera. Inserire i perni esagonali M6 e avvitarli fino a lasciarli a 1 mm al di sopra della tappezzeria nei veicoli con cabina Super Space Cab e 10 mm al di sotto della tappezzeria negli altri veicoli. Svitare i dadi M6 (A) di questo punto fino a battuta con i perni esagonali e stringerli contro gli stessi.

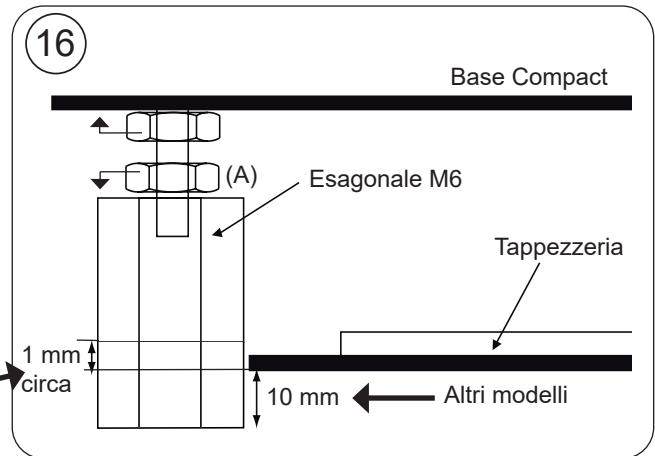

Super Space Cab



Altre cabine



Cabina Super Space Cab

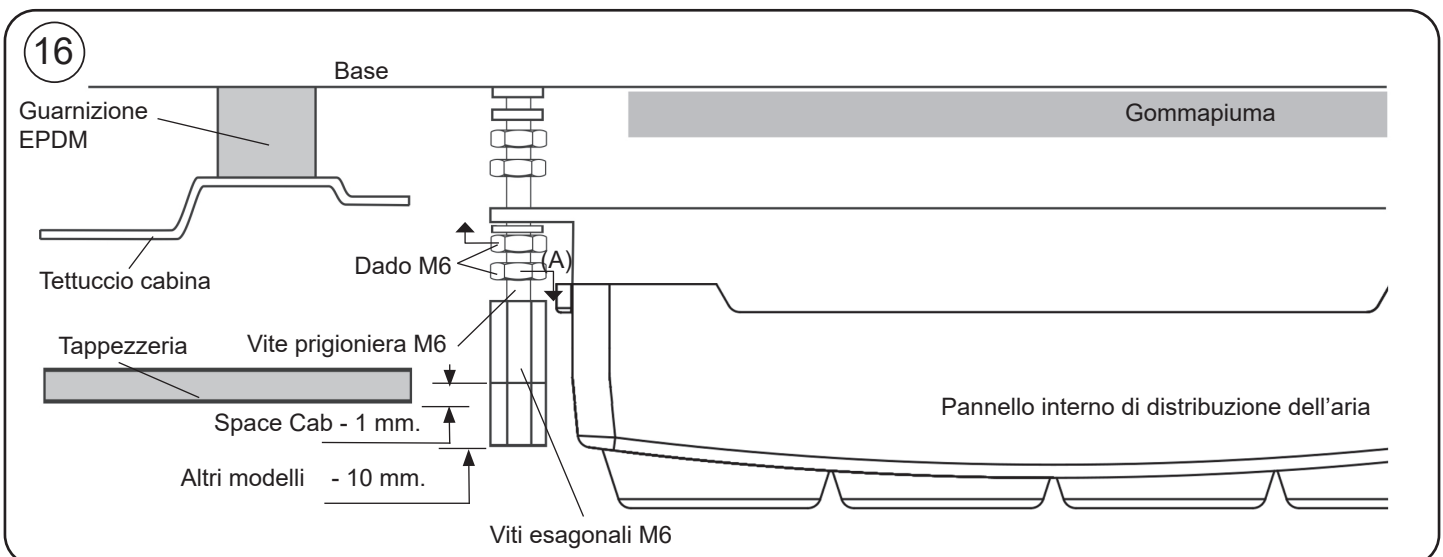

17 Posizionare la consolle usando (4) viti a brugola M6/100x15.



18 Collocare sugli stessi le decorazioni rotonde di plastica M6.



Esplso fino al fissaggio dei supporti di fissaggio

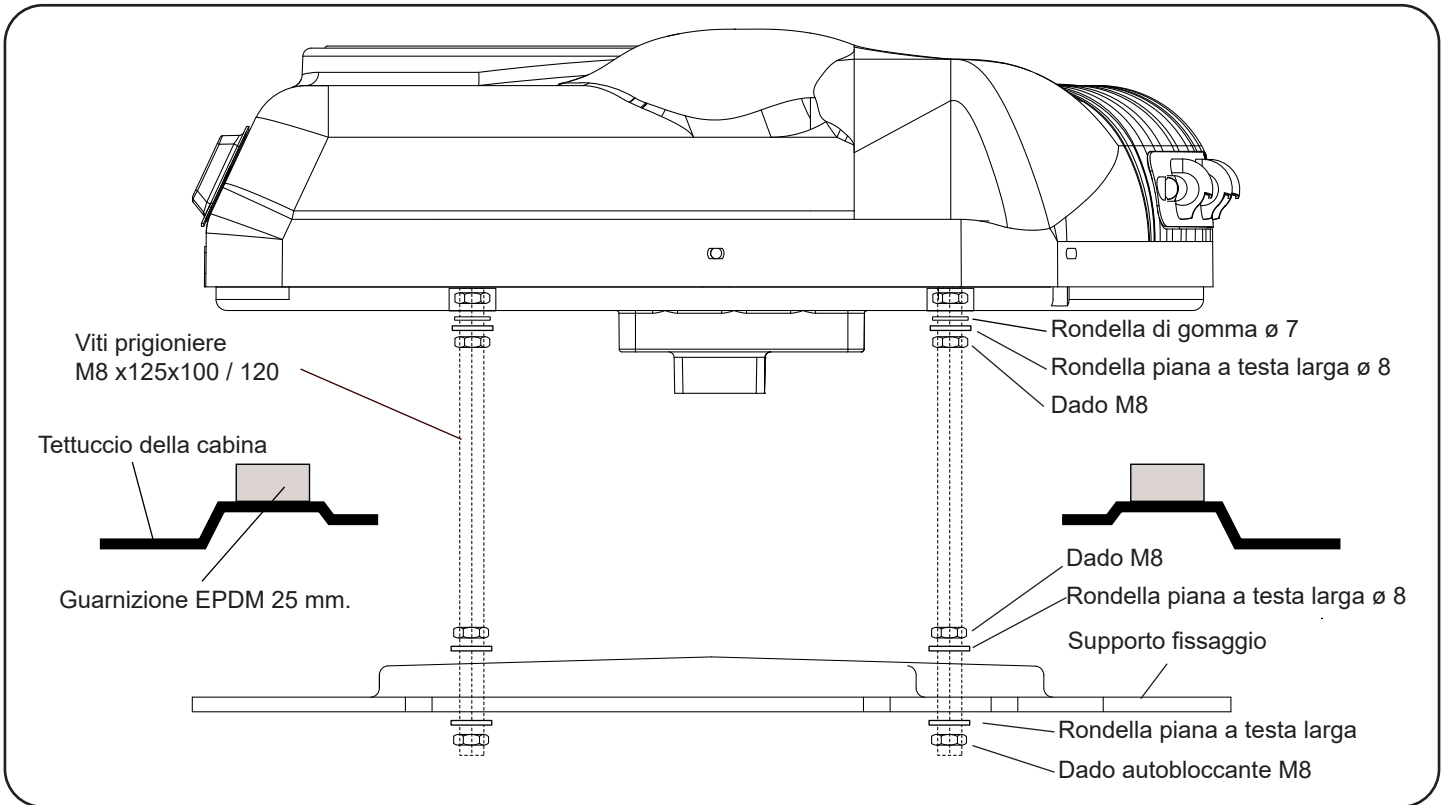

Esplso fino al fissaggio della consolle

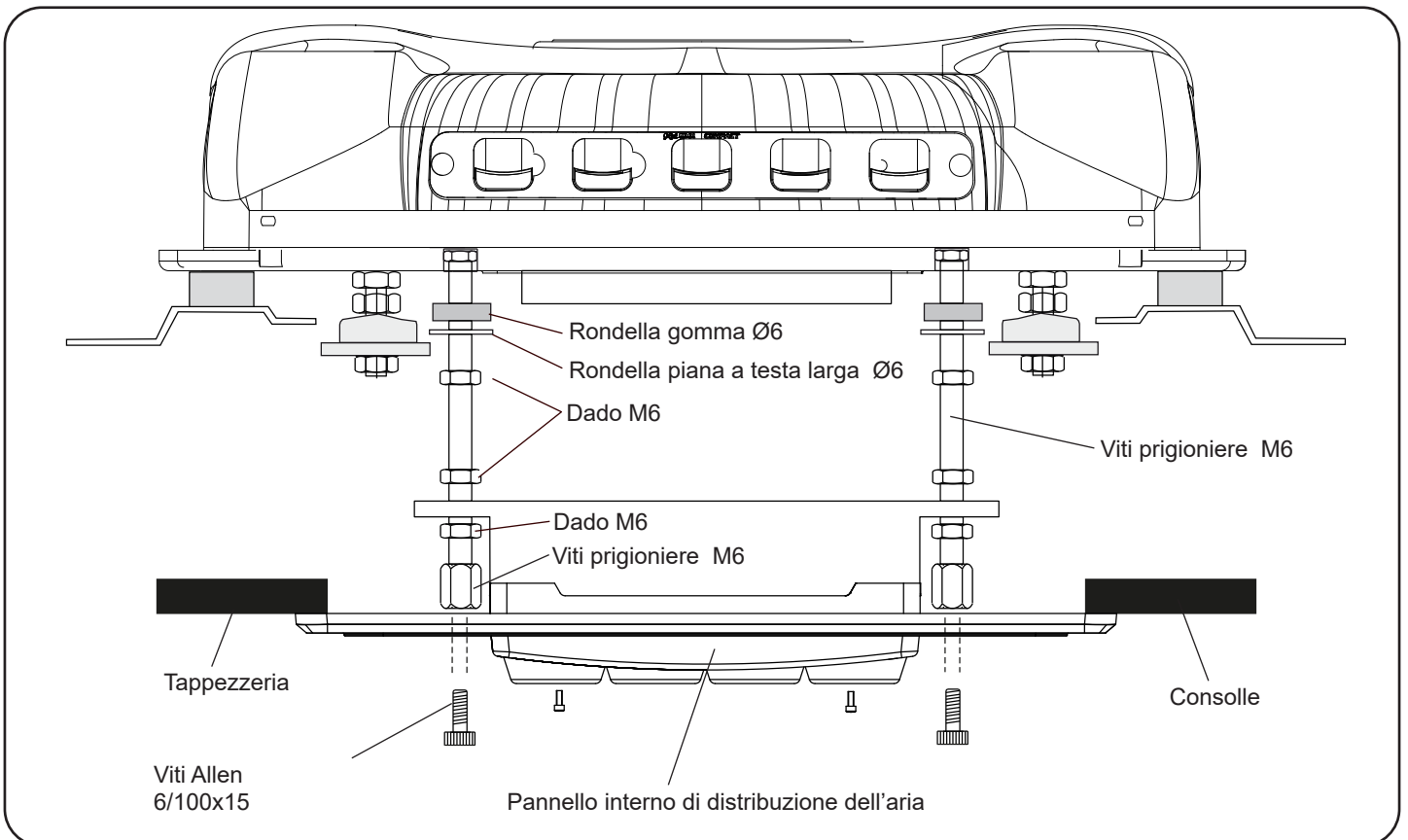

Istruzioni dettagliate Sull'installazione del cablaggio di alimentazione

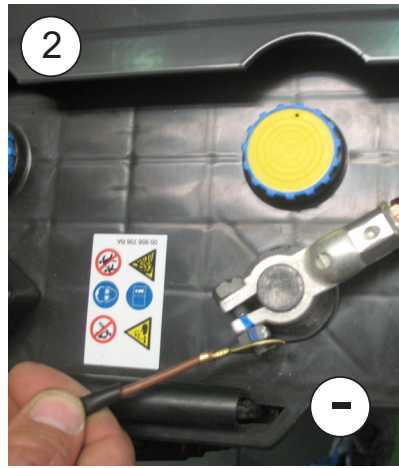
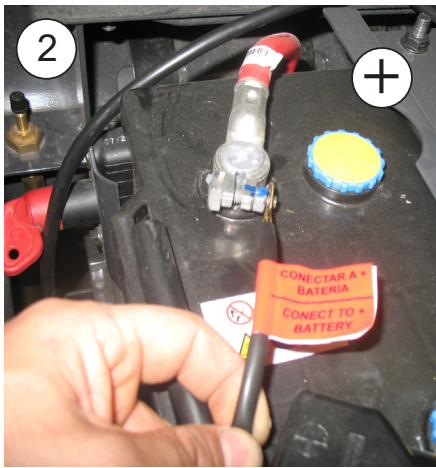
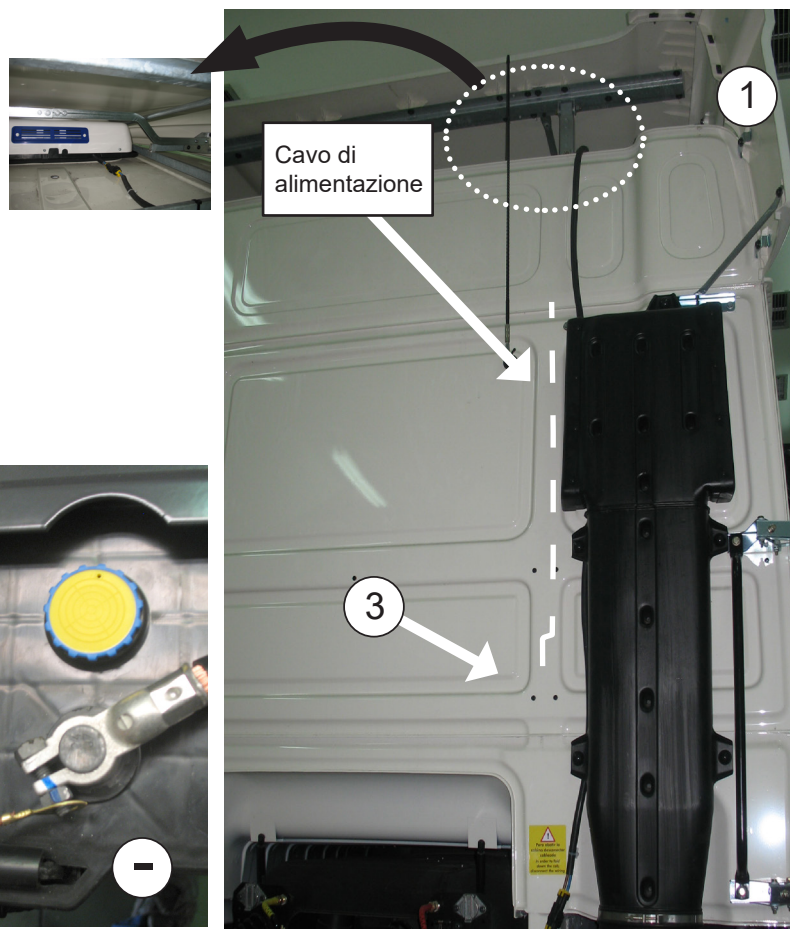
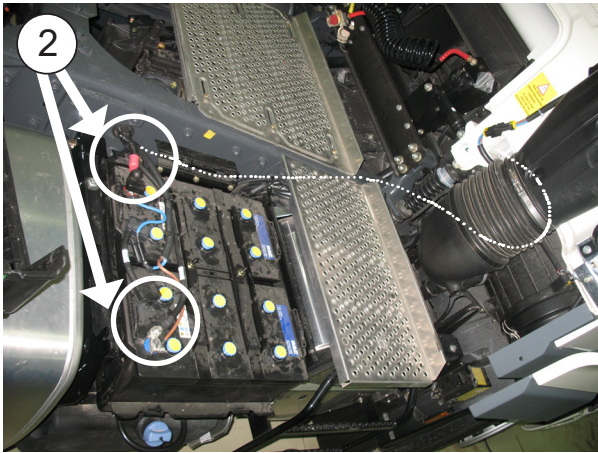

- 1- Collegare il cavo di alimentazione superiore nella parte posteriore dell'impianto e farlo scorrere lungo la parte posteriore della cabina incollando i supporti di plastica e fissandolo con le flange.
- 2- Collegare il cavo di alimentazione inferiore alla batteria, facendolo scorrere lungo il passaggio originale dei cablaggi, fissato con le flange, verso la parte posteriore della cabina, per effettuare il collegamento con il cavo di alimentazione superiore. **QUANDO SI COLLEGANO I CABLAGGI, RISPETTARE LA DISTANZA NECESSARIA PER EVITARNE LA ROTTURA CON I MOVIMENTI DELLA CABINA!**

NOTA BENE: Dato il complesso sistema di regolazione elettronica dell'impianto, la corrente deve essere prelevata direttamente dalla batteria del veicolo.

NOTA BENE: Per la messa in funzione, vedi il Manuale dell'utente.

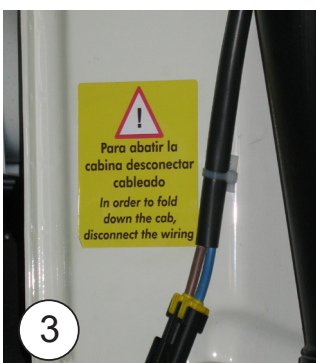

- 3- Apporre gli adesivi indicanti pericolo sulla giunzione del cablaggio e sul dispositivo di sollevamento della cabina.



Cablaggio elettrico

AVVISO IMPORTANTE!

Fare attenzione a non invertire le polarità effettuando la connessione dell'alimentazione all'impianto, altrimenti il quadro comandi non si accende, l'impianto non funziona e si potrebbero verificare danni irreparabili ai moduli dei compressori.

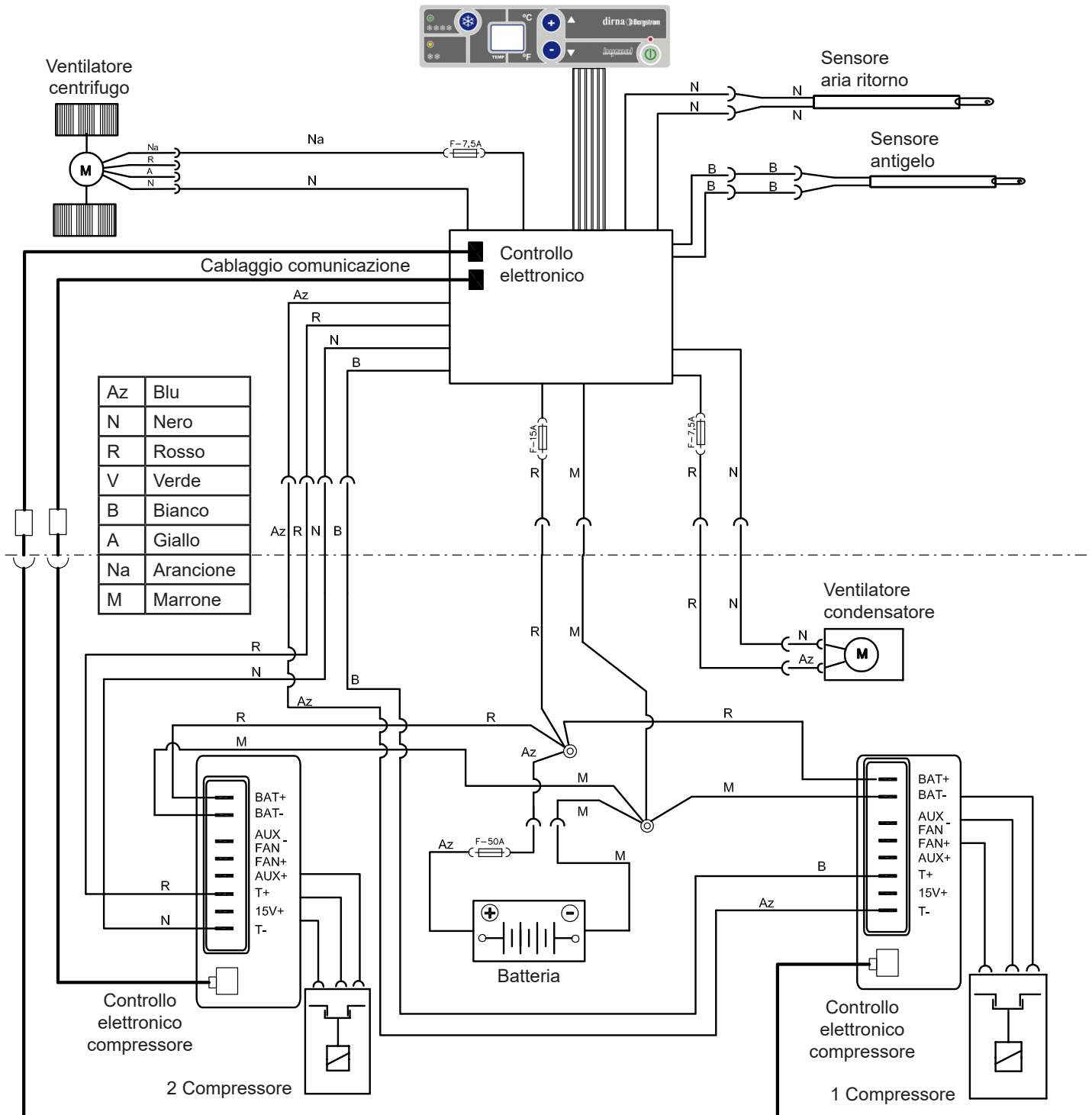

Ed:	01/02/2016
Md:	06/08/2019

b



Francisco Alonso, 6
28806 Alcalá de Henares, Madrid
SPAIN

Contact	Phone	Fax	E-Mail
Sales (Ventas Internacional)	+34 91 8770510	+34 91 8771158	sales@dirna.bergstrominc.com
Comercial Nacional	+34 91 8775841	+34 91 8836321	ventas@dirna.bergstrominc.com
Orders & Deliveries (Logística internacional)	+34 91 8775846	+34 91 8771158	export@dirna.bergstrominc.com
Orders & Deliveries (Logística nacional)	+34 91 8775840	+34 91 8836321	comercial@dirna.bergstrominc.com
Technical Assistance (Internacional)	+49 511 86679681	+49 511 86679710	technicalassistance@dirna.bergstrominc.com
Technical Assistance (Nacional)	+34 91 8775845	+34 91 883 6321	oblanco@dirna.bergstrominc.com

www.dirna.com

	ATENCIÓN:	Dirna Bergstrom se reserva el derecho de efectuar modificaciones en cualquier momento de los datos contenidos en esta publicación, por razones técnicas o comerciales.
	NOTE:	<i>For technical and commercial reasons, Dirna Bergstrom reserves the right to change the data contained in this brochure.</i>
	ATTENTION:	Dirna Bergstrom se réserve le droit d'effectuer à tout moment des modifications des données reprises sur cette publication, pour des raisons techniques ou commerciales.
	HIWEIS:	<i>Dirna Bergstrom behält sich vor, aus technischen oder kaufmännischen Gründen jederzeit Änderungen der Angaben dieser Veröffentlichung vorzunehmen.</i>
	ATTENZIONE:	Dirna Bergstrom si riserva il diritto di effettuare modifiche in qualsiasi momento ai dati contenuti in questa pubblicazione, per motivi tecnici o commerciali.