

bycool!
green line

COMPACT 1.4 DAF



Instrucciones de Montaje

Mounting Instructions

Instructions de Montage

Montageanweisungen

Istruzioni di Montaggio

ES Spanish

EN English

FR French

GE German

IT Italian

Recomendaciones Para el montaje

- Antes de iniciar el montaje leer las instrucciones y seguirlas durante el proceso de instalación.
- Usar las herramientas adecuadas para cada operación.

Electricidad

- Desconectar la llave de contacto.
- Desconectar la batería antes de empezar el montaje.
- Asegurar el conexionado de los componentes eléctricos, verificando su correcto encaje.

Atención

Si durante el montaje el equipo se inclina o se abate la cabina con el equipo montado, se deberá esperar un mínimo de 60 minutos, desde que el equipo quede horizontal, antes de ponerlo en marcha.

Atención

Al instalar el equipo de aire acondicionado en el techo se debe proteger la parte superior de la cabina con un paño ó manta protectora para evitar posibles arañazos. Al instalar **Compact** en el techo hay que tener en cuenta que, normalmente, las cabinas que vienen provistas de escotilla, tienen una estructura suficiente para soportar el peso del equipo. Sin embargo, cuando no ocurra así y sea necesario realizar corte en el techo o incluso si en el caso de llevar escotilla el material no es lo suficientemente resistente (caso de techo de fibra, plástico, etc...) es el instalador el que debe decidir, **bajo su responsabilidad**, sobre la necesidad de reforzar el techo para evitar posibles deformaciones, roturas, entradas de agua, etc... habilitando los medios para que esto no ocurra.

Herramientas

- Juego de Llaves Torx
- Juego de Llaves Allen
- Llave fija 10, 13, 14
- Tijeras
- Flexómetro







Documentación incluida

Instrucciones de montaje	1001207466
Manual del usuario	1001204545
Diagnóstico de averías	1001204543
Garantía	220AA10017

Simbología

-  Frágil
-  Atención corte!
-  Riesgo eléctrico

Advertencias

-  El personal instalador debe poseer una formación suficiente en Aire Acondicionado de vehículos.
-  **dirnaBergstrom, s.l.** queda exenta de responsabilidad si se producen averías que procedan de una inadecuada manipulación ó instalación del equipo, o por modificaciones y sustituciones efectuadas sin nuestra expresa autorización por escrito.
-  **Equipo precargado con gas** refrigerante R-134a. **(No manipular el circuito de gas refrigerante).**
-  Véase **procedimiento de garantía** del producto incluido en **Diagnóstico de Averías**.
-  Véase **Manual de Usuario** del equipo para el correcto funcionamiento del mando a distancia y del panel de control.
-  Al finalizar la instalación se debe entregar al usuario: **Manual del Usuario, Garantía y Diagnóstico de averías.**

 Antes de empezar con el montaje, montar rejilla entrada aire delantera.



1 Desmontar tapa escotilla, los elementos de fijación y entregar éstos al cliente (*).

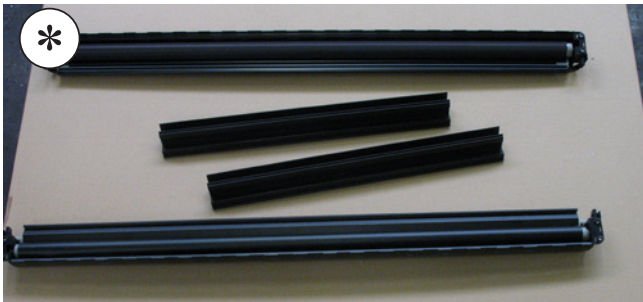

2 Quitar los residuos sobrantes adheridas al techo antes de pegar la junta EPDM.

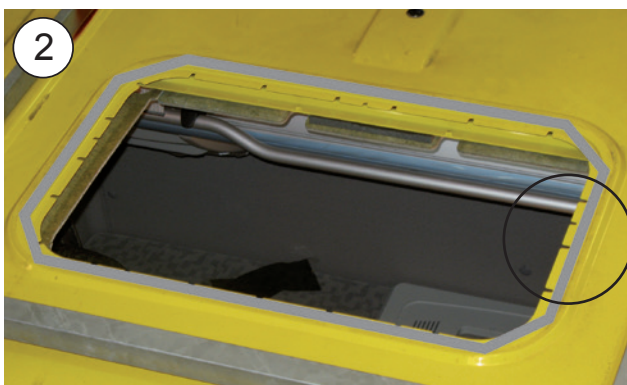

3

Pegue la junta EPDM alrededor del hueco de escotilla (*mirar el detalle para cortar los bordes finales de unión de la junta*).

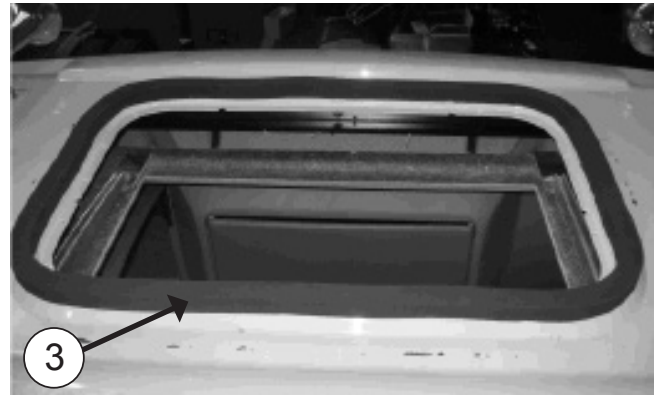

COMO CORTAR LA JUNTA EPDM PARA EVITAR FILTRACIÓN DE AGUA EN LA CABINA

- A- Pegar la junta, manteniendo 100 mm de papel protector por cada lado.
- B- Quita los dos piezas de papel.
- C- Pegue presionado ambos finales.

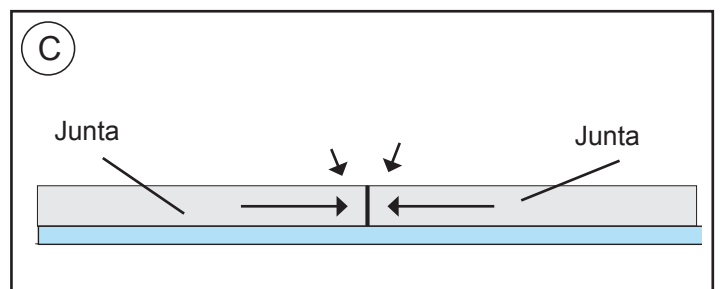
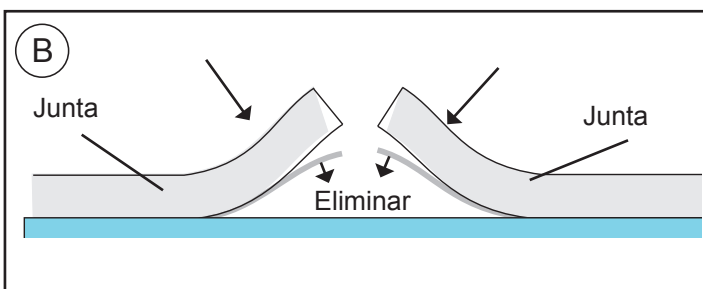
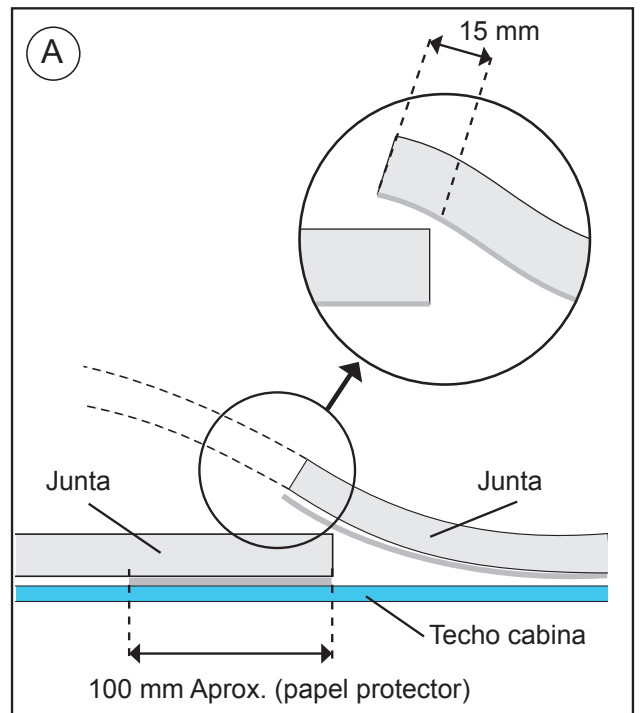

4 **EXTERIOR CABINA:**
 Posicionar el **Compact** en el hueco de la escotilla.

¡Atención! Al colocar el equipo encima del hueco escotilla, revisar que los tubos de desagüe no queden obstruidos por la junta EPDM.

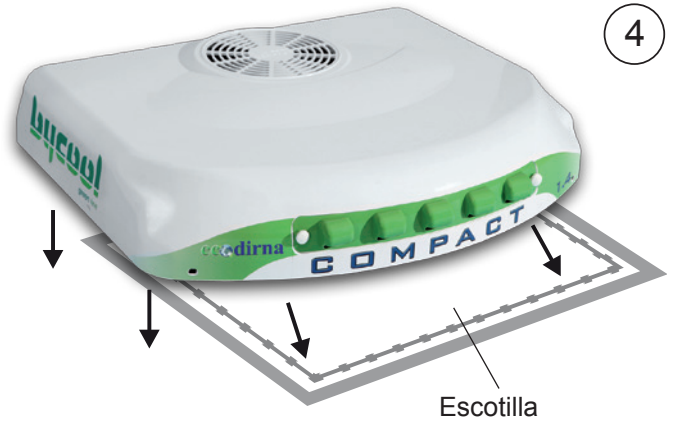

5 Colocar canalizador gomaespuma quedando la parte más blanda en la base del equipo.

Atención: Dependiendo de la cabina, es posible que sea necesario usar los (2) canalizadores suministrados para que el panel de distribución de aire quede totalmente ajustado con ellos.

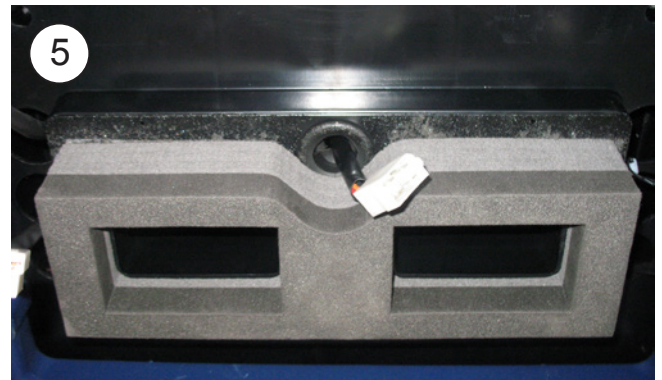

6 **INTERIOR CABINA:**
 Roscar 5 mm aproximadamente (4) espárragos 8/125x100-70 o 120, la medida se elegirá tras presentar los soportes de sujeción y teniendo en cuenta que los espárragos deben sobresalir de los mismos por la parte inferior unos 20 mm.

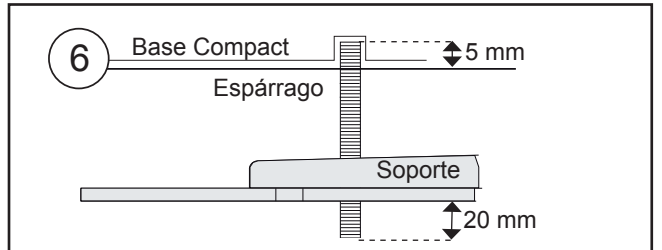

7 Colocar (1) arandela Ø 7 de goma, (1) arandela plana Ø 8 ala ancha, (2) tuerca M8 y (1) arandela plana Ø 8 ala ancha, en cada uno de los espárragos anteriores; siguiendo dicho orden.

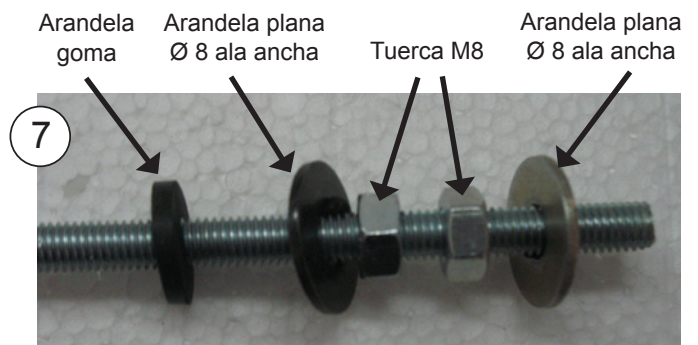

8 Colocar (2) soportes sujeción, con (1) arandela y (1) tuerca autoblocante M8, **sin llegar a apretar**.

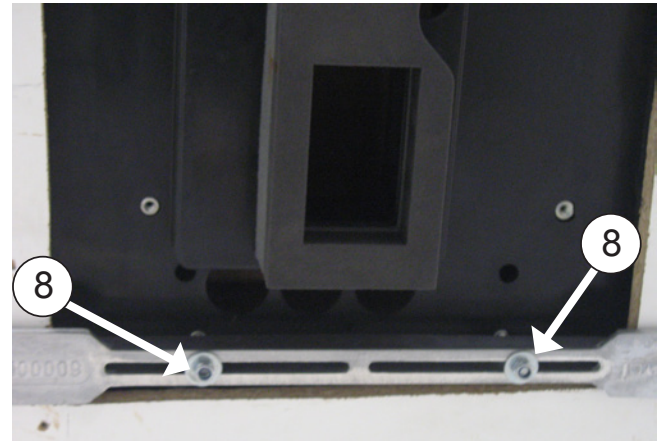
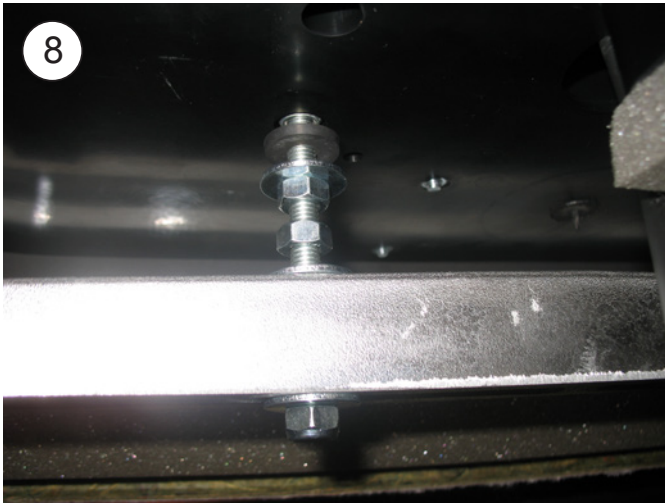

9 Roscar 10 mm (4) espárragos M6 x 80, donde se indica, según distancia (D) del esquema del punto 16.

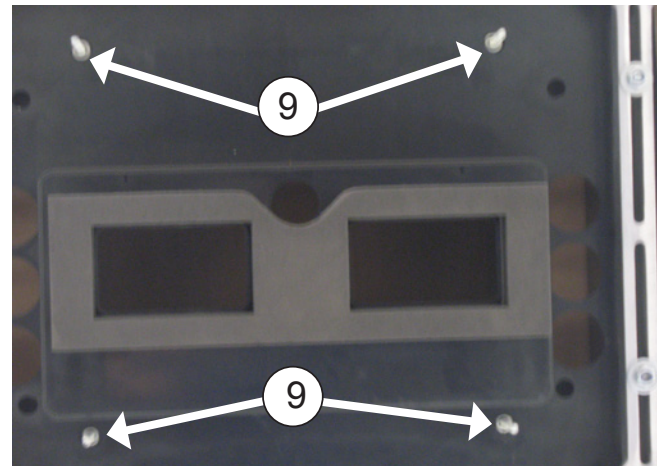
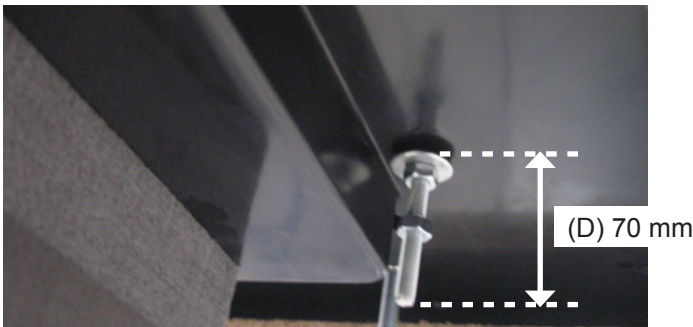

10 Colocar (1) arandela Ø6 de goma, (1) arandela plana Ø6 ala ancha y (1) tuerca M6, sobre cada uno de los espárragos de M6. **Apretar tuerca**, a continuación apretar tuerca hasta que la arandela de ogma quede un poco oprimida.

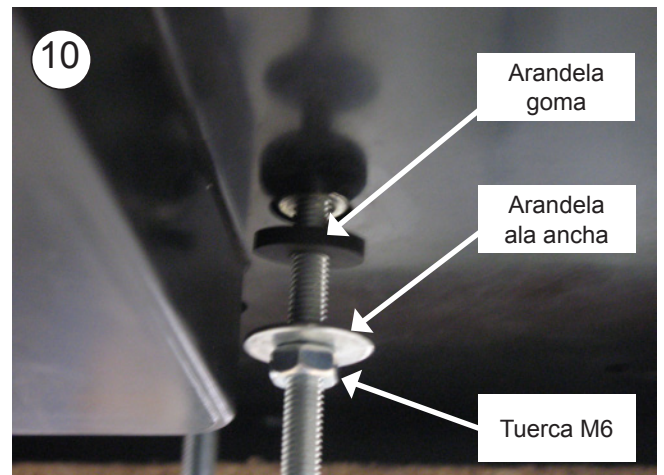

10a

Colocar (1) tuerca M6 **sin apretar** en cada espárrago.

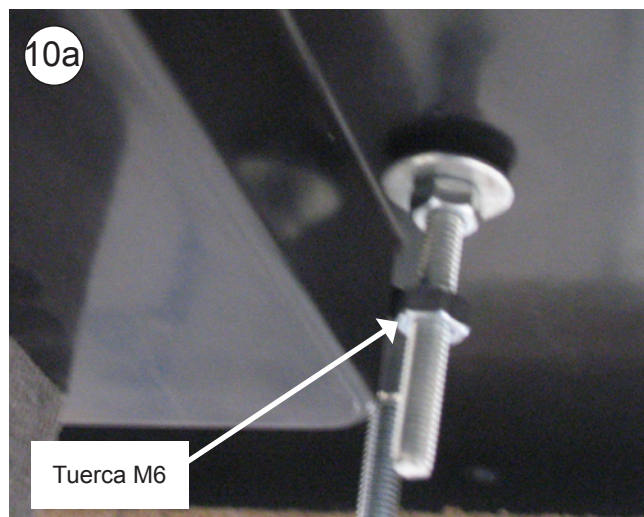
**10b**

Conectar la caja de 2 vías del sensor del aire de retorno, la caja de 4 vías del soplador y la de 8 vías de conexión de los cableados del control electrónico.

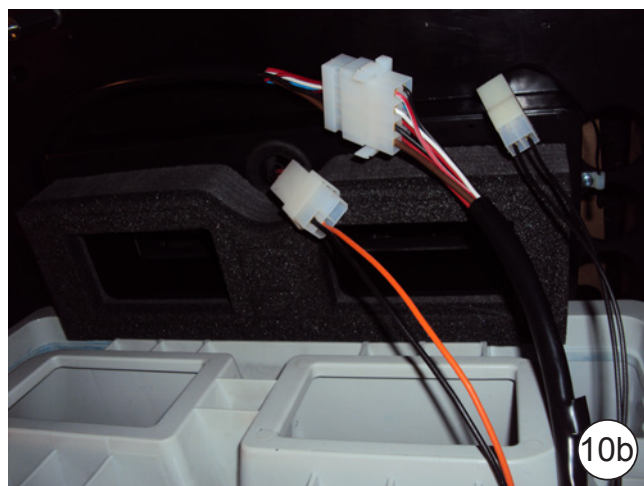

11

Colocar el panel interior de distribución de aire en los espárragos anteriores con (1) arandela M6 ala ancha y (1) tuerca M6 en cada espárrago. Apretar tuercas hasta que el canalizador del panel interior de distribución de aire haga tope en goma espuma superior del equipo.

Importante: El canalizador del panel interior de distribución de aire debe hacer tope contra la goma espuma superior del equipo para evitar fugas de aire.

Tener la precaución de no pillar los cableados entre el canalizador y la gomaespuma colocada en la base del equipo.

11

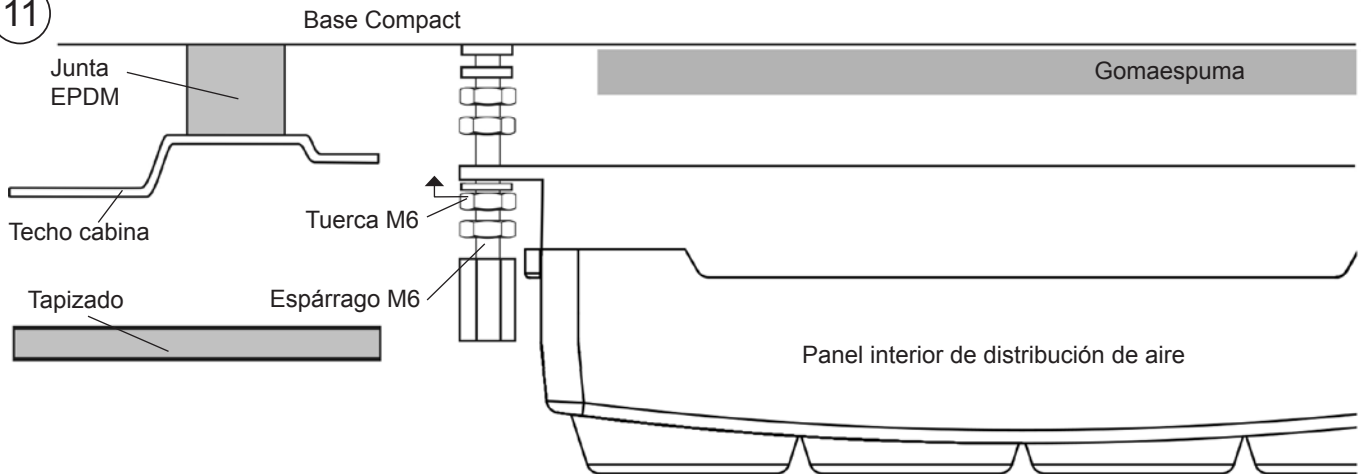

12

Apretar tuerca del punto 10a hasta hacer tope con la parte superior del panel interior de distribución de aire.

12

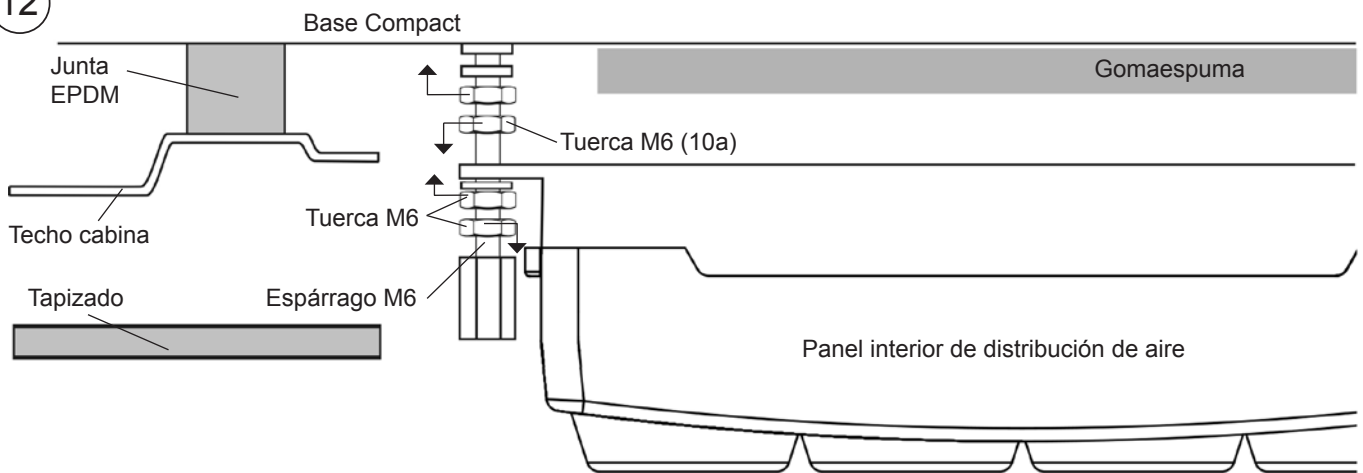

13 Presentar consola y centrar el equipo en el sitio más conveniente del techo de la cabina. Una vez centrado quitar consola.

14 Fijar los soportes de sujeción apretando las tuercas hasta el apriete de la junta de EPDM exterior del equipo entre 3 y 6mm.
Importante: Para evitar posibles filtraciones de agua al interior de la cabina se debe asegurar el apriete de la junta EPDM con la base del Compact tal y como se indica en el esquema.

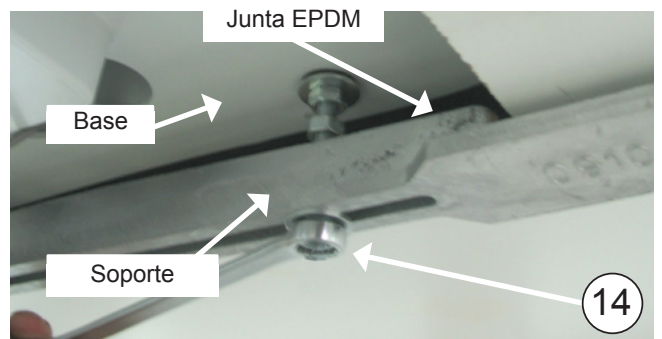
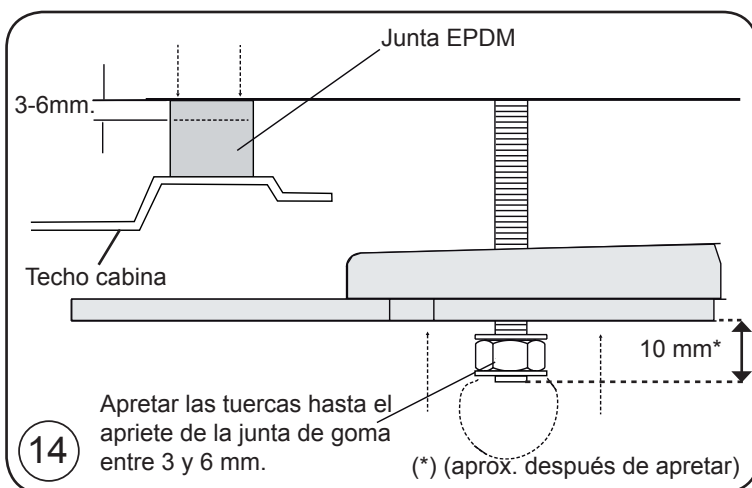

15 Apretar (4) tuercas M8 al soporte y (4) a la base del Compact.

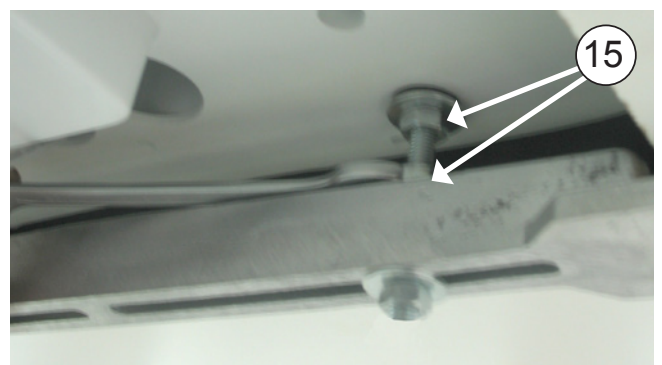

16

Colocar tuerca M6 (A) tras la tuerca de fijación del panel interior de distribución de aire en cada espárrago. Colocar exágonos M6 roscandolo hasta que quede 1 mm por encima del tapizado. Desenroscar tuercas M6 (A) de este punto hasta que haga tope con los hexágonos y apretar contra estos.

16

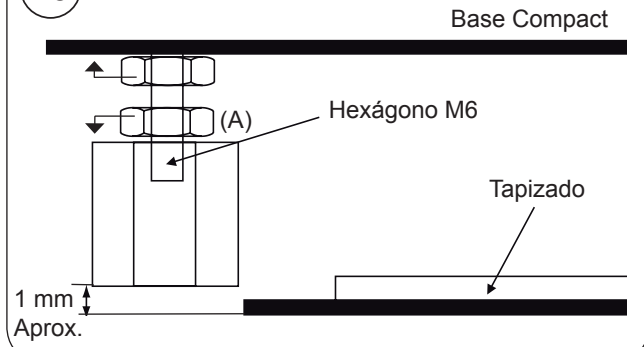

16

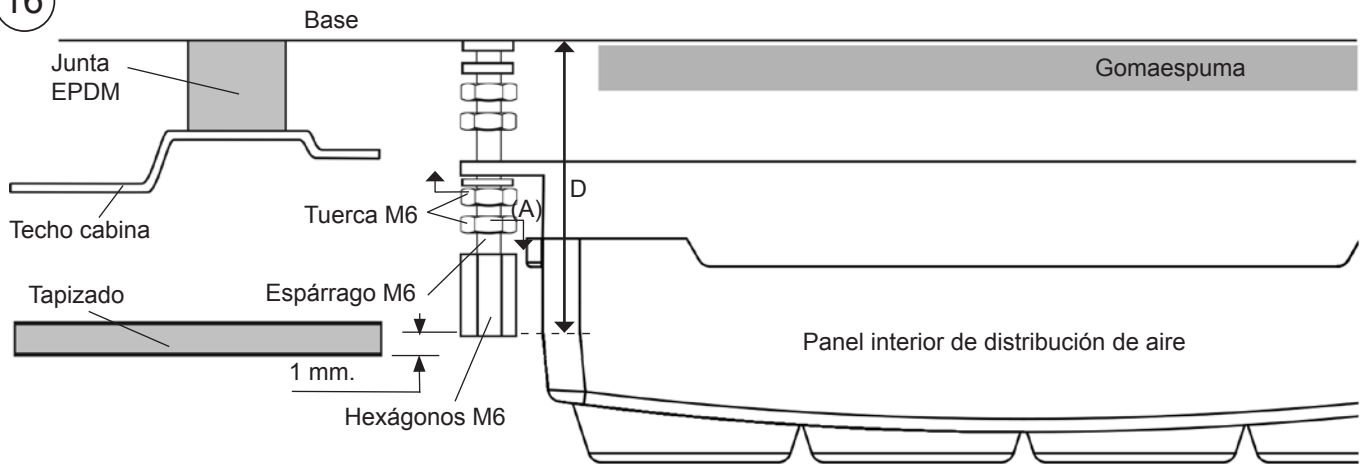

17

Colocar la consola con (4) tornillos M6/100x15 allen.



18 Cubrir los (4) tornillos M6/100x15 allen con los embellecedores redondos de M6 de plástico.



Vista explosionada hasta la fijación de los soportes

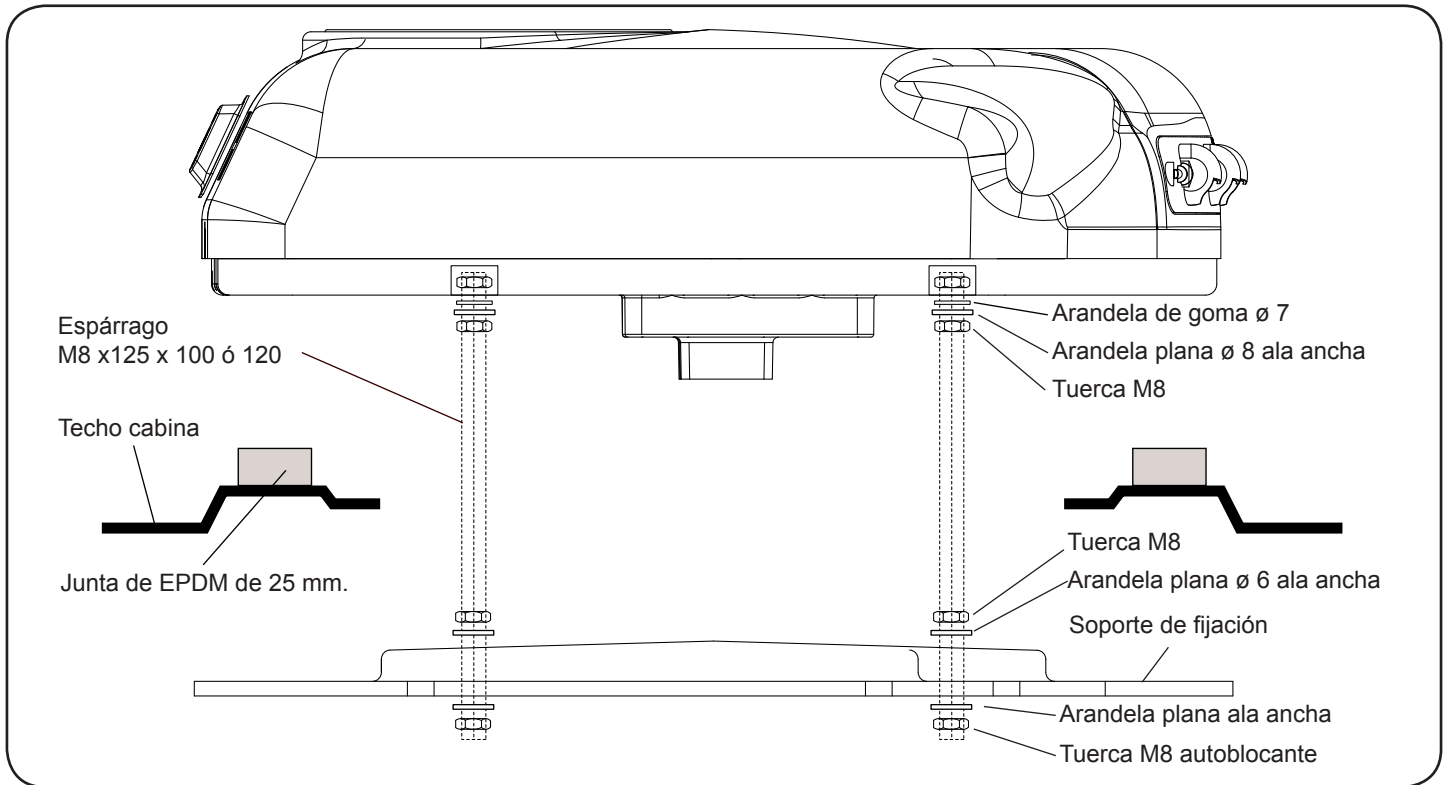

Vista explosionada hasta la fijación de las consolas

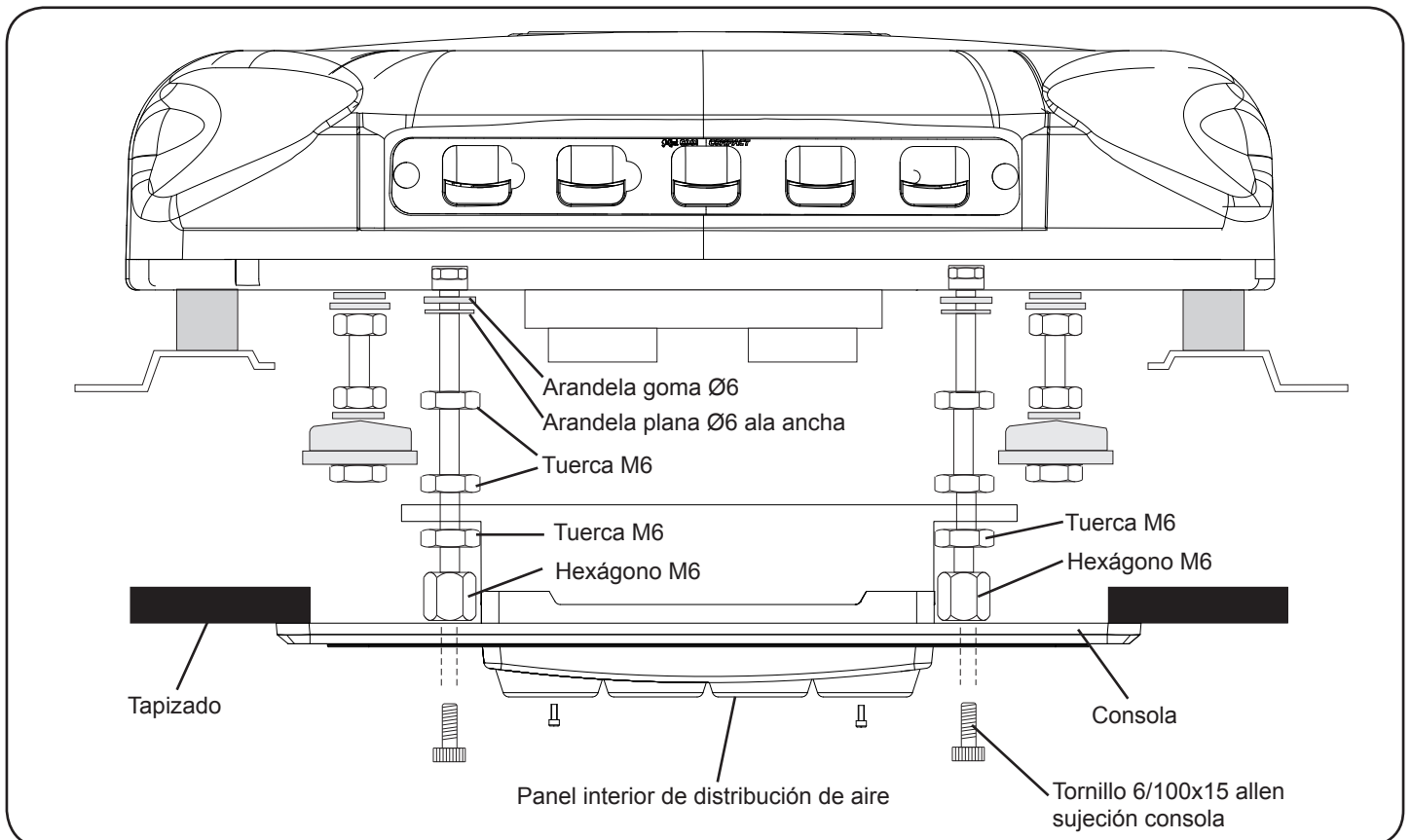

Instrucciones detalladas
sobre la instalación del cableado de alimentación



Cableado de alimentación

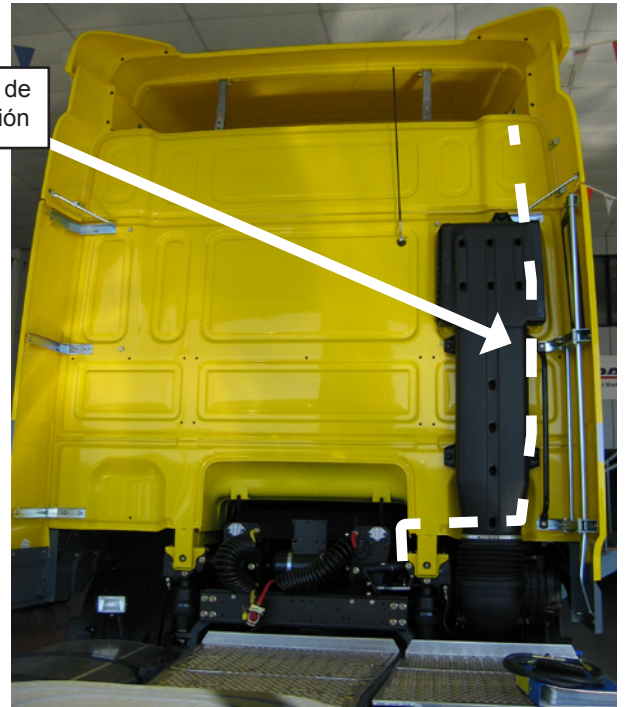

1- Llevar el cable de alimentación del equipo hasta la batería del vehículo, pegando los soportes de plástico en la parte posterior de la cabina y fijándolo con bridas; después con la cabina abatida pasar el cable por la parte inferior de la misma sujetándolo con abrazaderas y tornillos M4; y hasta la batería con bridas; se debe utilizar el mismo paso del cableado original. *(Para pegar los soportes de plástico limpiar bien la zona antes)*. Al conectar el equipo a la batería éste hará un test en todos sus leds, aparecerá en el display 88--bd y se apagará.

IMPORTANTE: Debido al complejo sistema de regulación electrónica del equipo, la toma de corriente debe realizarse directamente a la batería del vehículo, no a cualquier otro punto que dé servicio a otros accesorios del vehículo teniendo la precaución de no invertir la polaridad al realizar la conexión (2). Si se invierte la polaridad la placa de mandos se enciende y el equipo no funciona.

IMPORTANTE: Para la puesta en marcha consultar el Manual del Usuario.



Esquema eléctrico

¡AVISO IMPORTANTE!

Precaución de no invertir las polaridades al conectar el equipo a la batería. Si esto sucediera, la placa de mandos no se enciende y el equipo no funciona.

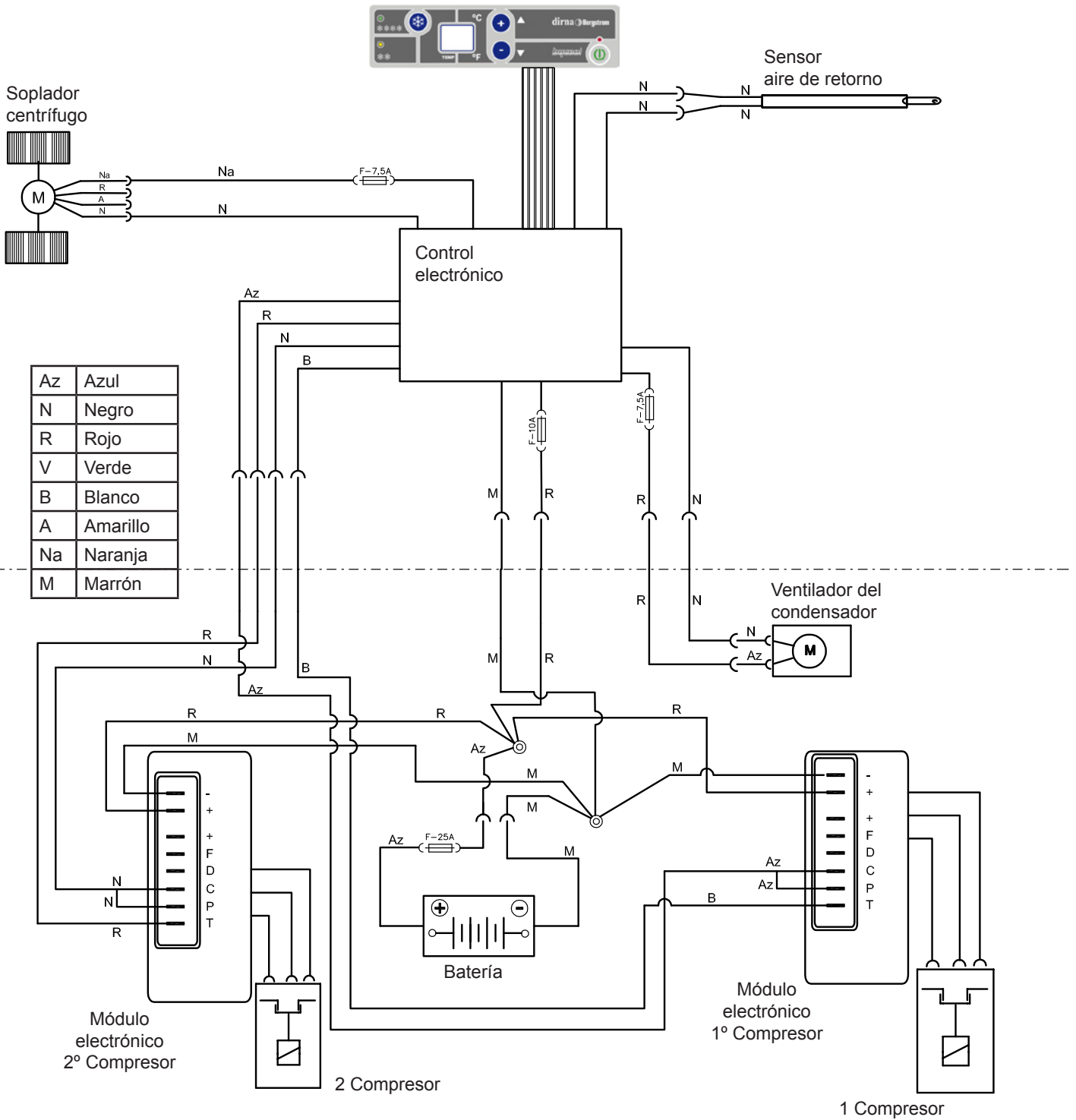

Assembly Recommendations

- Before starting assembly, please read instructions and follow them during installation process.
- Use the adequate tools for each operation.

Electricity

- Disconnect ignition key.
- Disconnect battery before starting assembly.
- Make sure electric components are securely connected, checking their correct fitting.

Warning

If the unit slants during assembly, wait for at least 60 minutes with the unit in horizontal position before starting it up.

Warning

When installing air conditioning equipment on roof, the upper cabin part must be protected with a cloth or a protective blanket to avoid possible scratches. When installing **Compact** on roof, take into account that, normally, cabins equipped with a hatch have a strong enough structure to hold equipment weight. However, if it is not the case and it is necessary to carry out a cut in the roof or, although it has a hatch, the material is not resistant enough (*if roof is made of fibre, plastic, etc...*), it is the installer who will have to decide, under his responsibility, if it is necessary to reinforce the roof to avoid possible deformations, breaks, water entries, etc., habilitating the means required to stop it from occurring.

Tools

Torx wrenches set
 Allen wrenches set
 Open-jawed spanner 10, 13, 14
 Scissors
 Flexo-meter

Documentation included

Mounting instructions	1001207466
User's guide	1001204545
Troubleshooting	1001204543
Warranty	220AA10017

Symbology



Fragile









Beware of cuts!



Electrical hazard

Warnings

-  The installing personnel must have a sufficient training in vehicles air conditioning.
-  **dirna Bergstrom, s.l.** shall not be responsible for breakdowns or damages coming from an inadequate handling or installation of the equipment or from modifications and substitutions carried out without our express and written authorisation.
-  **Equipment pre-charged with refrigerating gas, R-134a. (Do not handle refrigerating gas circuit).**
-  Please see product **warranty procedure** included in **Troubleshooting**.
-  Please see equipment **User's Guide** for its correct functioning of the remote control and control panel.
-  Once installation is finished, the following documents must be handed over to the user: **User's Guide, Warranty and Troubleshooting**.

 Mount the front air input grille before starting assembly.



1 Dismantle sun hatch, fastening elements and hand over to client (*).

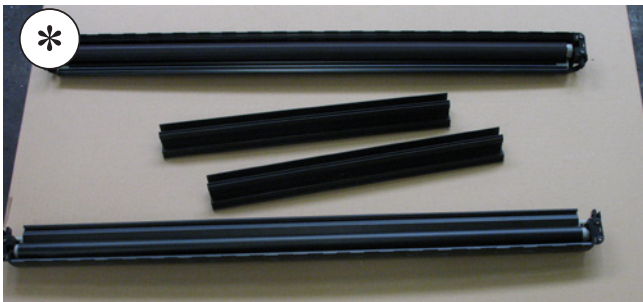

2 Remove residual glue substance of the roof upper surface before glueing EPDM gasket.

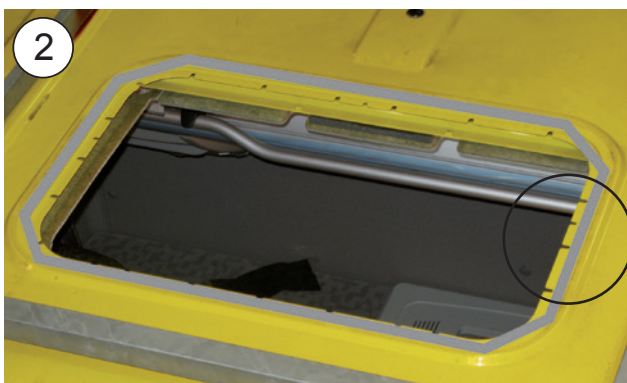

3 Glue EPDM gasket around hatch hole (see detail for cutting end join edges).

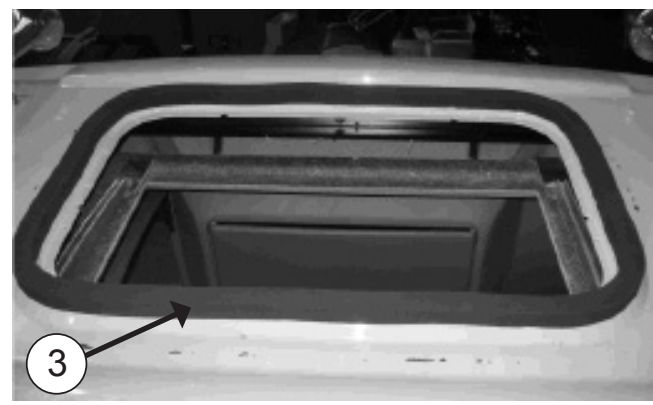

 **HOW TO CUT EPDM GASKET TO AVOID WATER FILTRATION INTO THE CABIN**

A- Glue gasket, keeping 100 mm of protection paper at each side.

B- Remove the two pieces of paper.

C- Glue by pressing both ends.

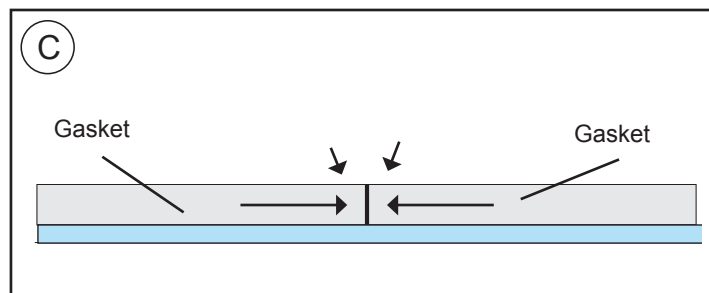
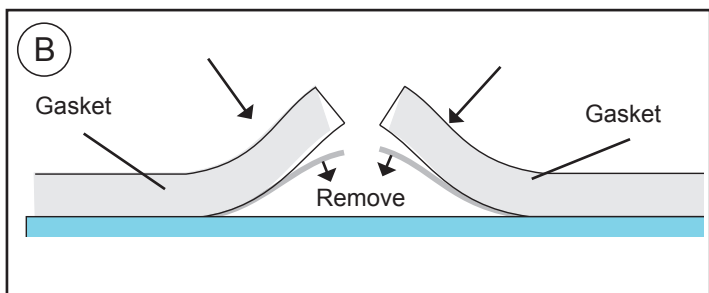
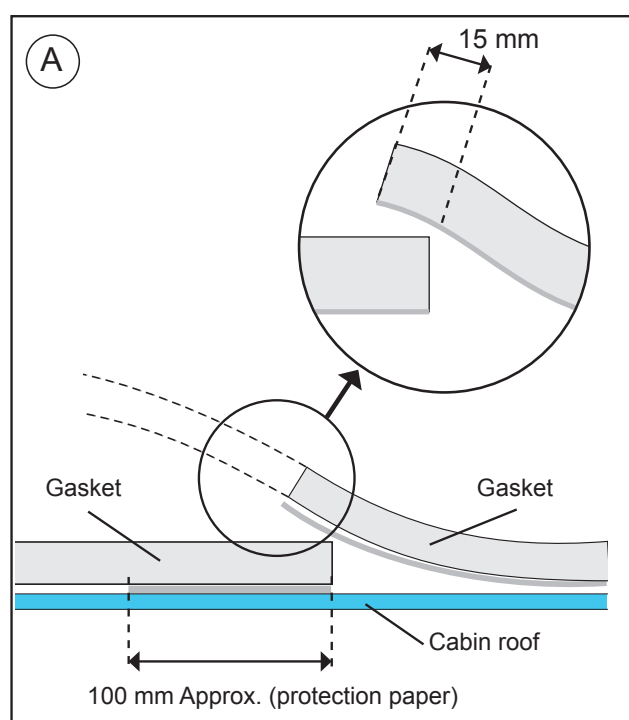

4 **OUTSIDE CABIN:**
Position **Compact** in sun hatch hole.

Caution! When positioning the unit above the hatch gap, check that the wastewater run-offs are not blocked by the EPDM seal.

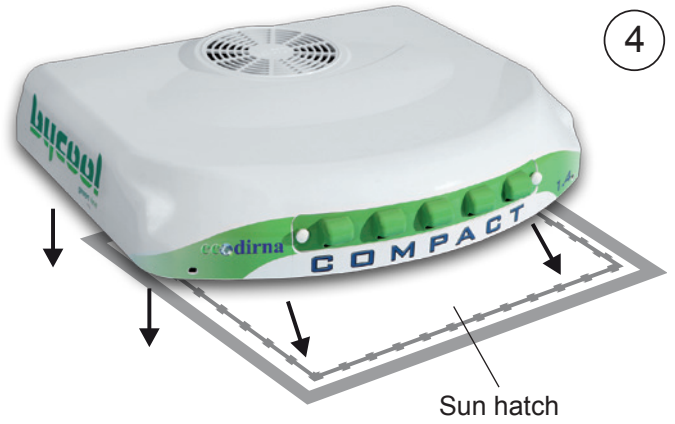

5 Position the foam rubber, ensuring the softest part is placed on the base of the unit.

Caution: Depending on the cabin, it may be necessary to use the (2) supplied ducts in order for the distribution panel to be completely adjusted.

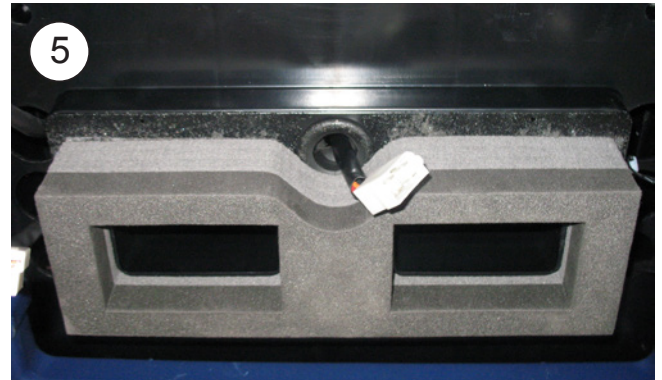

6 **INSIDE CABIN:**
Screw about 5 mm (4) 8/125x100 or 120 mm studs, the exact measure is chosen after the fastening supports have been presented and taking into account that studs must stick out of lower part about 20 mm.

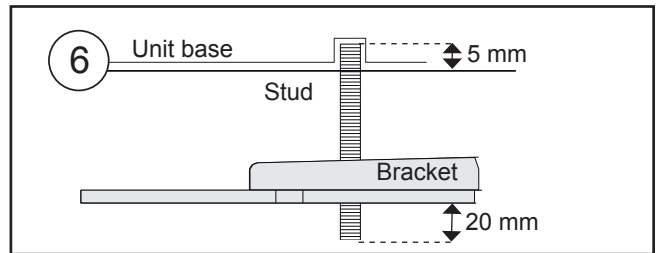

7 Following this order:
- Ø 7 plane rubber wash
- plane rubber wash wide wing diameter 8
- nut M8
- plane washer diameter 8 wide wing

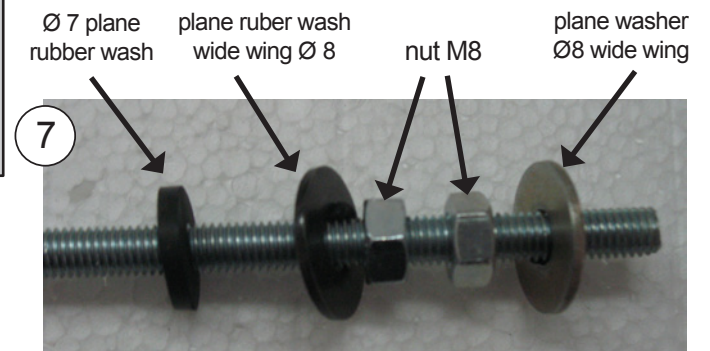

8 Place (2) fastening supports, with (1) washer and (1) M8 self-blocking nut, **without tightening.**

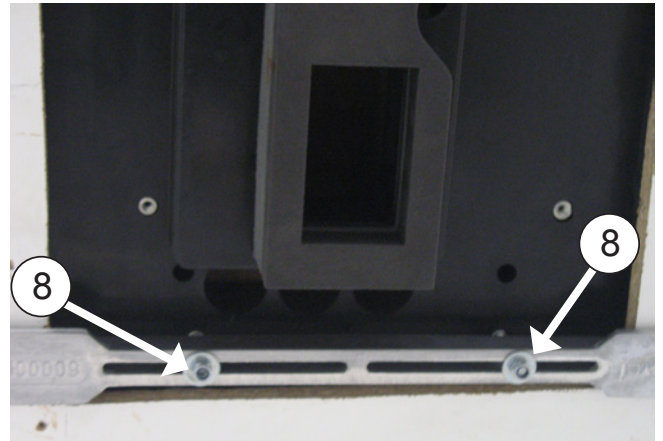
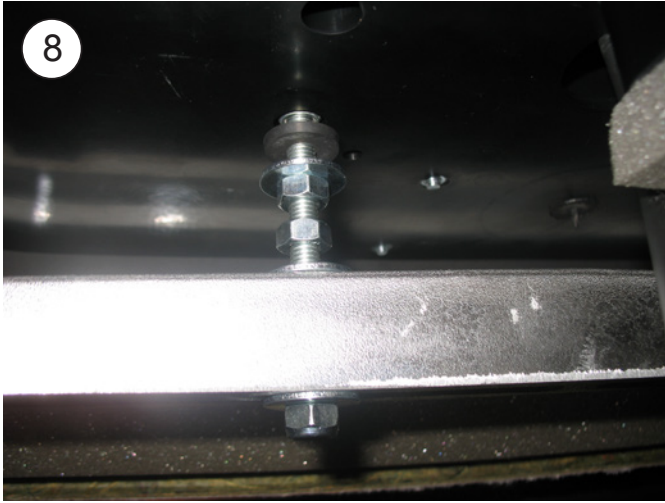

9 Screw 10 mm deep (4) M6 x 80 studs, where indicated distance (D) in figure point 16.

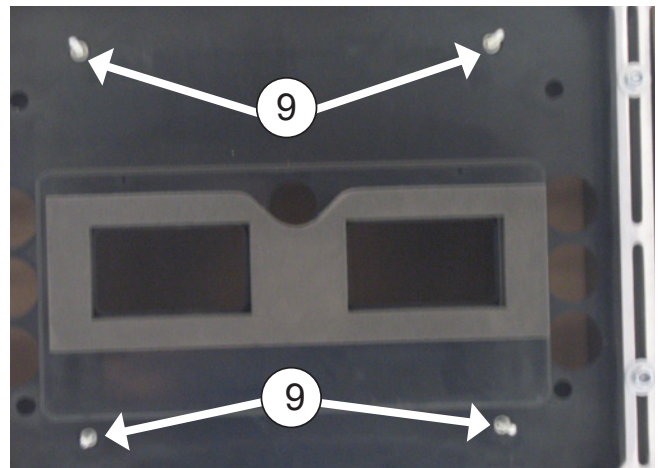
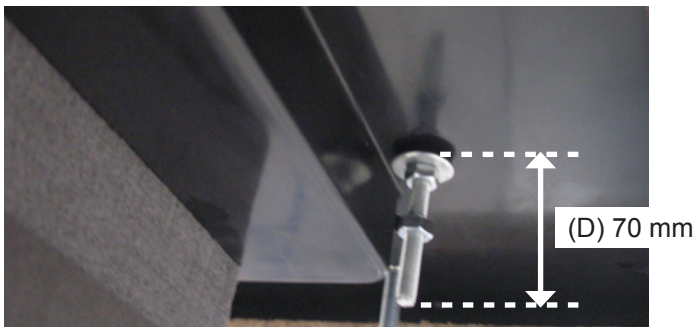

10 To place (1) rubber washer diameter 6 (1), plane washer diameter 6 wide wing and (1) nut M6, over each of the spigots of M6. After, to tight the nut til the rubber washer remain a little tight.

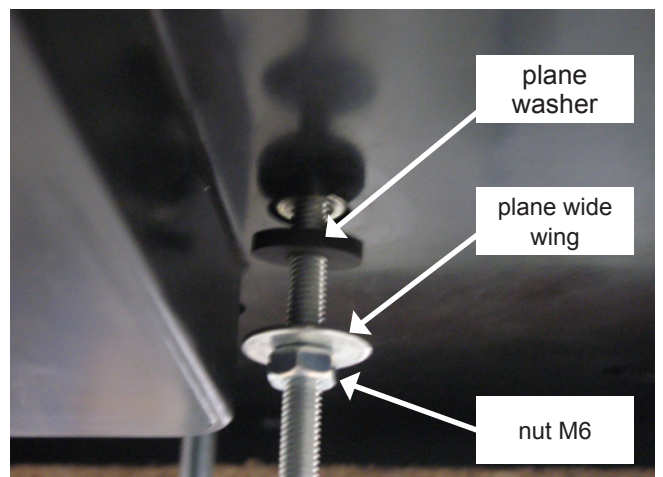

10a Place (1) nut M6 without tight in each stud.

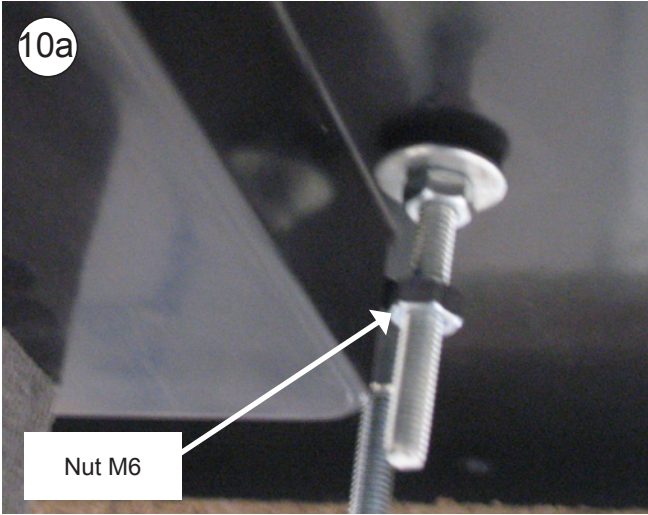

10b Connect the return air sensor 2-way box, the blower 4-way box and the electronic control cable connection 8-way box.

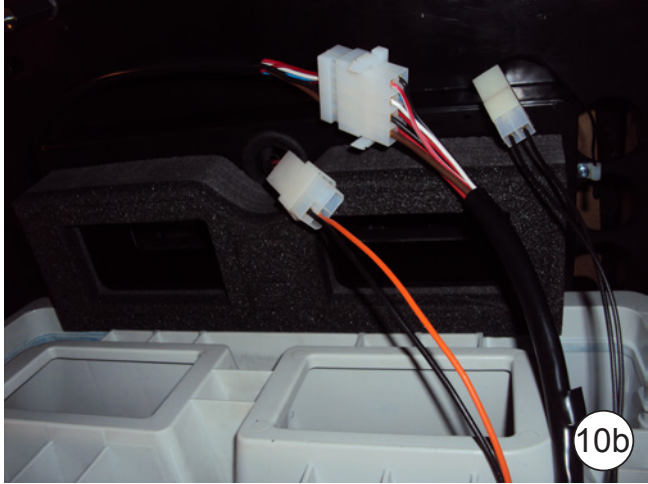

11

Position the interior air distribution panel on the front studs with (1) M6 wide-flanged washer and (1) M6 nut on each stud. Tighten the nuts until the interior air distribution panel duct comes up against the unit's top foam.

Important: The interior air distribution panel duct must come up against the unit's upper foam in order to prevent any leakages of air.

Take care to ensure the cables do not become trapped between the duct and the foam in the base of the unit.

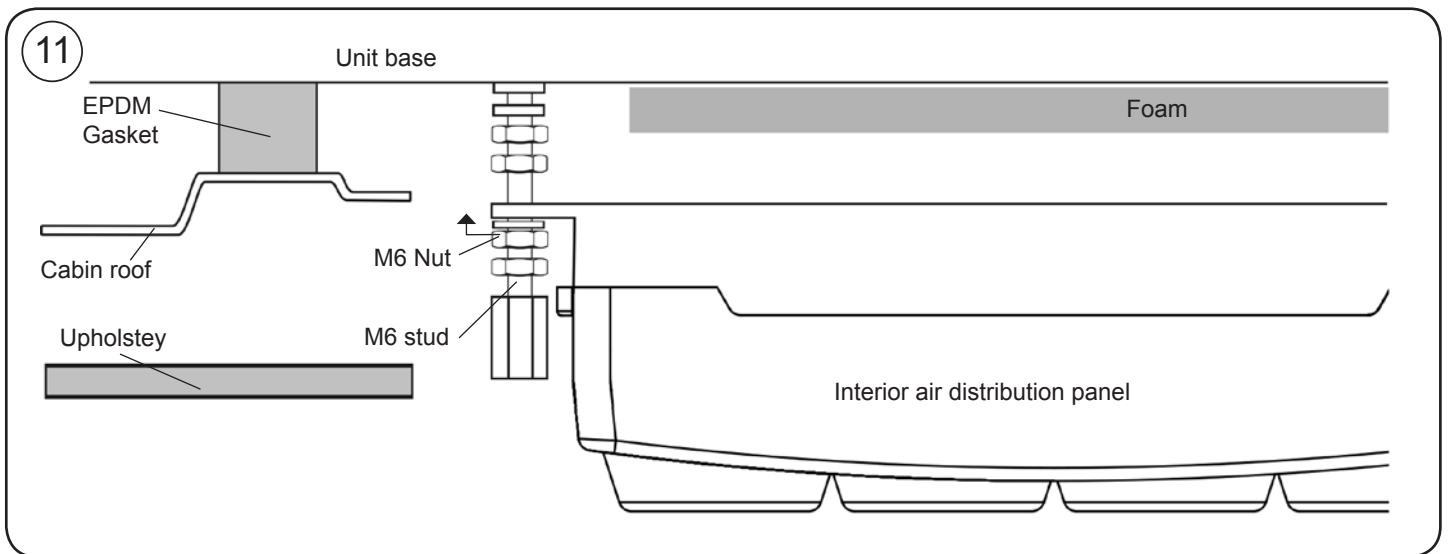

12

Tighten the nut in point 10a until it comes up against the top part of the interior air distribution panel.

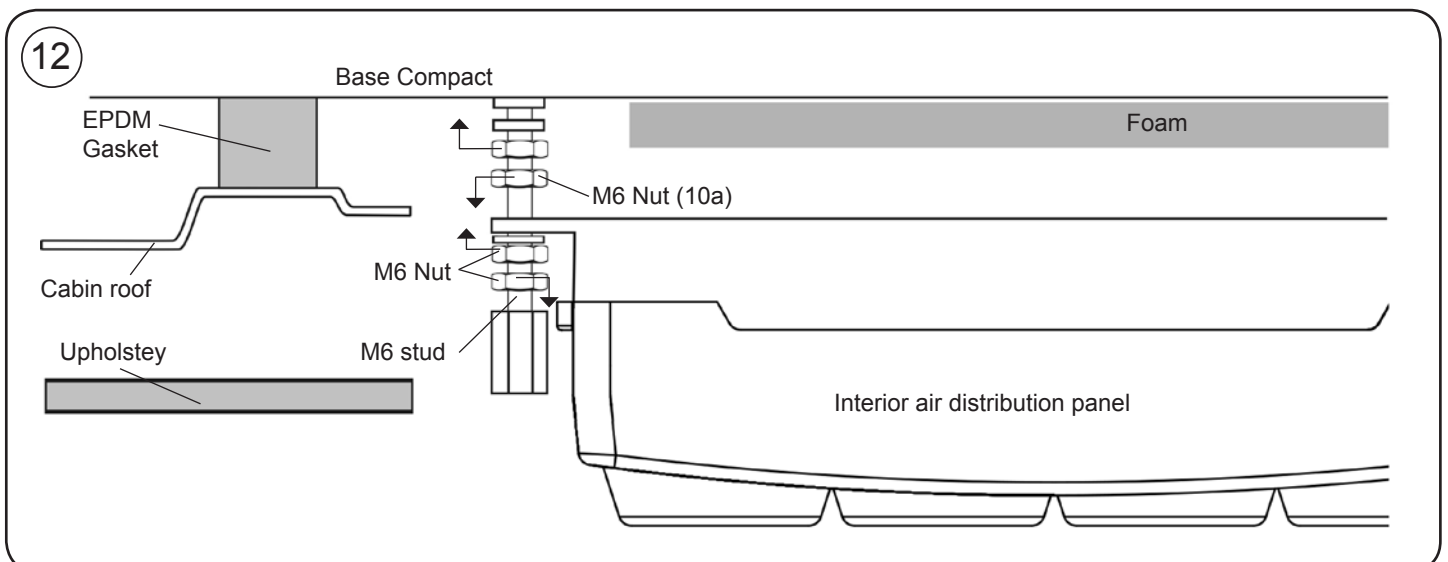

13 Place console and centre equipment in the most convenient place of cabin roof. Once centred, remove console for later installation.

14 Fasten supports tightening nuts until outside EPDM joint of equipment is compressed, between 3 and 6 mm;

Important: To avoid water from filtering inside cabin, check EPDM joint tightening with Compact base, as indicated on **diagram**.

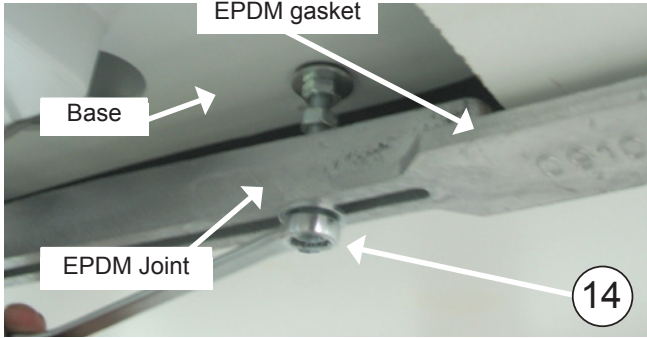
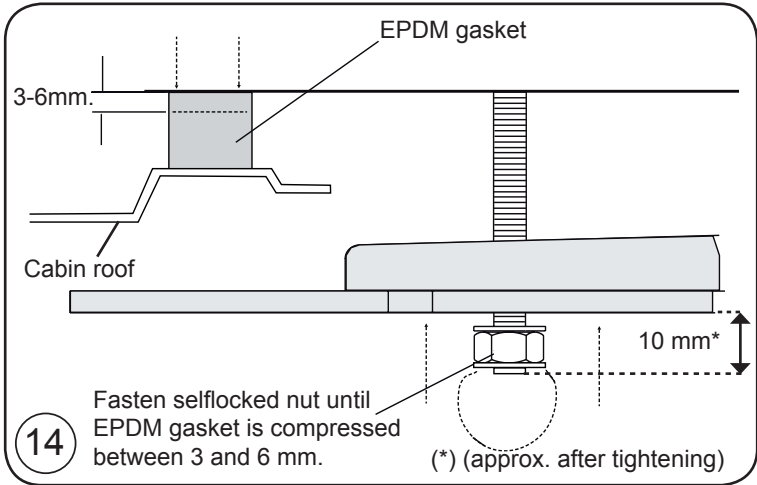
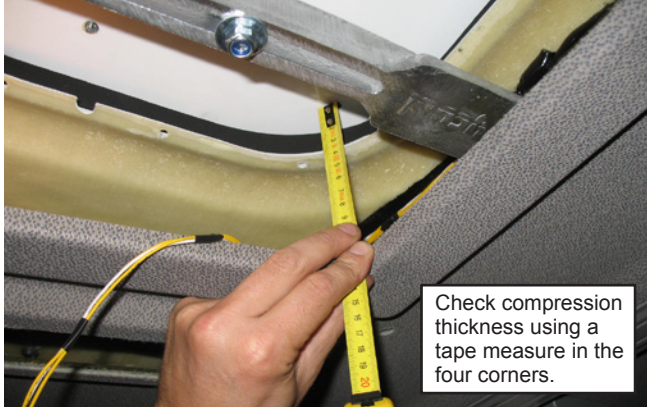

15 Tighten (4) M8 nuts to support and (4) to Unit base.

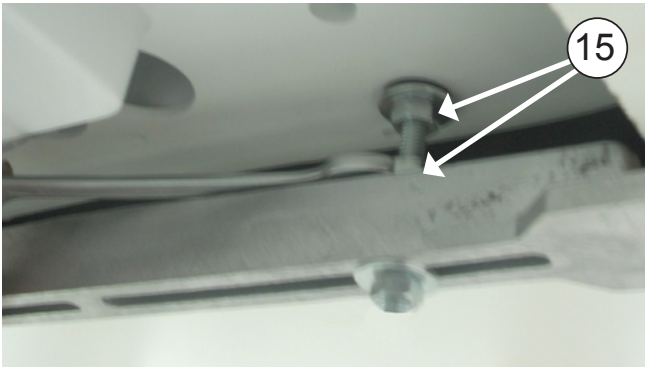

16

Position nut M6 (A) after the fastening nut of the interior air distribution panel on each stud. Screw on M6 hexagons up to 1 mm above the upholstery. Unscrew M6 nuts (A) of this point until they come into contact with the hexagons, and tighten against them.

16

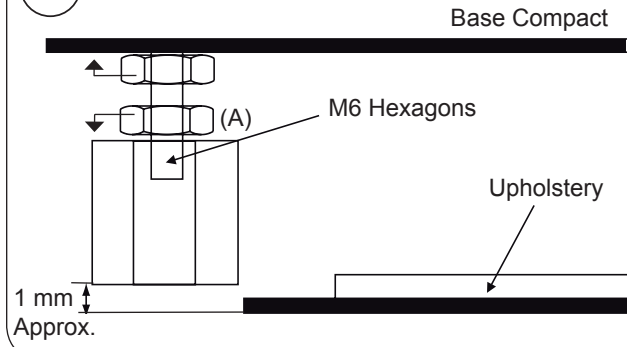

16

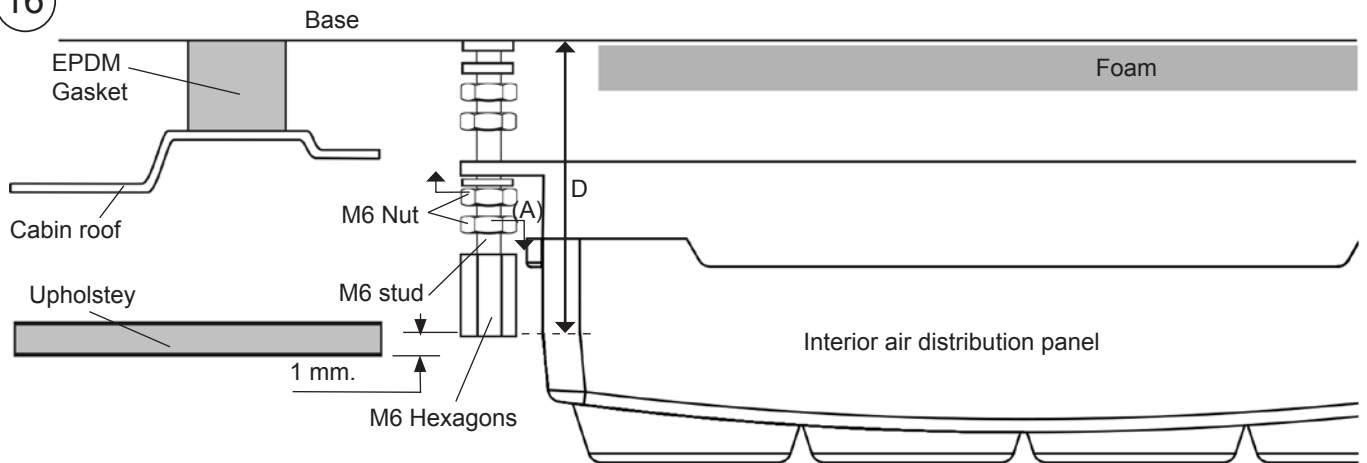

17

Place console using (4) M6/100x15 allen head screws bolts.

17



17



18 Cover the (4) nuts M6/100 x 15 allen with the round protection caps of M6 plastic.



Exploded side view to supports fastening

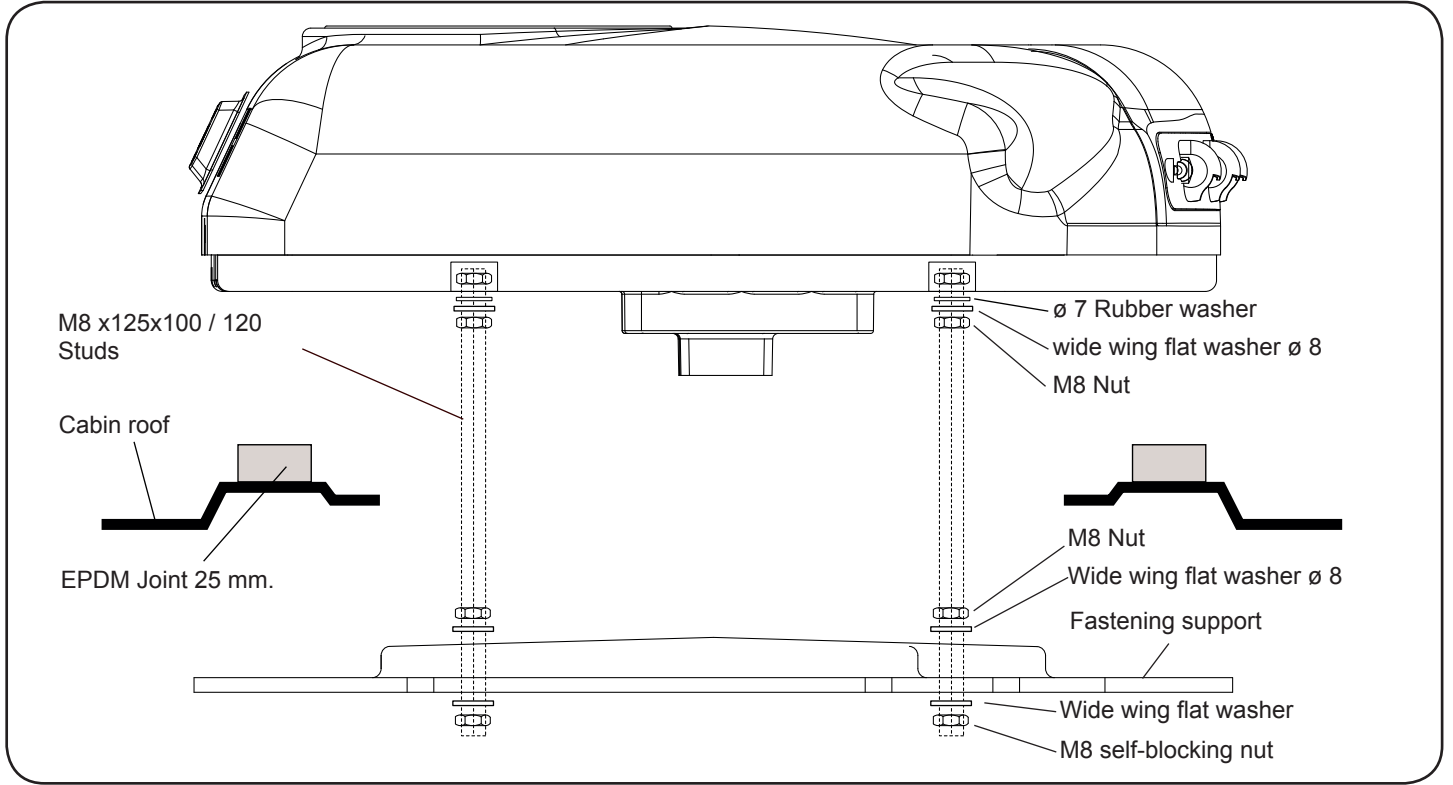

Exploded rear view to consoles fastening

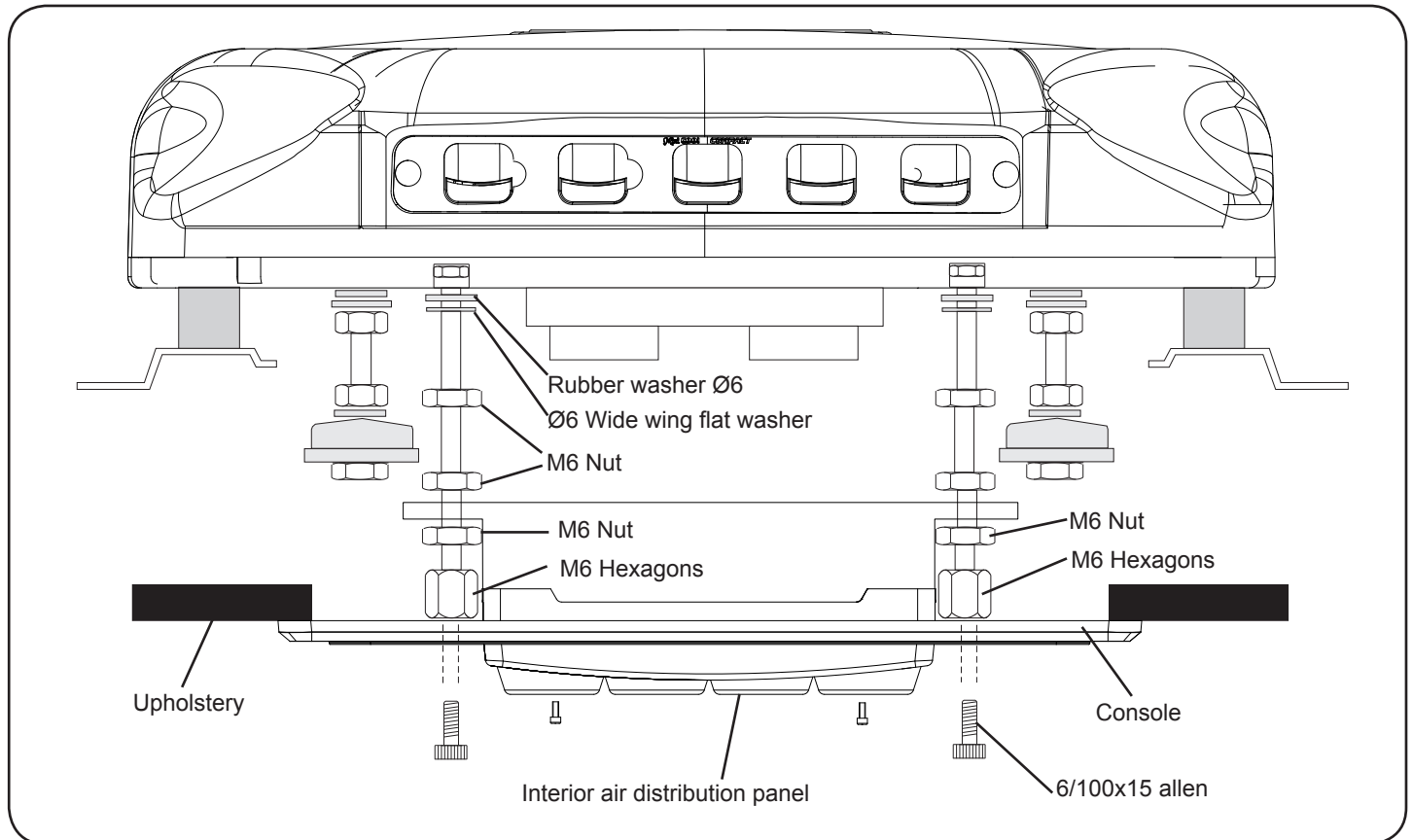

Detailed instructions on power wiring assembly

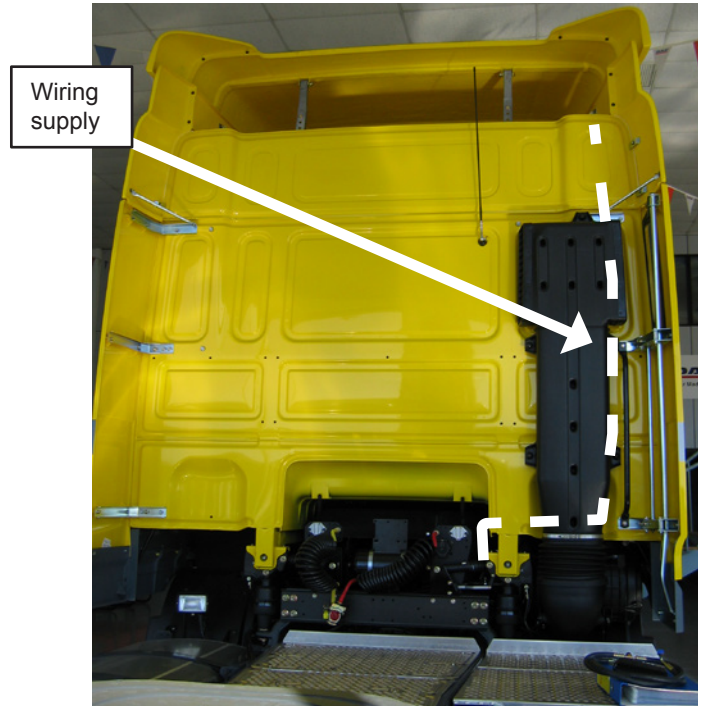

1-Lead equipment power cable up to the vehicle's battery, gluing plastic supports on rear cabin side and fastening it with flanges. Once cabin has been folded, lead cable along lower cabin side, fastening it with clamps and M4 screws and up to battery with flanges. It must follow the same passage as original cable (thoroughly clean the area before gluing plastic supports). When connecting equipment to battery, it will carry out a test of all its leds, 88--bd will show on the display and it will then be turned off.

IMPORTANT: Due to the complex electronic control system of the unit, the current supply connection must be made directly to the battery, not to any other existing point available to feed other vehicle accessory or appliance, taking care of not changing polarity (2). Should polarity be inverted, the plate does not come on and the unit does not work.

IMPORTANT: Please consult User's Guide before starting.

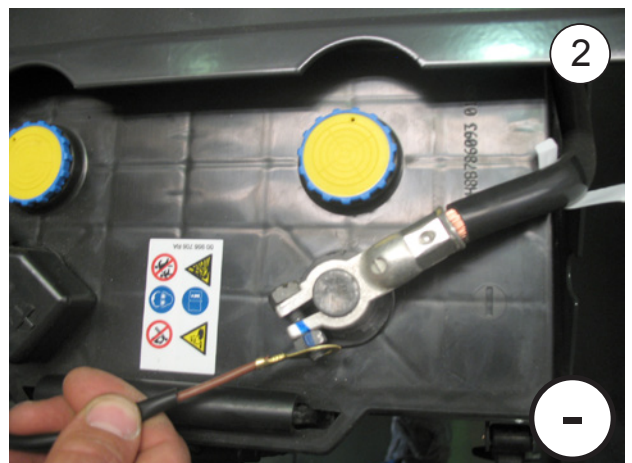

Electric wiring

IMPORTANT WARNING!

Take care not to invert the polarities when connecting the equipment to the battery. If this happens, the plate does not come on and the unit does not work.

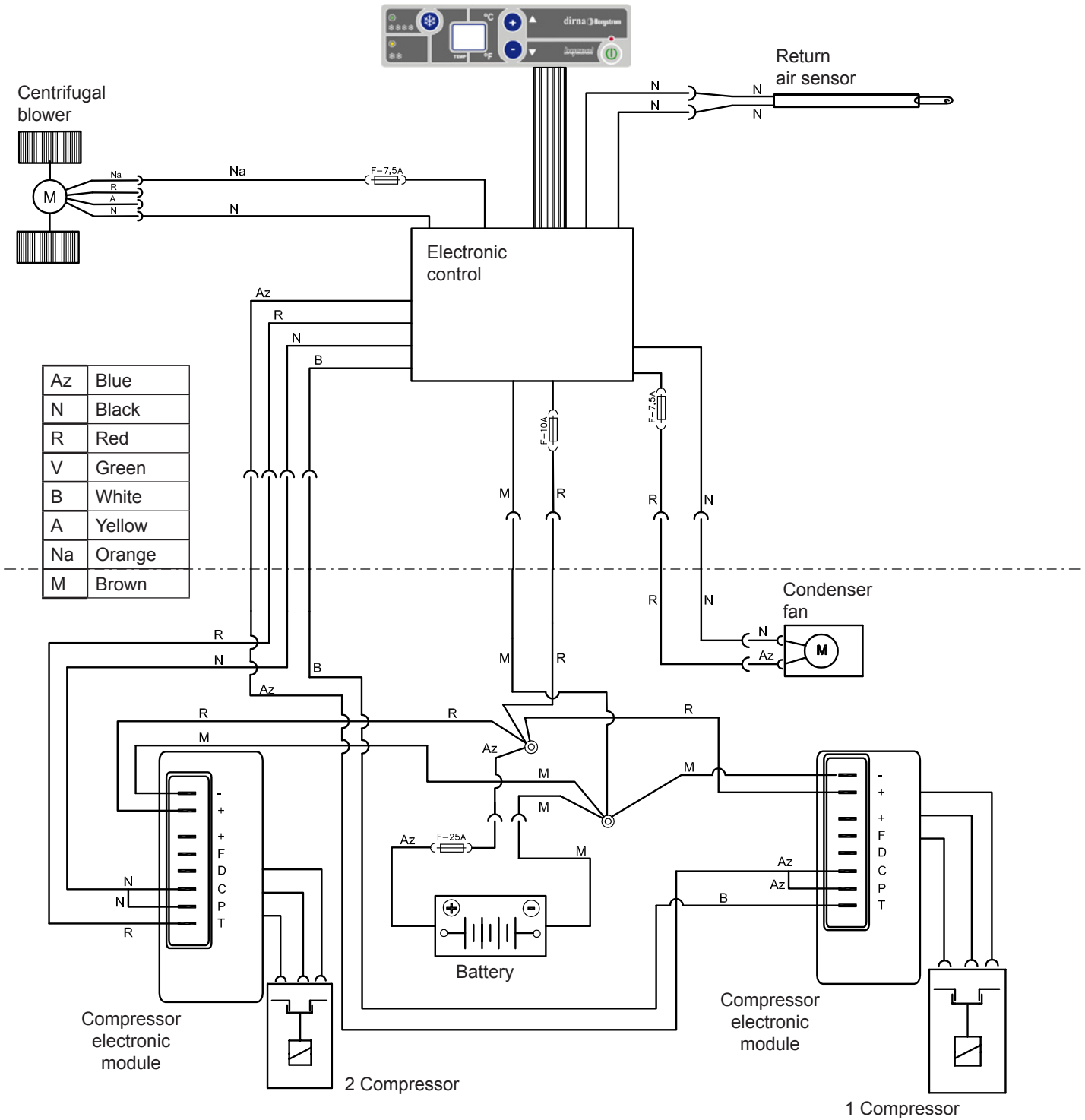

Recommandations Pour Le Montage

- Avant de commencer le montage de l'appareil, prière de lire les instructions et de les suivre attentivement.
- Utiliser les outils convenant à chaque opération.

Electricity

- Déconnecter la clé de contact.
- Déconnecter la batterie avant de commencer le montage.
- Vérifier le câblage des composants électriques et leur correcte installation.



Attention

Si pendant le montage l'équipement est incliné, il faudra attendre au moins 60 minutes avant de le mettre en marche une fois qu'il aura été remis sur sa position horizontale.



Attention

Lors de l'installation de l'appareil d'air conditionné sur le toit, il faudra protéger la partie supérieure de la cabine avec un linge ou une couverture de protection afin d'éviter les éventuelles égratignures.

Durant l'installation du **Compact**, tenir compte du fait que normalement les cabines pourvues d'écouille possède une structure suffisamment solide pour supporter le poids de l'appareil. Cependant, si ce n'est pas le cas et qu'il est nécessaire de découper le toit ou même si disposant d'écouille, la structure n'est pas suffisamment rigide (si elle était en fibre, plastique, etc.) il appartiendra à l'installateur de décider s'il faut renforcer le toit pour éviter toute déformation, rupture ou voie d'eau, etc., et prendre les mesures nécessaires à cet effet.

Outils

Jeu de clés Torx
 Jeu de clés Allen
 Clé fixe 10, 13, 14
 Ciseaux
 Mètre

Documentation included

Instructions de montage	1001207466
Guide de l'utilisateur	1001204545
Solution des problèmes	1001204543
Garantie	220AA10017

Symbologie



Fragile



Attention aux coupures !



Risque électrique

Garantie

⚠ L'installateur devra posséder la formation pertinente en air conditionné sur véhicules.

⚠ **dirna Bergstrom, s.l.**, ne sera pas responsable des dommages ou des bris dérivés d'une installation ou d'une manipulation incorrecte ni des modifications réalisées sans autorisation expresse par écrit.

⚠ **Appareil pré-chargé de gaz réfrigérant, R-134. (Ne pas manipuler le circuit de gaz réfrigérant).**

⚠ Voir la **procédure de garantie** du produit au **Diagnostic de problèmes**.

⚠ Voir le **Guide de l'Usager** de l'appareil pour le fonctionnement correcte de la télécommande et du tableau de commande.

⚠ Après l'installation, vous devez fournir à l'utilisateur: Manuel d'utilisation, garantie et diagnostic de pannes.

 Avant de commencer le montage, monter la grille d'entrée d'air frontale.



1 Démontez le couvercle de l'écouille, les éléments de fixations et les remettre au client (*).



2 Éliminer les restes d'adhésif de la surface supérieure de la cabine avant de coller le joint EPDM.

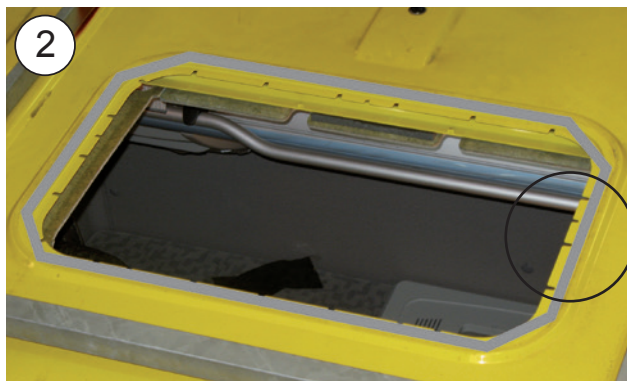

3 Coller le joint EPDM autour de l'orifice de l'écoutille (voir détail pour découper les bords).

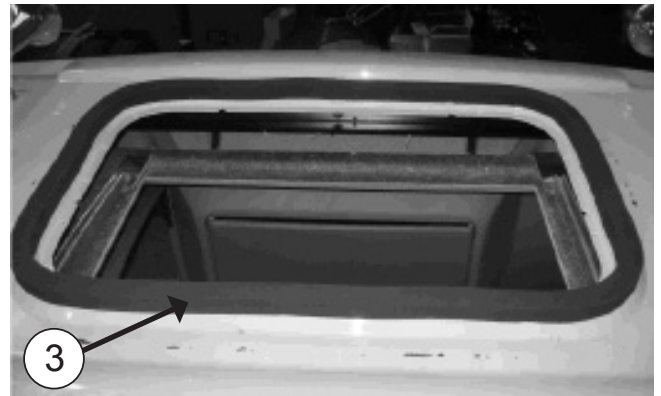

 **COMMENT COUPER LE JOINT EPDM POUR EVITER LES FILTRATIONS DANS LA CABINE**

A- Coller le joint en maintenant une protection en papier de 100 mm de chaque côté.

B- Retirer les deux morceaux de papier.

C- Coller en faisant pression sur les deux extrémités.

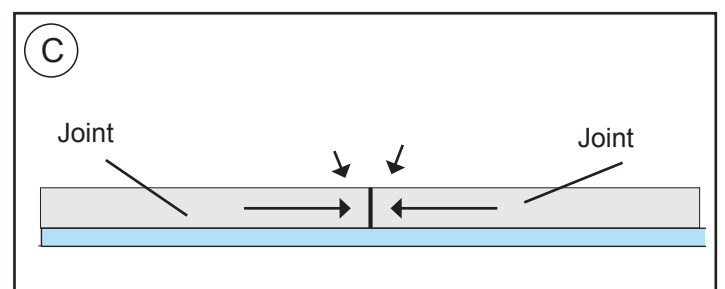
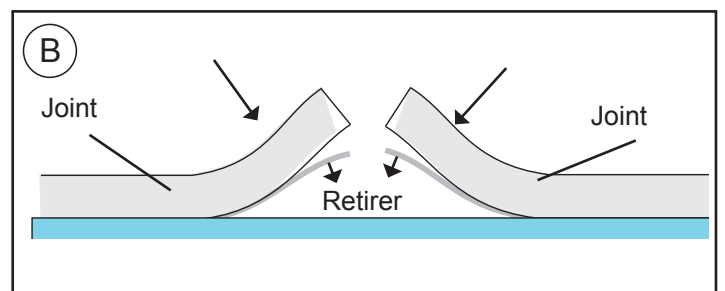
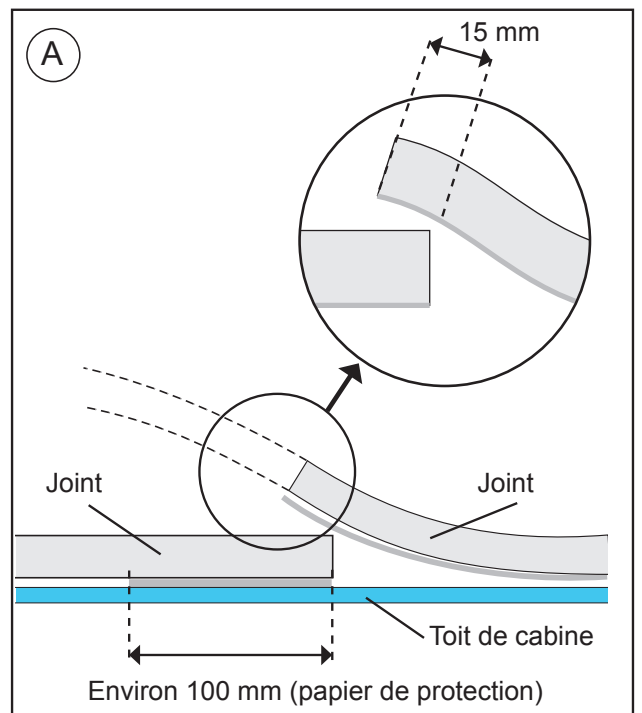

4 **EXTERIEUR CABINE:**
Positionner le **Compact** dans l'espace prévu.

Attention ! Avant de placer l'équipement sur le creux de l'écouille, vérifier que les sorties d'écoulement ne soient pas bouchées par le joint EPDM.

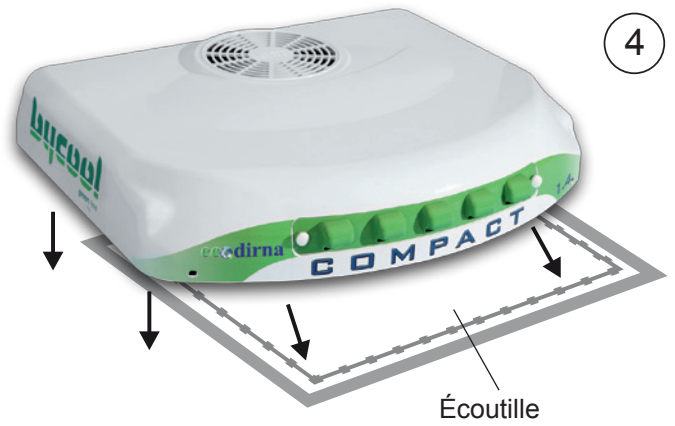

5 Placer le canalisateur en caoutchouc mousse en laissant la partie la plus molle sur la base de l'équipement.

Attention: en fonction de la cabine, il est possible de devoir utiliser les (2) canalisateurs fournis pour que le panneau de distribution d'air reste totalement ajusté avec ces derniers.

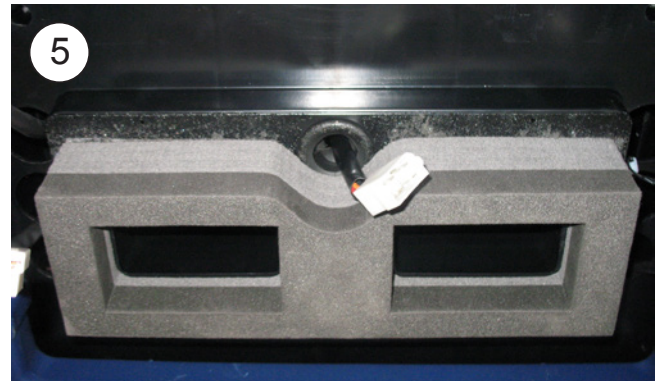

6 **INTERIEUR CABINE:**
Visser 5 mm environ (4) goujons de 8/125x 100 ou 120 mm, en fonction de la distance plus ou moins grande de l'appareil jusqu'à ce qu'en positionnant les supports de fixation, il ne reste que 20 mm au-dessous de ces supports.

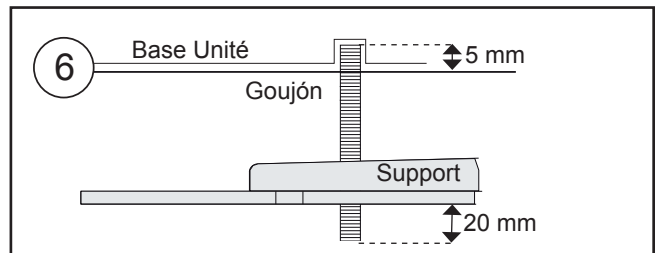

7 en suivant cet ordre :

- rondelle a mousse
- rondelle plain diamètre 8 aile large
- écrou M8
- plain rondelle diamètre 8 aile large

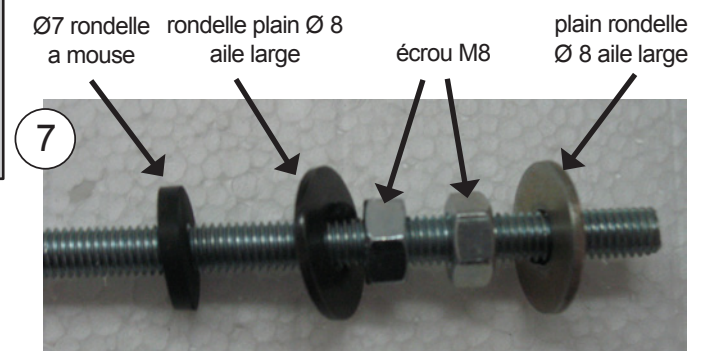

8

Placer les supports de fixation (2), avec une rondelle (1) et un écrou autobloquant (1) M8, sans serrer.

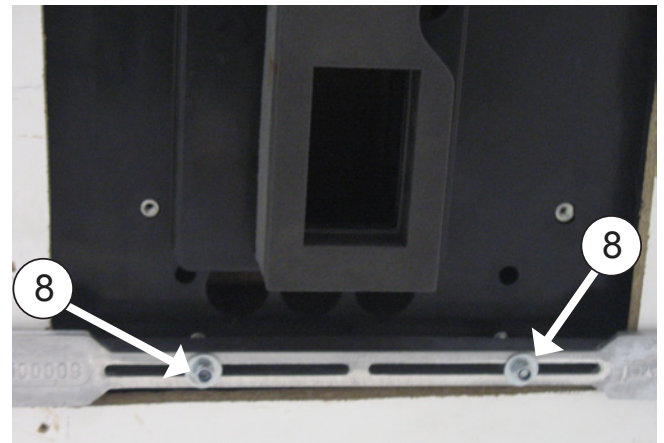
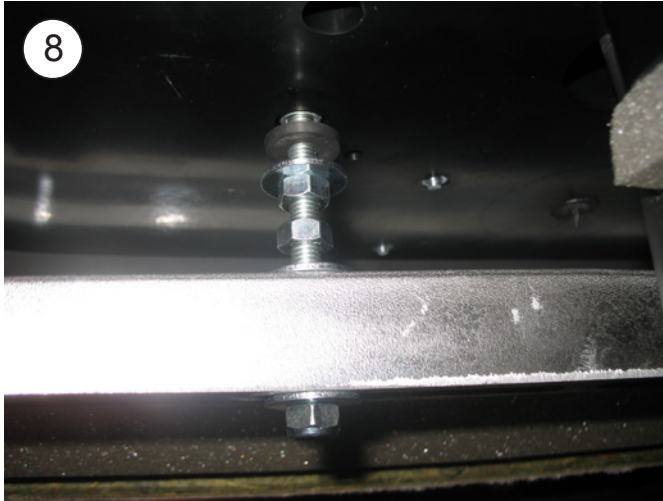
**9**

Visser 10 mm les goujons (4) M6 x 80, comme indiqué au (D) du schéma point 16.

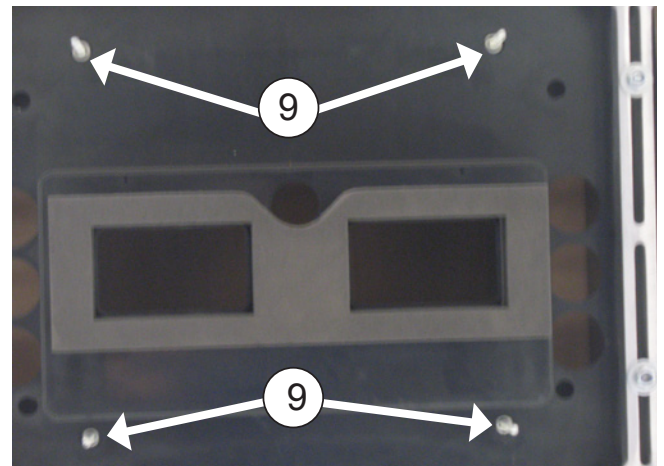
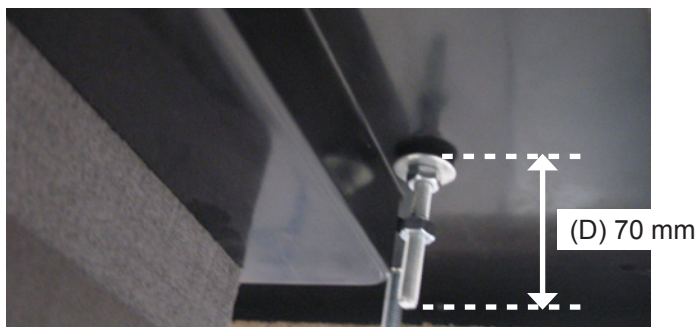
**10**

Placer (1) rondelle mousse diamètre 6 (1) plain rondelle diamètre 6 aile large et (1) écrou M6 sur chacun des asperges M6. En suivant serrer l'écrou jusqu'au la rondelle à mousse reste un peu pressée.

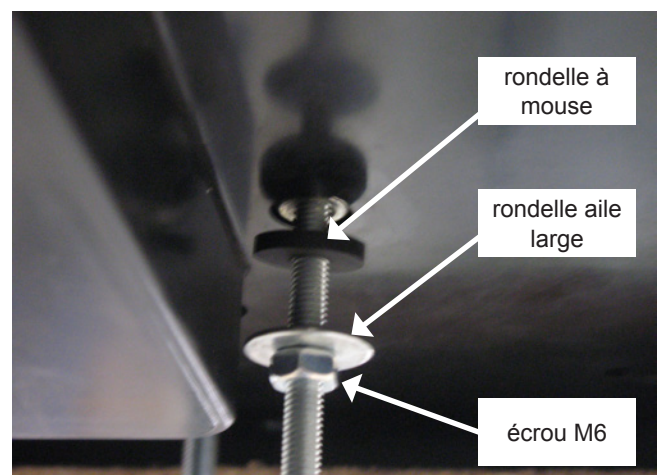

10a Placer l'écrou (1) M6 sans le serrer sur chaque goujon.

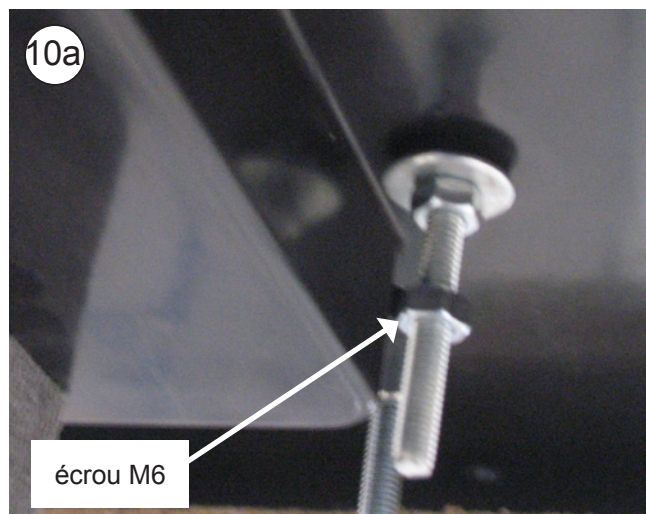

10b Connecter le boîtier à 2 voies du capteur de l'air de retour, le boîtier à 4 voies du souffleur et celui à 8 voies de connexion des câblages du contrôle électronique.

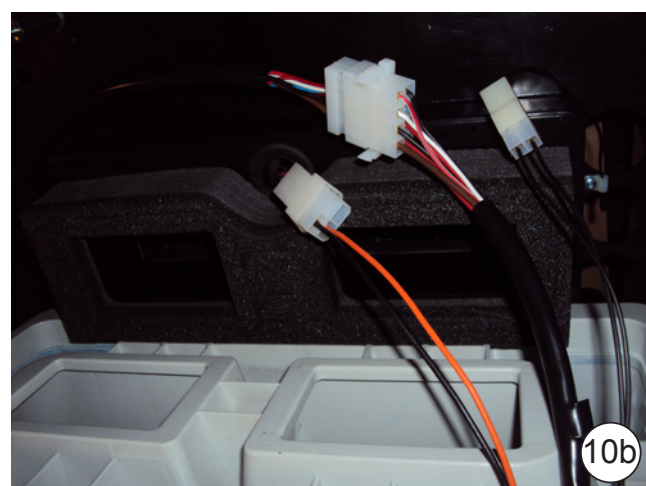

11

Placer le panneau intérieur de distribution d'air dans les goujons précédents avec (1) rondelle M6 surface large et (1) écrou M6 sur chaque goujon. Serrer les écrous jusqu'à ce que le canalisateur du panneau intérieur de distribution d'air heurte le caoutchouc mousse supérieur de l'équipement.

Important : les canalisateurs du panneau intérieur de distribution d'air doivent heurter le caoutchouc mousse supérieur de l'équipement pour éviter des fuites d'air.

Attention de ne pas coincer les câblages entre le canalisateur et le caoutchouc mousse placé dans la base de l'équipement.

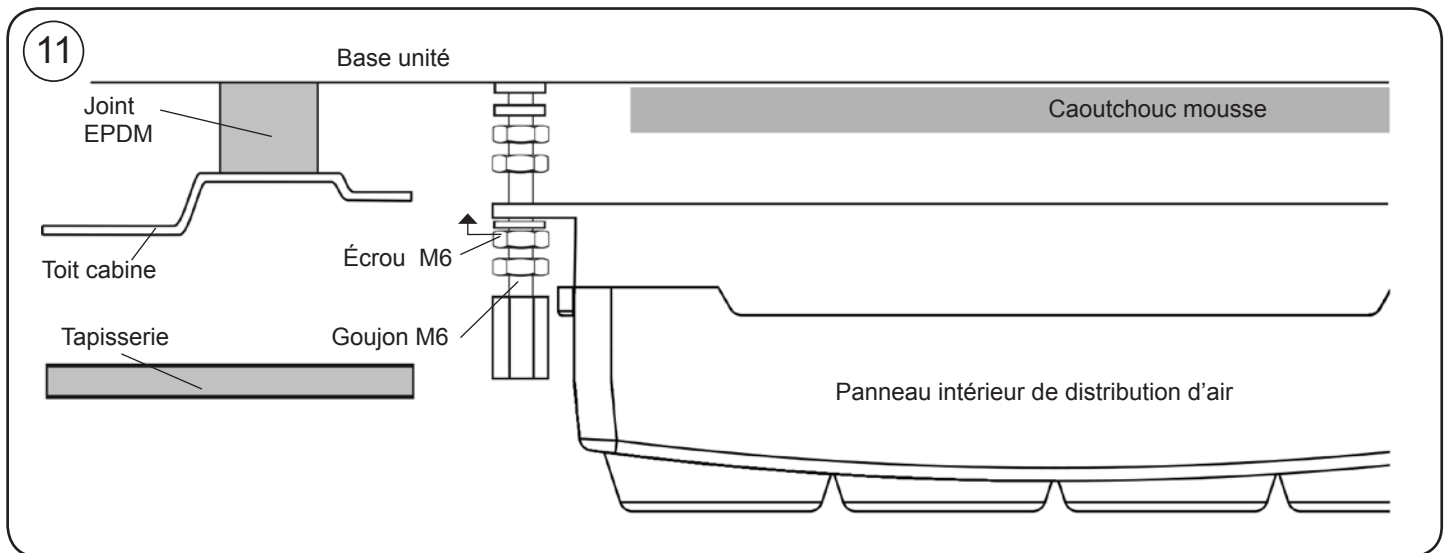

12

Apretar tuerca del punto 10a hasta hacer tope con la parte superior del panel interior de distribución de aire.

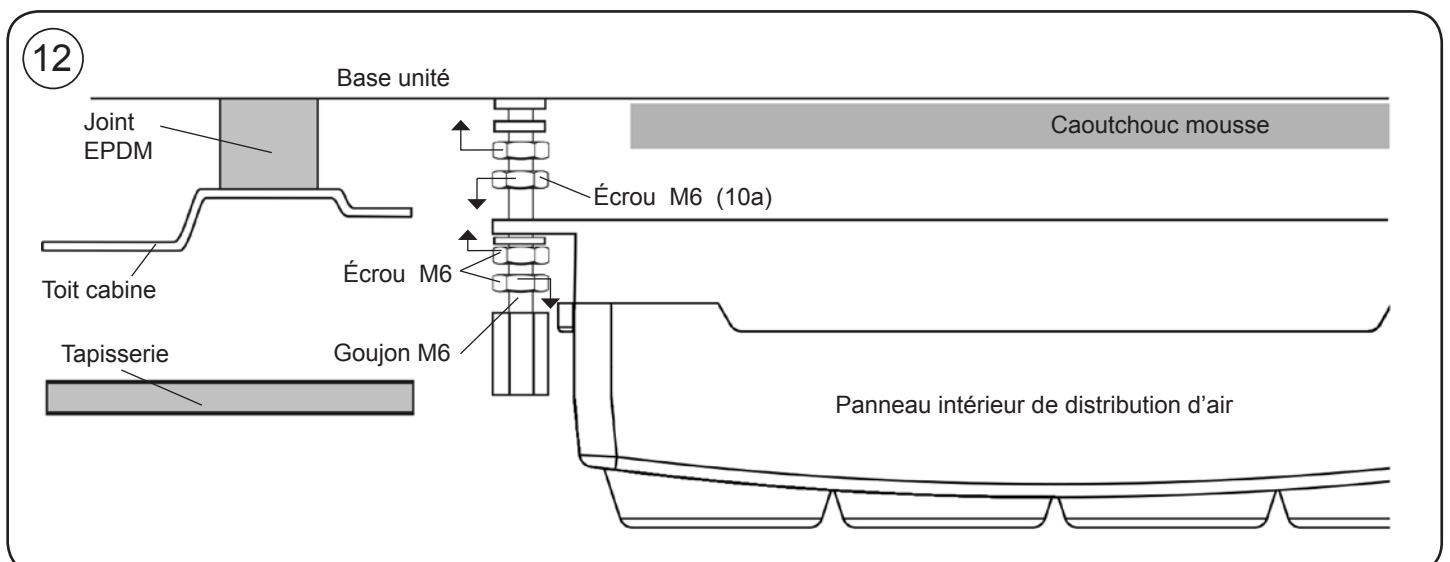

13

Placer la console et centrer l'appareil sur la partie convenant le mieux du toit de la cabine. Une fois centrée, retirer la console pour l'installer plus tard.

14

Fixer les supports en serrant les écrous jusqu'à serrer le joint EPDM de l'appareil entre 3 et 6 mm;

Important: Pour éviter la filtration d'eau dans la cabine, vérifier le serrage du joint EPDM à la base du **Compact**, comme indiqué sur le **diagramme**.

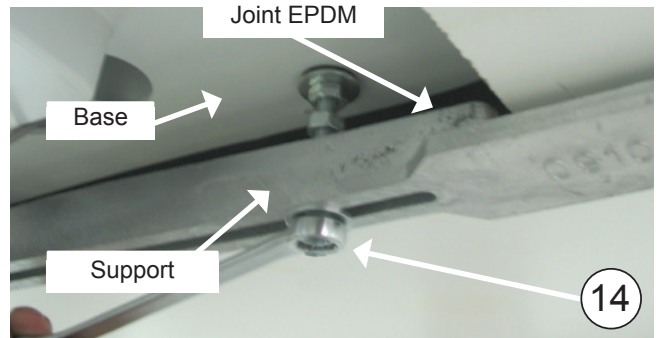
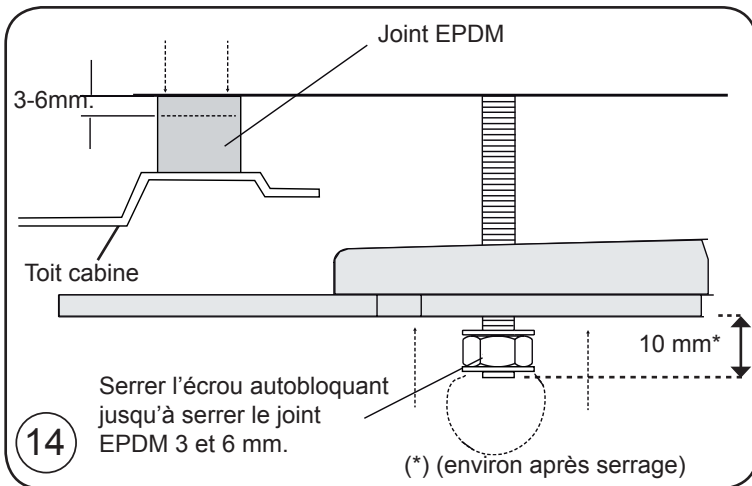

15

Serrer les écrous (4) M8 afin de fixer à (4) l'unité base.

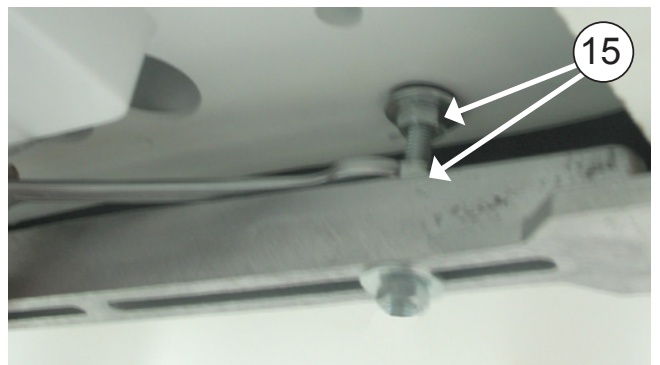

16

Placer un écrou M6 (A) après l'écrou de fixation du panneau intérieur de distribution d'air dans chaque goujon. Placer les hexagones M6 en vissant jusqu'à ce qu'il reste 1 mm au-dessus de la tapisserie. Dévisser les écrous M6 (A) de ce point jusqu'à atteindre les hexagones et serrer contre eux.

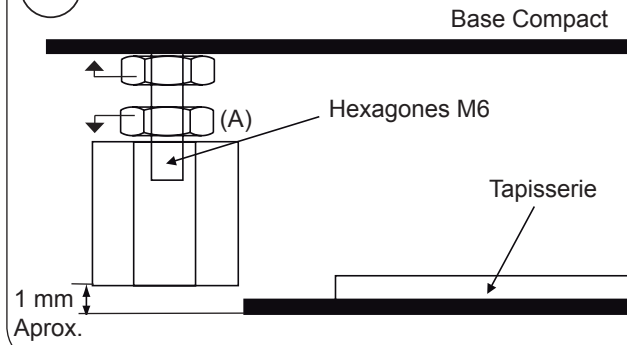
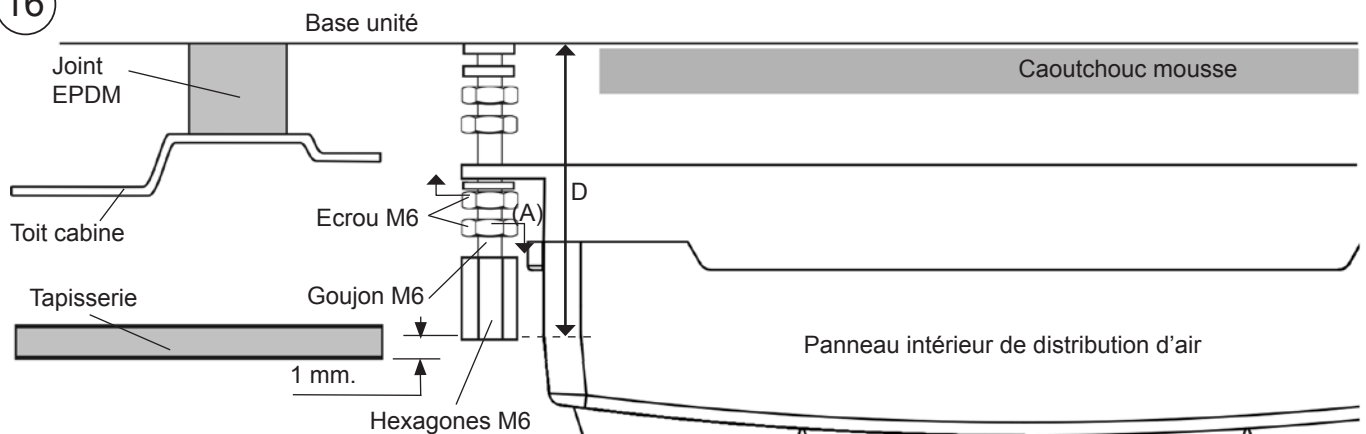
16**16****17**

Placer la console à l'aide des (4) vis Allen M6/100x15.

17**17**

18 Couvrir les têtes des vis Allen (4) M6/100x15 avec les capuchons en plastique M6.



Vue explosée jusqu'à la fixation des supports de fixation

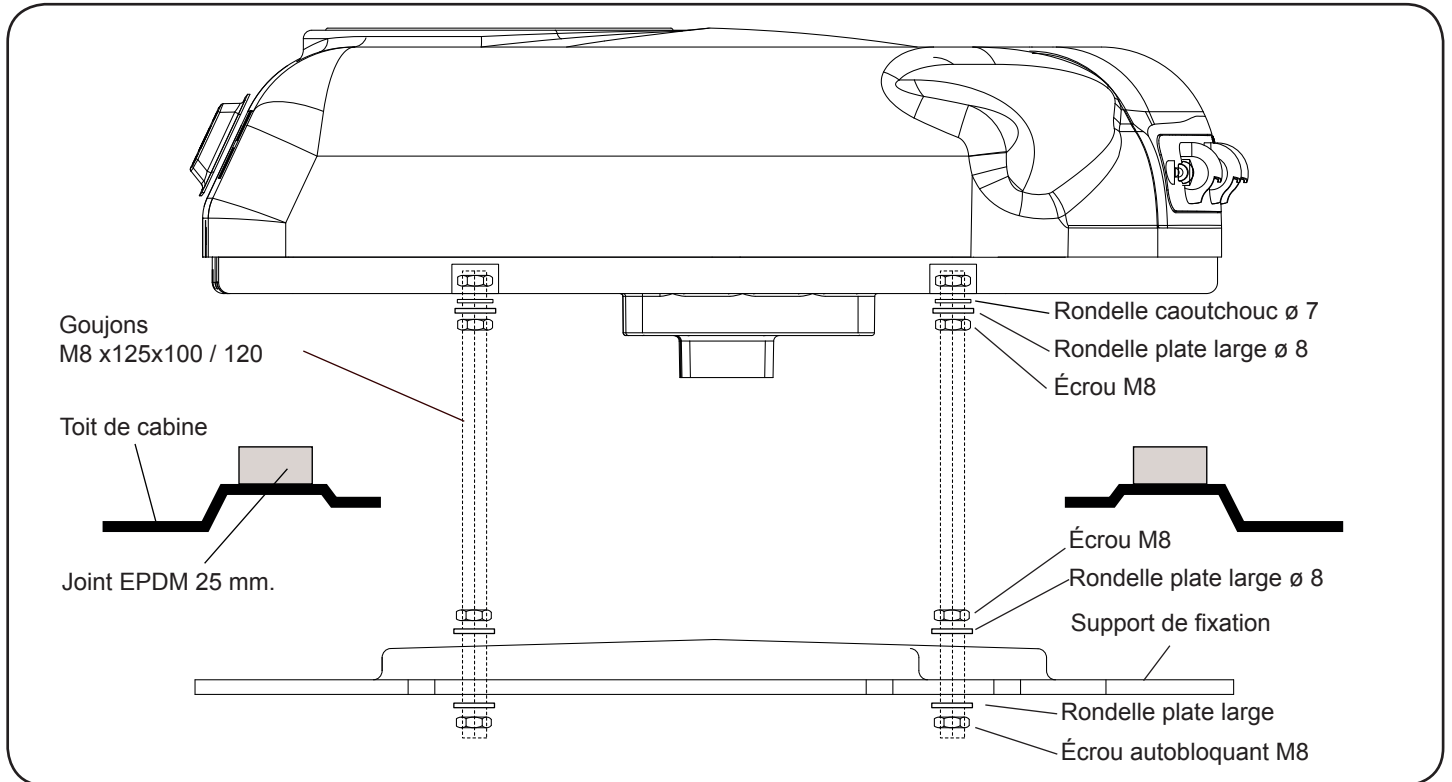

Vue explosée jusqu'à fixation des consoles

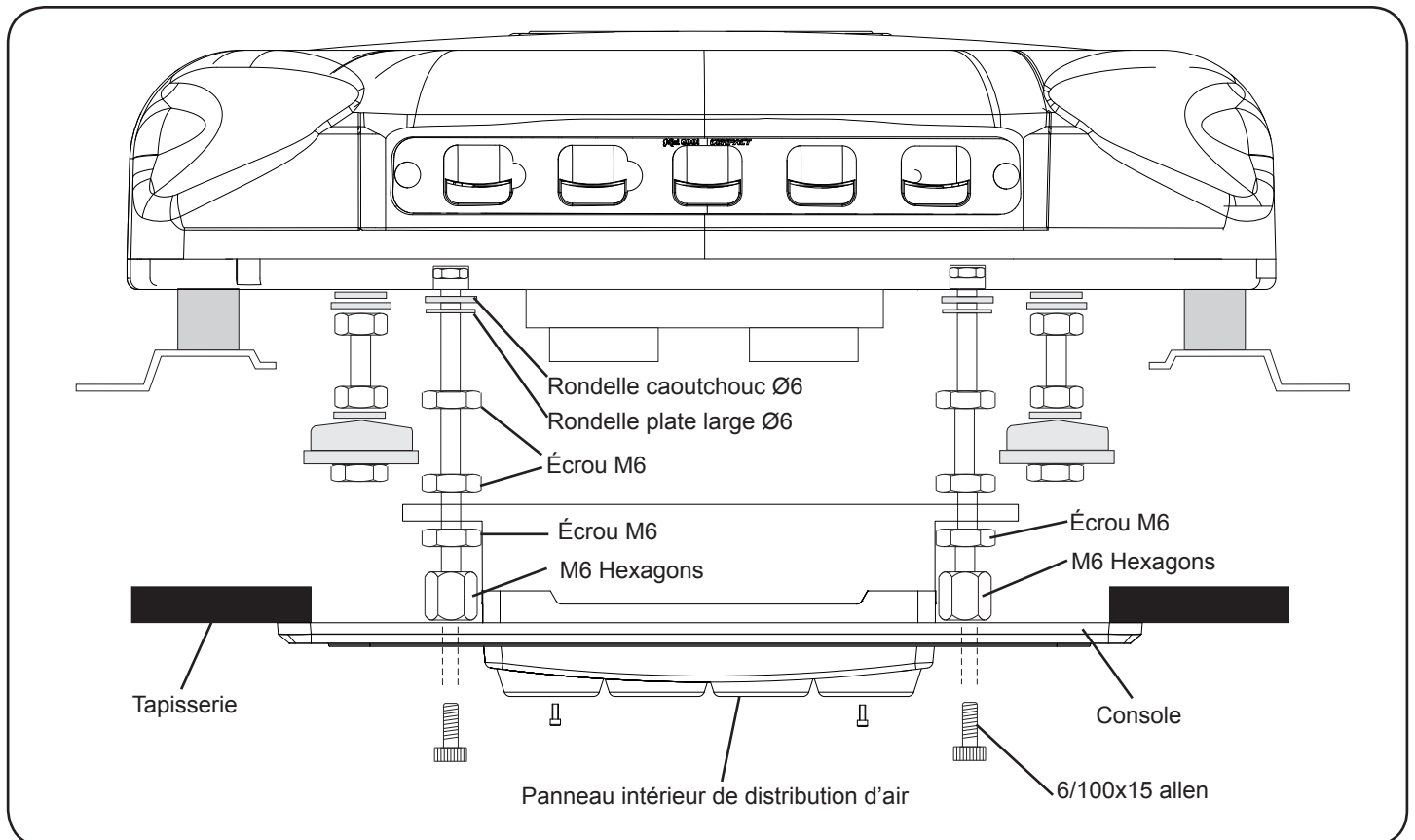

Instructions détaillées sur l'installation du câblage d'alimentation



Câblage d'alimentation



1- Conduire le câble d'alimentation de l'équipement jusqu'à la batterie du véhicule, en collant les supports de plastique sur la partie postérieure de la cabine et en le fixant avec des brides. Ensuite, la cabine étant rabattue, passer le câble le long de la partie inférieure de celle-ci en l'attachant avec des colliers et des vis M4 et jusqu'à la batterie avec des brides. Il faut utiliser le même passage que celui du câblage d'origine (*pour coller les supports en plastique, bien nettoyer la zone préalablement*). Lorsque l'équipement sera connecté à la batterie, celui-ci testera tous ses leds, puis sera affiché sur le **88--bd** et s'éteindra.

IMPORTANT: dû au système complexe de régulation électronique de l'équipement, le courant doit être directement pris de la batterie du véhicule, et non pas de tout autre point alimentant d'autres accessoires du véhicule, en prenant soin de ne pas inverser la polarité au moment de la connexion (2). Si la polarité est inversée, la plaque de commande ne s'allumerait pas et l'équipement ne fonctionnerait pas.

IMPORTANT: pour la mise en marche, consulter le Manuel de l'Utilisateur.



Câblage électrique

AVERTISSEMENT IMPORTANT!

Attention de ne pas inverser les polarités au moment de connecter l'équipement à la batterie. Si cela se produisait, la plaque de commande ne s'allumerait pas et l'équipement ne fonctionnerait pas.

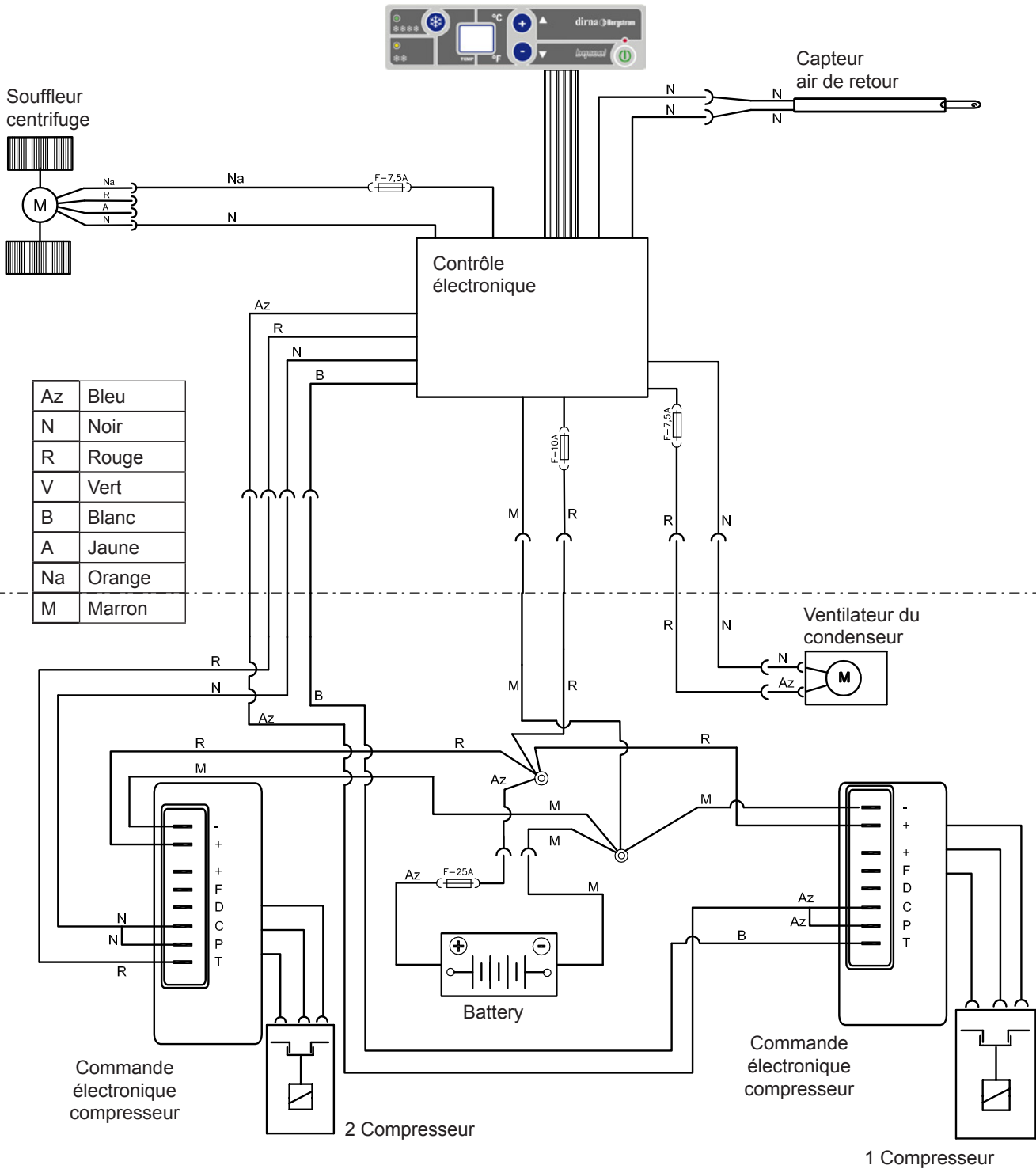

Empfehlungen Zur montage

- Vor und während der Montage bitte diese Anweisungen lesen und beachten.
- Benutzen Sie für jeden Arbeitsschritt die geeigneten Werkzeuge.

Elektrizität

- Zündschlüssel abziehen.
- Vor Montagebeginn die Batterie abklemmen.
- Den ordnungsgemäßen Anschluss und die korrekte Installation der Elektrokomponenten überprüfen.

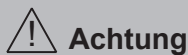

Achtung

Sollte sich das Gerät während der Montage neigen, muss man mindestens 60 Minuten warten, nachdem es wieder in die horizontale Lage gebracht wurde, um es wieder einzuschalten.



Achtung

Wird die Klimaanlage im Kabinendach installiert, muss der obere Teil der Kabine mit einem Tuch oder einer Decke gegen eventuelle Kratzer geschützt werden. Bei der Installation der **Compact** auf dem Kabinendach muss darauf geachtet werden, dass mit Luken ausgestattete Kabinen über eine ausreichend stabile Struktur verfügen, um das Gewicht des Geräts stand zu halten. Sollte das Fahrzeug über keine Luke verfügen und sollte es notwendig sein, das Kabinendach aufzuschneiden, bzw. sollte die vorhandene Struktur nicht ausreichend stabil sein (z.B. wenn sie aus Faser, Kunststoff usw. hergestellt ist), obliegt es dem Installateur zu entscheiden, ob das Kabinendach zur Vermeidung von Verformungen, Brüchen, undichten Stellen usw. verstärkt werden muss, und die hierfür notwendigen Mittel bereit zu stellen.

Werkzeuge

- Torx-Schraubenschlüssel
- Inbusschraubenschlüssel
- 10er, 13er, 14er Schraubenschlüssel
- Schere
- Metermaß

Mitgelieferte unterlagen

Montageanweisungen	1001207466
Benutzerleitfaden	1001204545
Fehlerdiagnose	1001204543
Garantie	220AA10017

Symbologie



Fragile



Attention aux coupures !



Risque électrique



Warnhinweise



Der Installateur muss im Bereich Fahrzeug-Klimaanlagen ausreichend geschult sein.



dirna Bergstrom, s.l. übernimmt keine Verantwortung für Schäden oder Brüche aufgrund einer nicht ordnungsgemäßen Installation oder Bedienung des Geräts oder den Austausch von Teilen bzw. Umbauten, die ohne die erforderliche schriftliche Genehmigung durchgeführt wurden.



Mit Kältemittel vorgefülltes Gerät, R-134a. (Kältemittelkreislauf nicht manipulieren).



Siehe **Garantieverfahren** des Produkts in der **Fehlerdiagnose**.



Siehe **Benutzerleitfaden** des Geräts für den ordnungsgemäßen Betrieb der Fernbedienung und des Bedienfelds.



Die folgenden Unterlagen müssen dem Benutzer nach der Installation ausgehändigt werden: **Benutzerleitfaden, Garantie** und **Fehlerdiagnose**.

 Vor Montabeginn vorderes Lufteintrittsgitter montieren.



1 Den Lukendeckel und die Befestigungselemente entfernen und dem Kunden aushändigen (*).

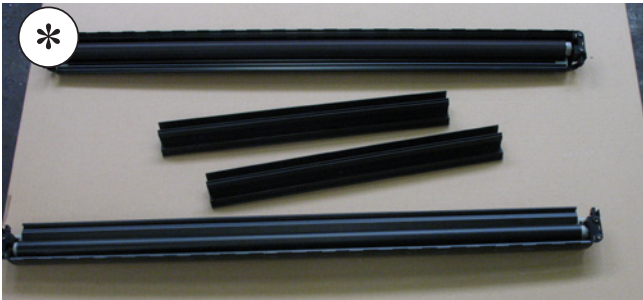

2 Vor dem Ankleben der EPDM-Dichtung die Klebstoffreste von der oberen Kabinenfläche entfernen.

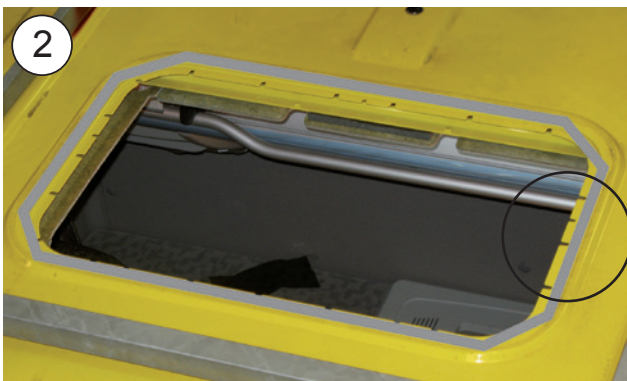

3

Die EPDM-Dichtung um die Lukenöffnung herum ankleben (siehe Detailansicht für das Schneiden der Ränder).

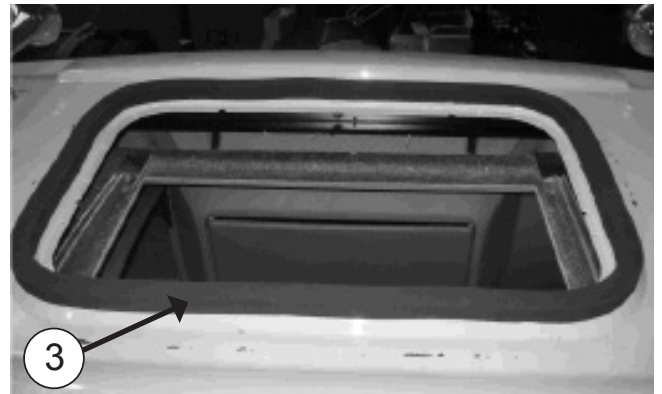

WIE DIE EPDM-DICHTUNG GESCHNITTEN WIRD, UM FILTRATIONEN IN DER KABINE ZU VERMEIDEN

- A- Dichtung aufkleben und dabei einen Papierschutz von 100 mm auf jeder Seite beibehalten.
- B- Die zwei Papierstücke entfernen.
- C- Unter Anpressen beider Enden aufkleben.

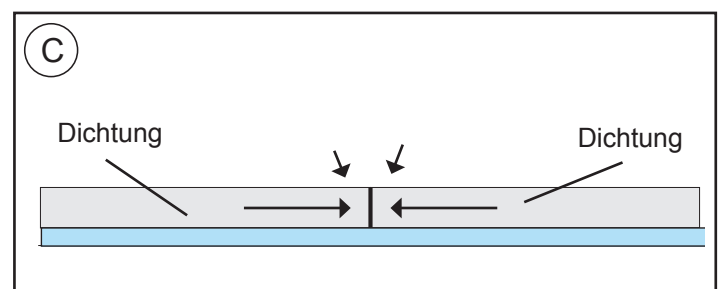
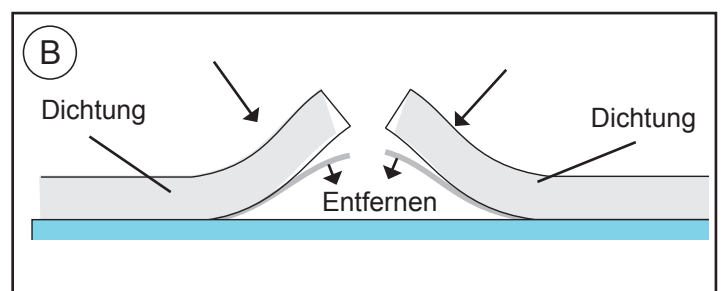
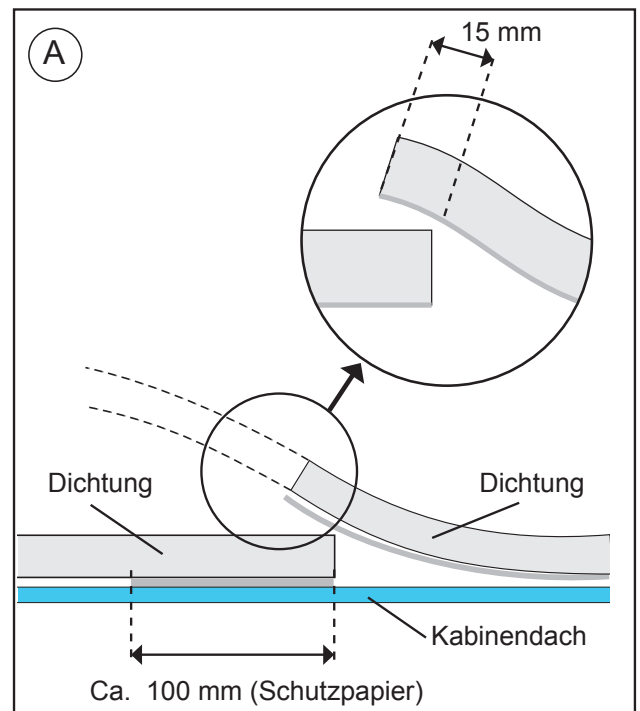

4 **KABINENAUSSENSEITE:**
Compact in der Öffnung positionieren.

Achtung! Beim Auflegen des Geräts auf die Lukenaussparung darauf achten, dass die Ablassausgänge nicht von der EPDM-Dichtung zusammengedrückt werden.

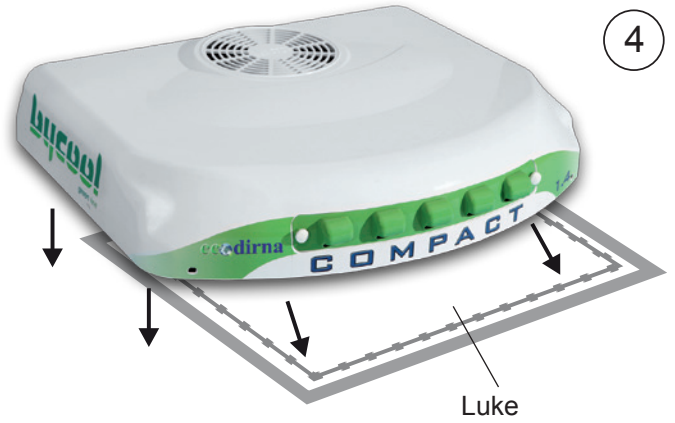

5 Schaumgummidurchführung anbringen, wobei der weichere Teil auf der Gerätegrundplatte aufliegt.

Achtung: Je nach Kabine kann es erforderlich sein, die (2) mitgelieferten Führungen zu verwenden, damit die Luftverteiltertafel ordnungsgemäß ausgerichtet ist.

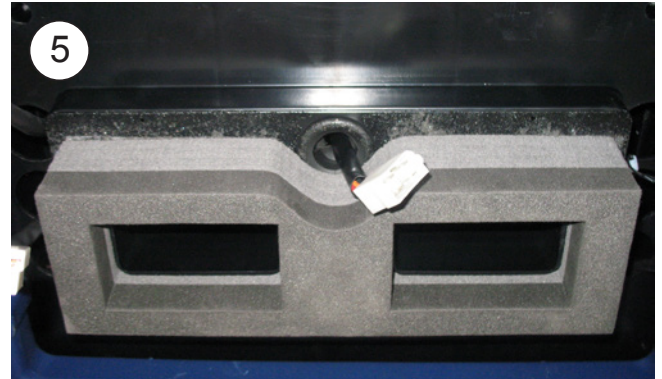

6 **KABINENINNENSEITE:**
Ca. 5 mm Gewinde für (4) Stiftschrauben 8/125x100 oder 120 mm schneiden (abhängig vom größeren oder kleineren Abstand vom Gerät bis sie nach Positionierung der Befestigungsauflagen 20 mm unter diesen liegen).

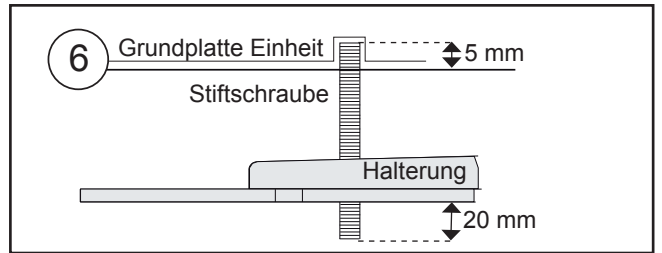

7 Montieren Sie wie folgt:
Gummischeibe / 3D Unterlegscheibe / Mutter / Gewindestange

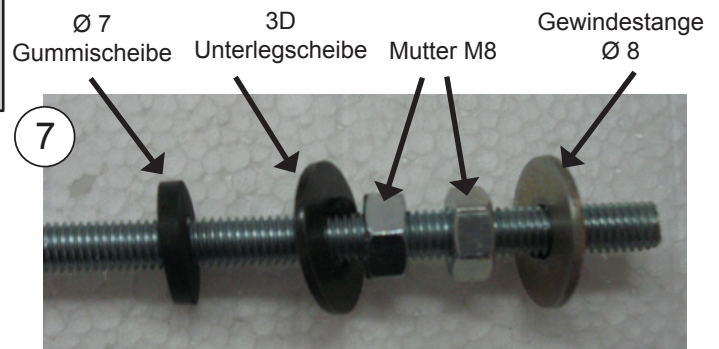

8 Befestigungsauflagen (2) mit einer Unterlegscheibe (1) und einer Autobloc-Mutter (1) M8 einlegen, **jedoch ohne anzuziehen**.

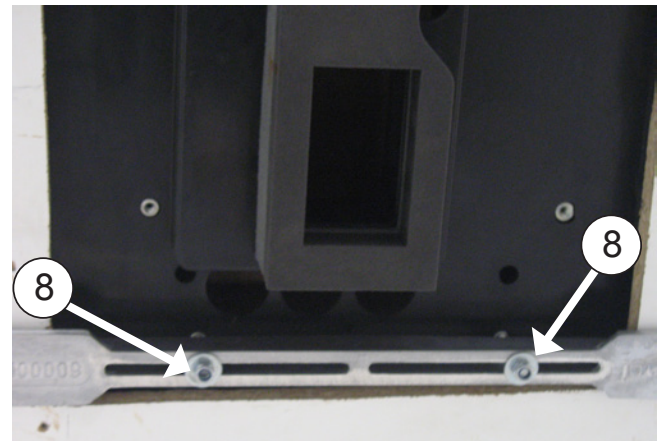
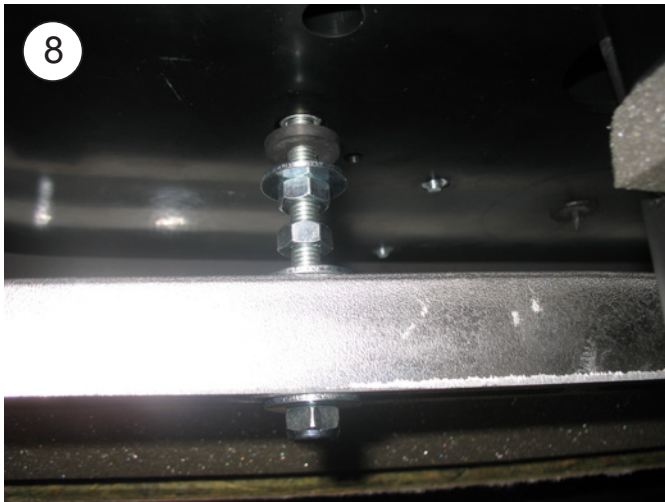

9 10 mm Gewinde für die Stiftschrauben (4) M6 x 80 am angegebenen Punkt schneiden laut Distanz (D) beschrieben in Abbildung 16.

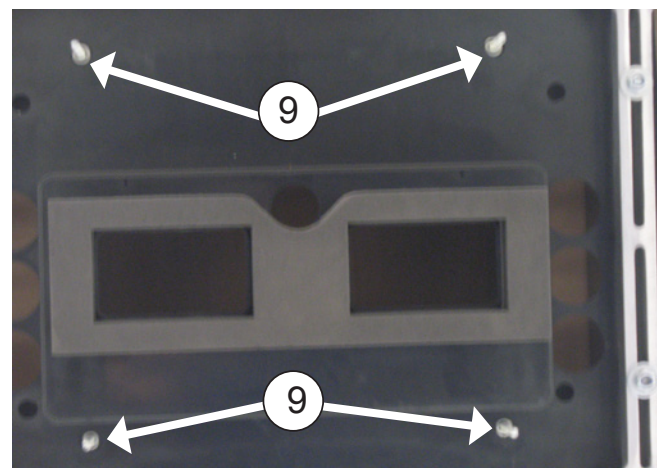
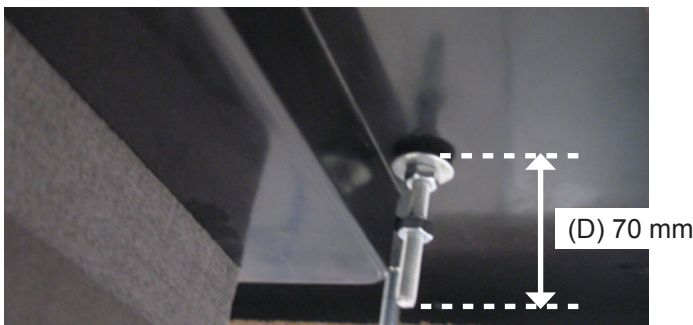

10 Montiere (1) Gummi-Unterlegscheibe, (1) 3D Unterlegscheibe (1) Mutter auf jede Gewindestange. Später ziehen Sie die Mutter an, bis die Gummischeibe ein wenig zusammengemisst ist.

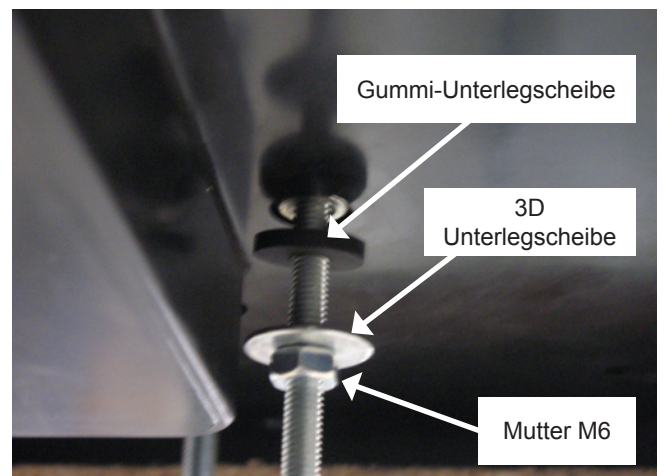

10a

Jeweils die Mutter (1) M6 **ohne Anziehen** auf die Stiftschrauben legen.

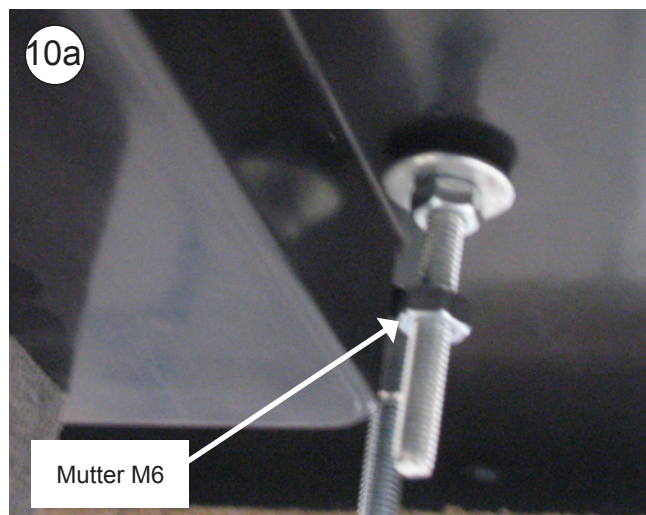
**10b**

Den 2-Wege-Kasten des Abluftensors, den 4-Wege-Kasten des Gebläses und den 8-Wege-Kasten der Kabel der Elektroniksteuerung anschließen.

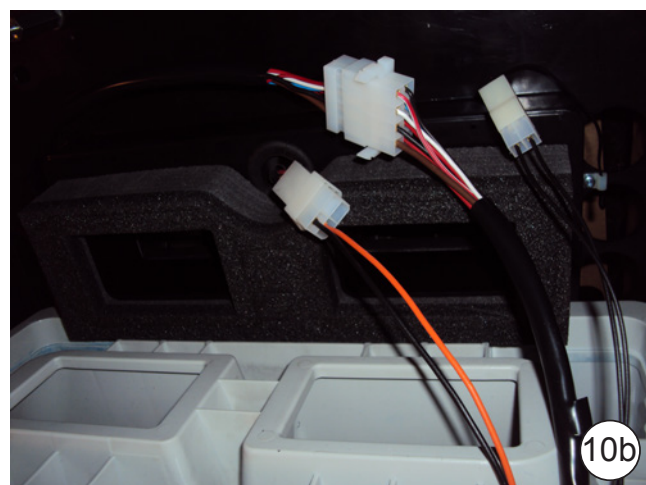

11

Innere Luftverteiltertafel an den vorgenannten Stiftschrauben mit jeweils (1) Breitflansch-Unterlegscheibe M6 und (1) Mutter M6 anbringen. Muttern anziehen, bis die Führung der inneren Luftverteiltertafel am oberen Schaumgummi der Anlage anschlägt.

Wichtiger Hinweis: Die Führung der inneren Luftverteiltertafel muss am oberen Schaumgummi der Anlage anschlagen, damit keine Luft austreten kann.

Darauf achten, dass die Kabel nicht zwischen Führung und Schaumgummi der Gerätegrundplatte eingeklemmt werden.

11

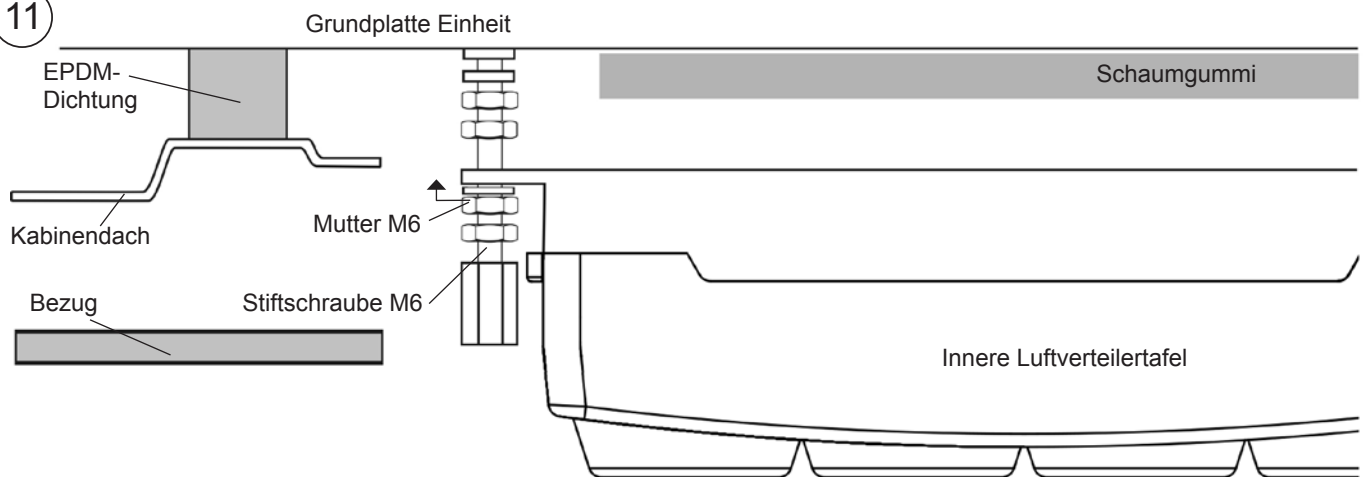

12

Apretar tuerca del punto 10a hasta hacer tope con la parte superior del panel interior de distribución de aire.

12

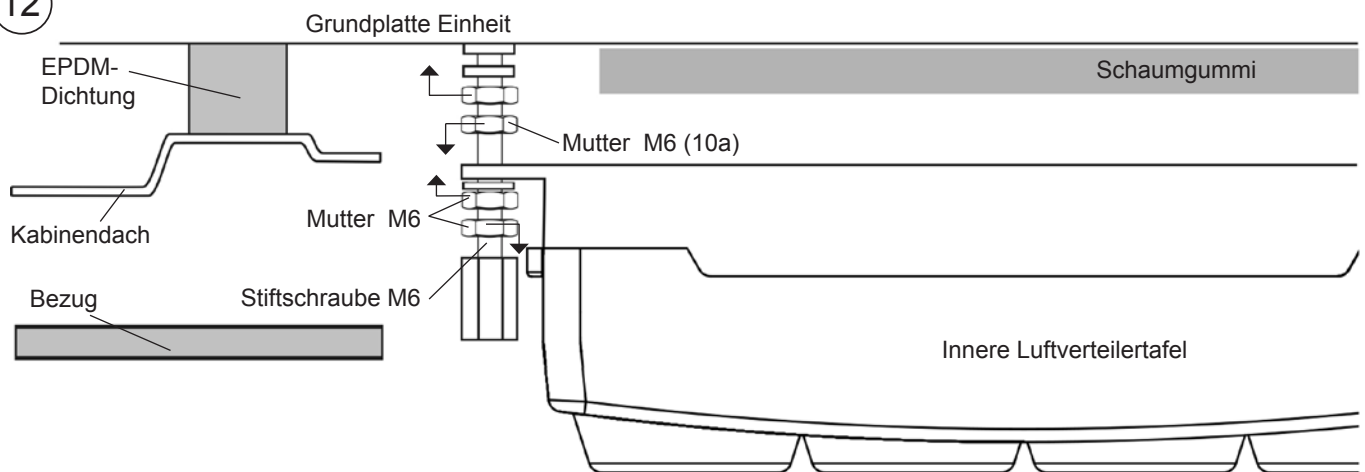

13

Die Konsole aufsetzen und das Gerät an der am besten geeigneten Stelle des Kabinendachs zentrieren. Nach der Zentrierung die Konsole für die nachfolgende Montage abnehmen.

14

Die Halterungen durch Anziehen der Muttern befestigen, bis die EPDM-Dichtung des Geräts zwischen 3 und 6 mm komprimiert wird;

Wichtiger Hinweis: Um das Eindringen von Wasser in die Kabine zu verhindern, die die Verbindung der EPDM-Dichtung mit der Grundplatte des Compact wie in **Schema** gezeigt überprüfen.



Die Komprimierung der EPDM-Dichtung überprüfen anhand eines Stahlbaudmaßes in den vier Ecken.

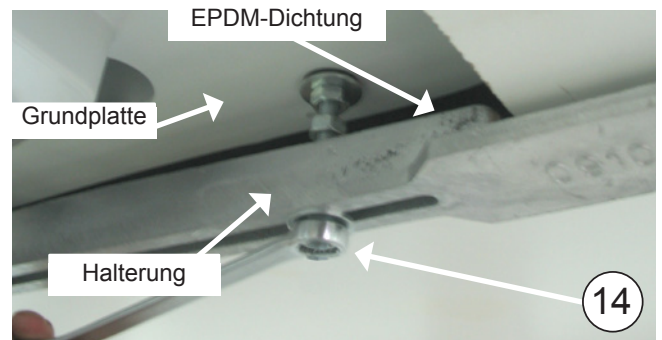
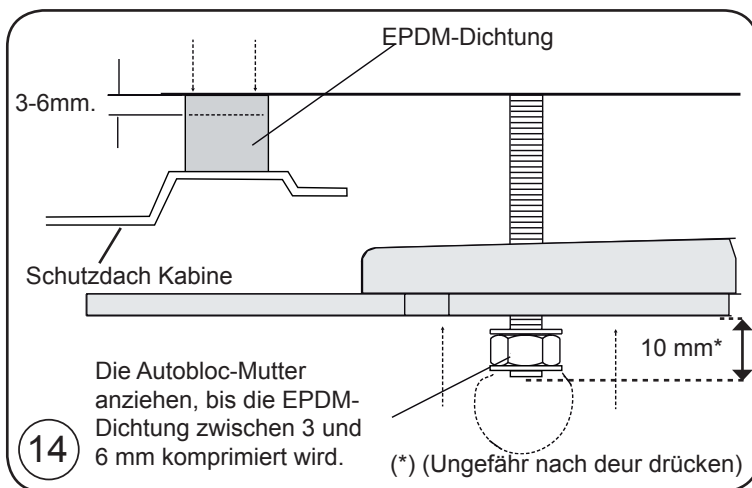

15

Die Muttern (4) M8 anziehen, um sie an der Grundplatte zu befestigen.

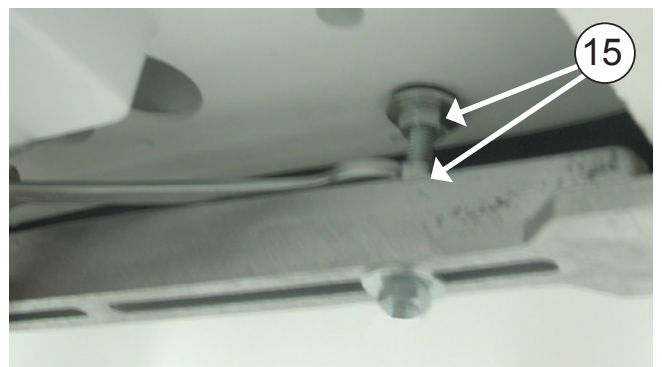

16

Eine Mutter M6(A) hinter der Befestigungsmutter der inneren Luftverteiltertafel an allen Stiftschrauben anbringen. Sechskant-Verbindungs-muttern M6 eindrehen, bis sie 1 mm über dem Bezug herausstehen. Muttern M6 (A) dieses Punkts herausschrauben, bis sie an die Sechskant-Verbindungs-muttern anstoßen, und gegen diese anziehen.

16

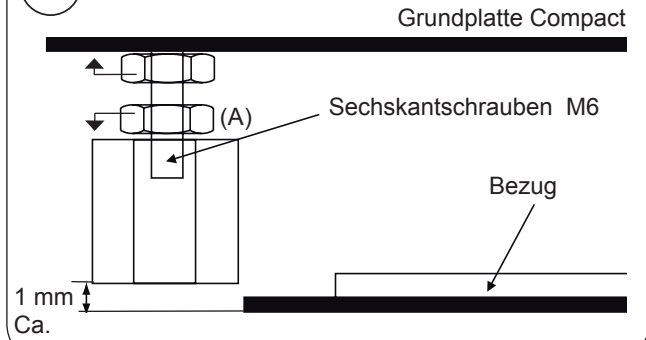

16

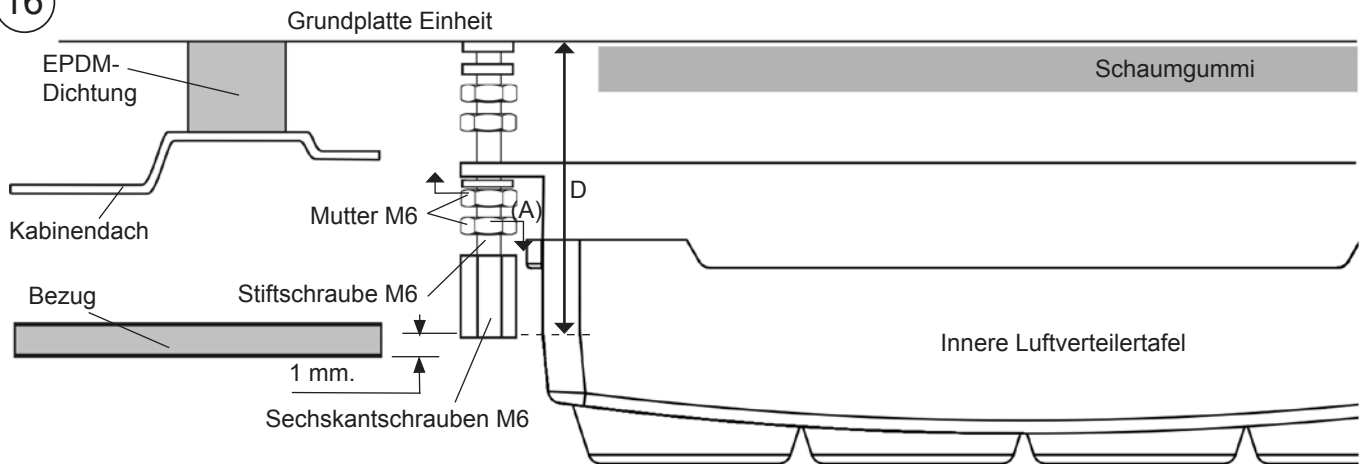

17

Die Konsole anhand von (4) Inbusschrauben M6/100x15 anbringen.

17



17



18 Die Köpfe der Inbusschrauben (4) M6/100x15 mit Kunststoffkappen M6 abdecken.



Explosionsansicht bis zur befestigung der befestigungsauflagen

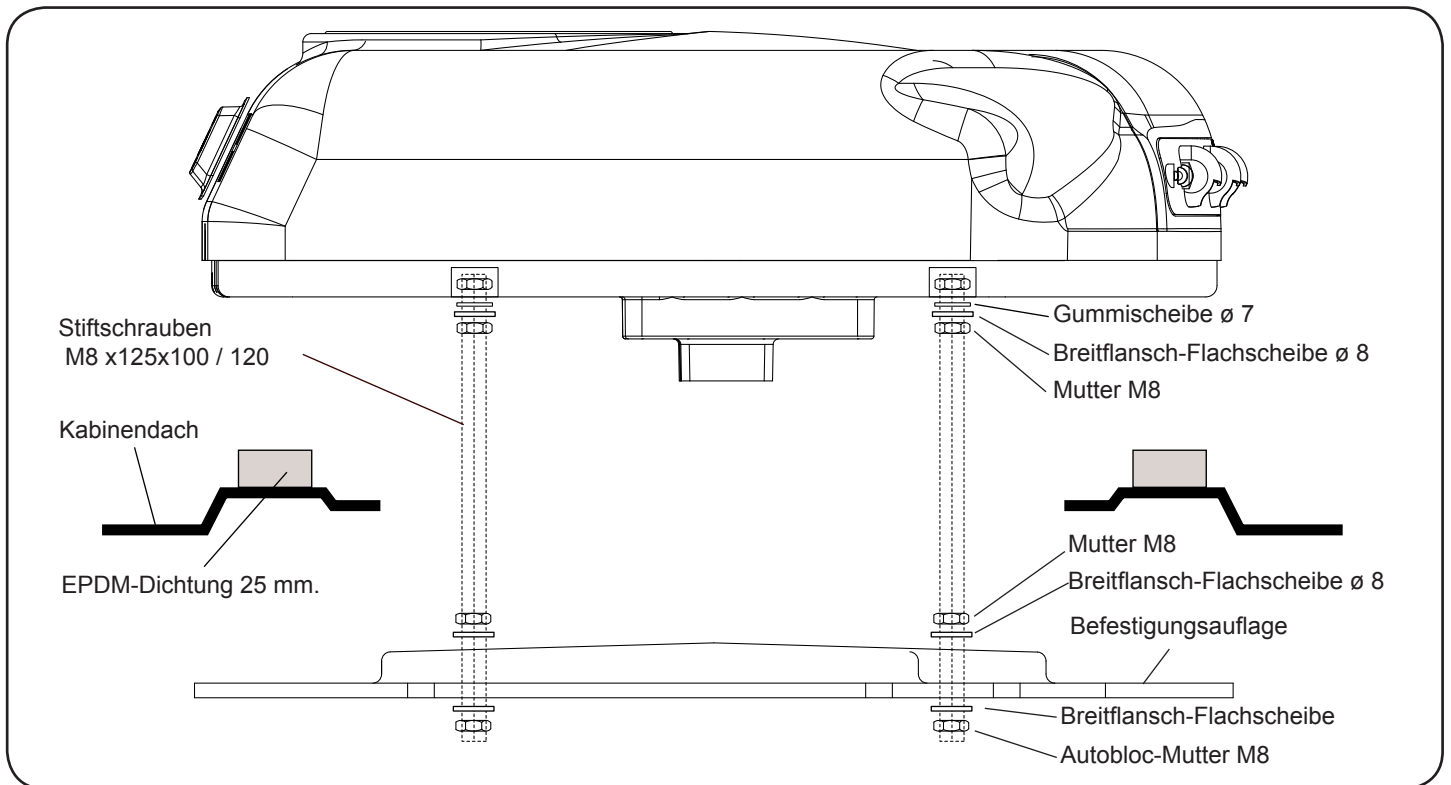

Explosionsansicht bis zur befestigung der konsolen

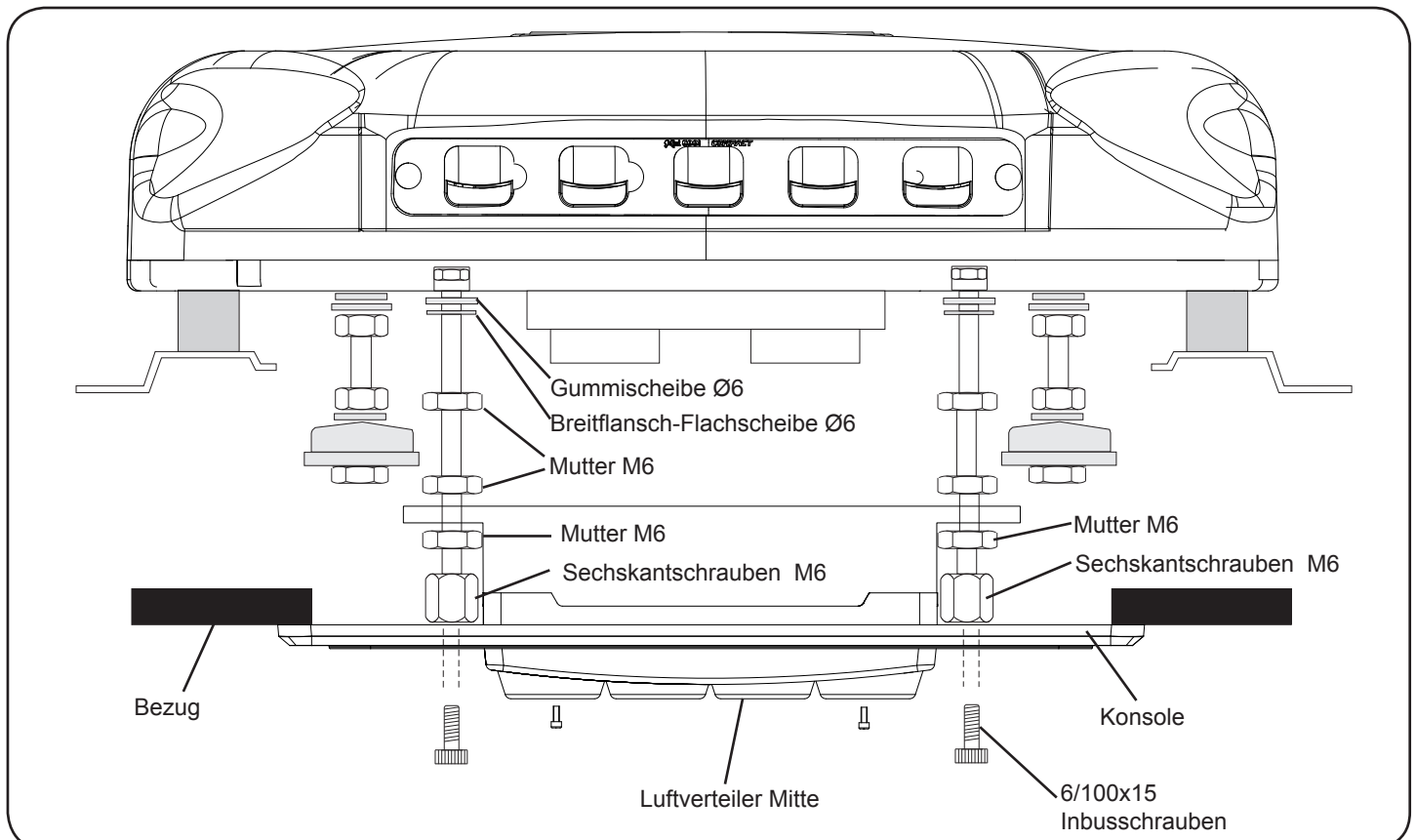

Ausführliche Anleitung für die Installation der Spannungsversorgung



Spannungs-
versorgungskabel

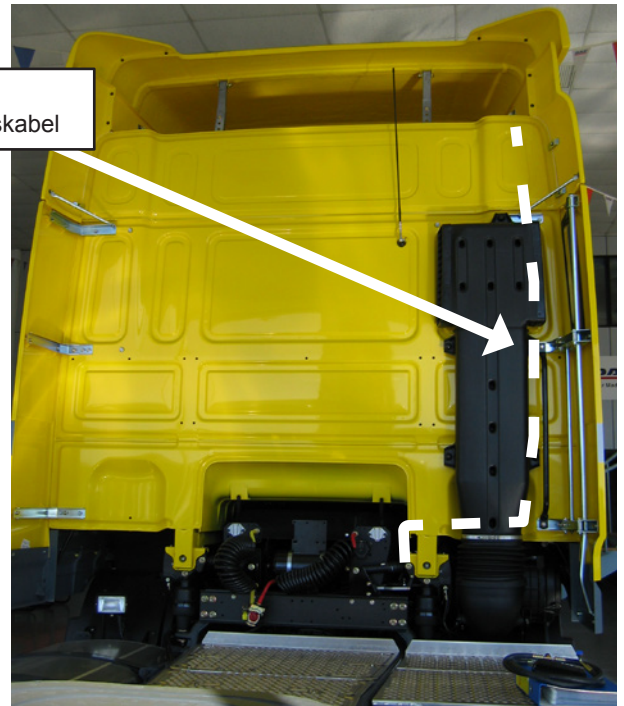

1- Führen Sie bitte das Spannungsversorgungskabel der Anlage bis zur Batterie des Fahrzeugs, befestigen Sie dieses anschließend mit Plastikhalterungen/Kabelbindern an der Rückseite der Kabine. Anschließend verlegen Sie das Versorgungskabel unter der angekippten Fahrerkabine bis nach vorne zum Knickpunkt. Von da an verlegen Sie das Versorgungskabel im Fahrgestell bis zur Batterie. Befestigen Sie das Versorgungskabel mit M4 Schrauben und Plastikhalterungen/Kabelbindern. (Um die Plastikhalterungen anzukleben, bitte zuvor gut die zu beklebende Zone dementsprechend säubern). Beim Anschließen der Anlage an die Batterie des Fahrzeugs werden alle LED's angesteuert, damit diese geprüft werden können. Dann erscheint im Display **88--bd** und blendet sich wieder aus.

WICHTIG: Durch das intergierte Spannungsüberwachungssystem der Anlage, muss die Spannungsversorgung direkt an der Batterie des Fahrzeugs erfolgen. Die Spannungsversorgung darf nicht an irgendeinen anderen Punkt des Fahrzeugs abgegriffen werden, da andere Zubehöre dort angeschlossen sein können. Es muss außerdem darauf geachtet werden, die Polarität beim Anschließen nicht zu verwechseln. Wenn die Polarität umgekehrt angeschlossen wird, können nicht zu reparierende Schäden in der Elektronik auftreten, schaltet sich das Bedienfeld nicht ein und das Gerät funktioniert nicht.

WICHTIG: Für die Inbetriebnahme lesen SieBitte genau die Vorschriften im Benutzerhandbuch.

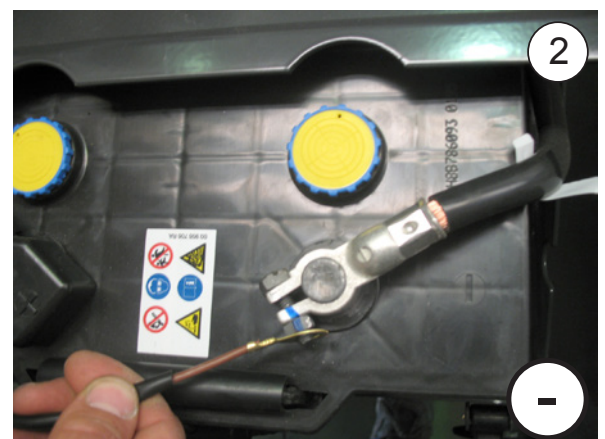

Elektrische Verkabelung

WICHTIGER WARHNHINWEIS!

Achten Sie darauf, die Polaritäten beim Anschluss der Anlage an die Batterie nicht zu vertauschen. Ist dies der Fall, schaltet sich das Bedienfeld nicht ein und das Gerät funktioniert nicht.

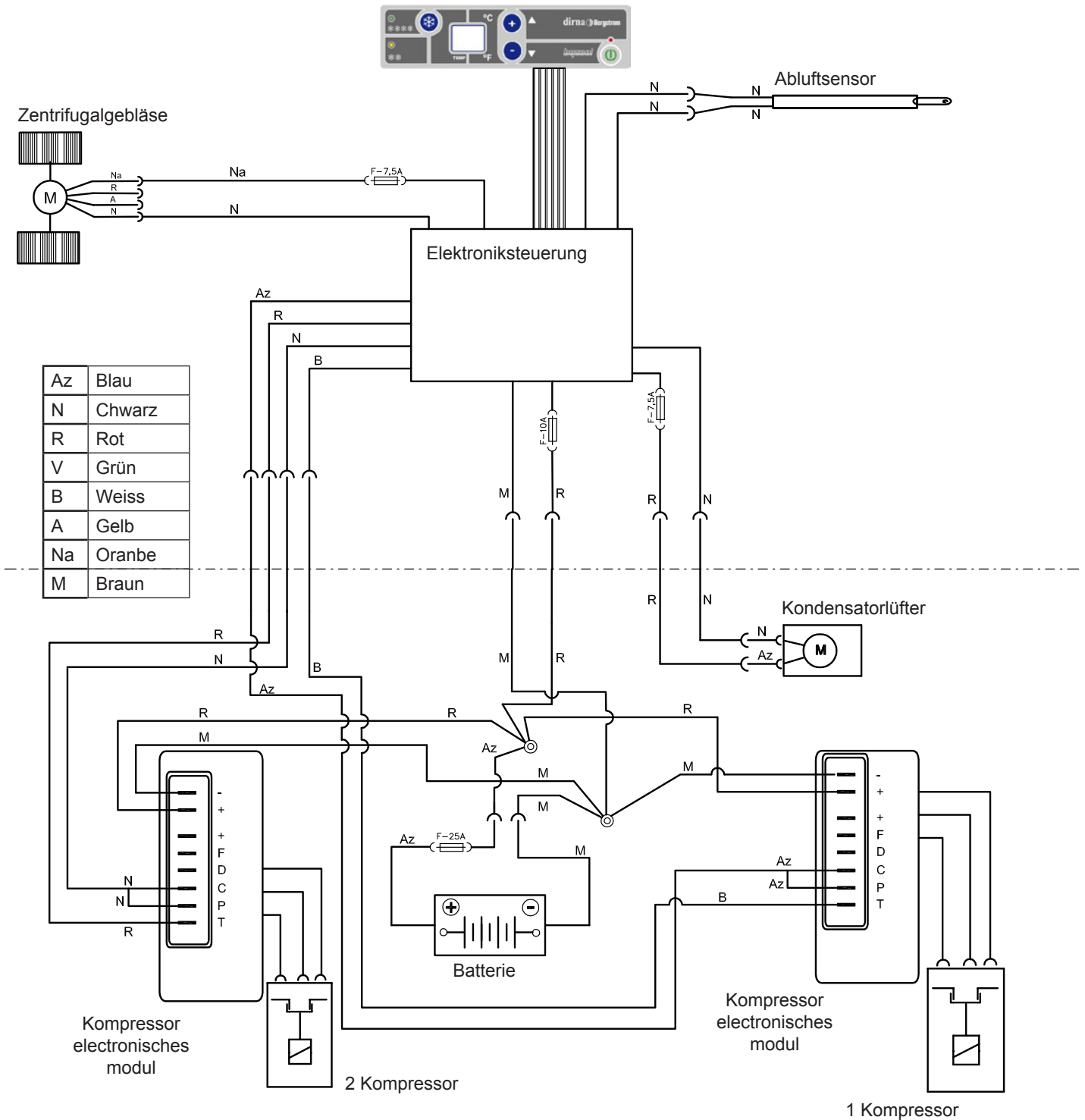

Suggerimenti per il montaggio

- Prima di cominciare il montaggio, leggere attentamente le istruzioni e rispettarle nel corso dello stesso.
- Usare gli attrezzi più adatti ad ogni operazione.

Elettricità

- Scollegare la chiave di contatto.
- Scollegare la batteria prima di cominciare il montaggio.
- Assicurarsi di avere effettuato correttamente l'installazione e il collegamento dei componenti elettrici.

Attenzione

Se durante il montaggio si inclina l'impianto, prima di rimetterlo in funzione occorre attendere almeno 60 minuti dal momento in cui è di nuovo in posizione orizzontale.

Attenzione

Quando si installa l'impianto di aria condizionata sul tettuccio, bisogna proteggere la parte superiore della cabina con uno straccio o una coperta per evitare eventuali graffi. Per l'installazione del **Compact**, tenere presente che normalmente le cabine munite di oblò dispongono di una struttura abbastanza solida per sostenere il peso dell'impianto. Tuttavia, se così non fosse e se fosse necessario tagliare il tettuccio, o se in presenza di oblò la struttura non fosse abbastanza rigida (se fosse di fibra, plastica, ecc.), è responsabilità dell'installatore decidere se occorre rinforzare il tettuccio per evitare qualsiasi deformazione, rottura o penetrazione d'acqua, ecc., prendendo le misure necessarie per evitarlo.

Attrezzi

Kit di chiavi Torx
 Kit di chiavi Allen
 Chiave fissa 10, 13, 14
 Forbici
 Metro a nastro

Documentazione allegata

Istruzioni di montaggio	1001207466
Guida dell'utente	1001204545
Soluzione dei problemi	1001204543
Garanzia	220AA10017

Simbologia



Fragile



Attenzione alle mani



Tensione elettrica pericolosa

Avvertenze



L'installatore deve essere in possesso della formazione necessaria in materia di aria condizionata per veicoli.



dirna Bergstrom, s.l. declina ogni responsabilità per danni o rotture derivanti dall'errata installazione o dall'errato uso dell'impianto o da sostituzioni o modifiche effettuate senza la necessaria autorizzazione per iscritto.



Impianto precaricato con gas refrigerante, R-134a. (Non manomettere il circuito di gas refrigerante).



Vedi la **procedura di garanzia** del prodotto in **Diagnosi dei problemi**.



Vedi la **Guida dell'utente** dell'impianto per il corretto funzionamento del telecomando e del pannello di controllo.



I seguenti documenti devono essere consegnati all'utente una volta conclusa l'installazione: **Guida dell'utente, Garanzia e Diagnosi dei problemi**.

 Prima di iniziare il montaggio, installare la griglia sull'entrata anteriore dell'aria.



1 Smontare il coperchio dell'oblò, gli elementi di fissaggio e consegnarli al cliente (*).

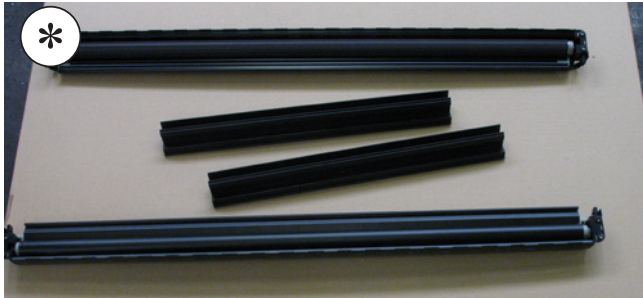

2 Eliminare i residui di adesivo dalla superficie superiore della cabina prima di incollare la guarnizione EPDM.

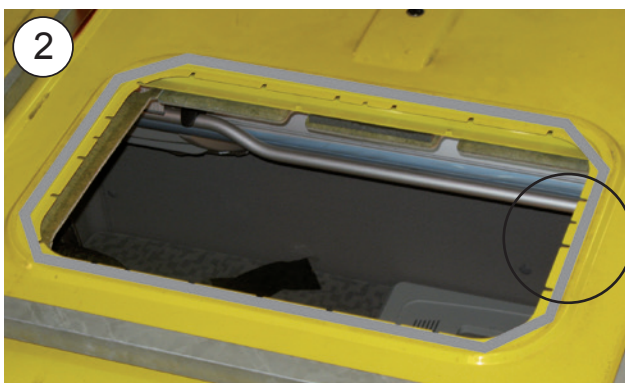
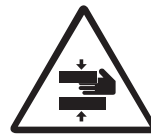

3 Incollare la guarnizione EPDM intorno al foro dell'oblò (vedi particolare per tagliare i bordi).

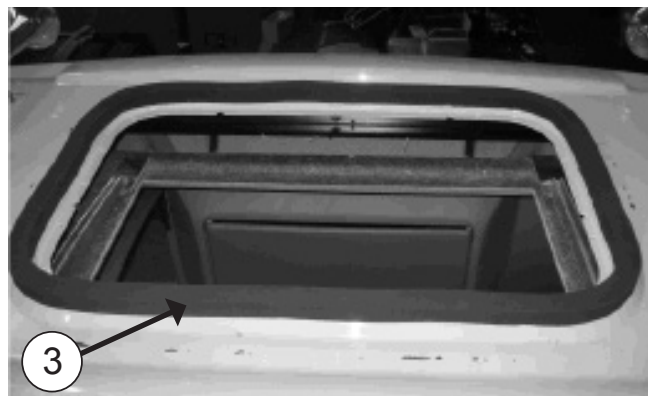

 **COME TAGLIARE LA GUARNIZIONE EPDM PER EVITARE INFILTRAZIONI NELLA CABINA**

A- Incollare la guarnizione mantenendo una protezione di carta di 100 mm su ogni lato.

B- Rimuovere i due pezzi di carta.

C- Incollare premendo su entrambe le estremità.

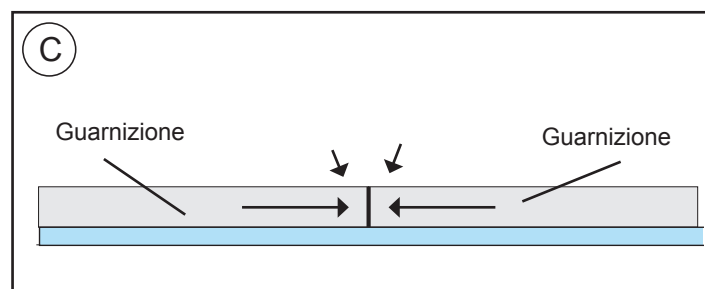
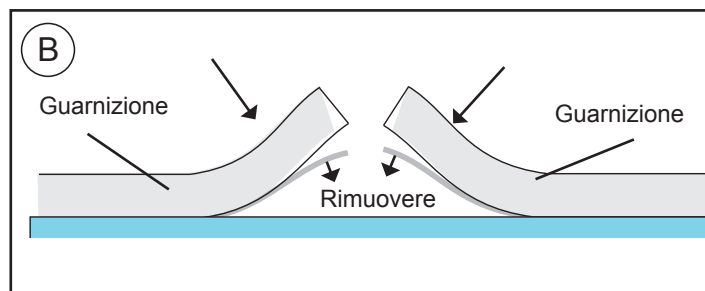
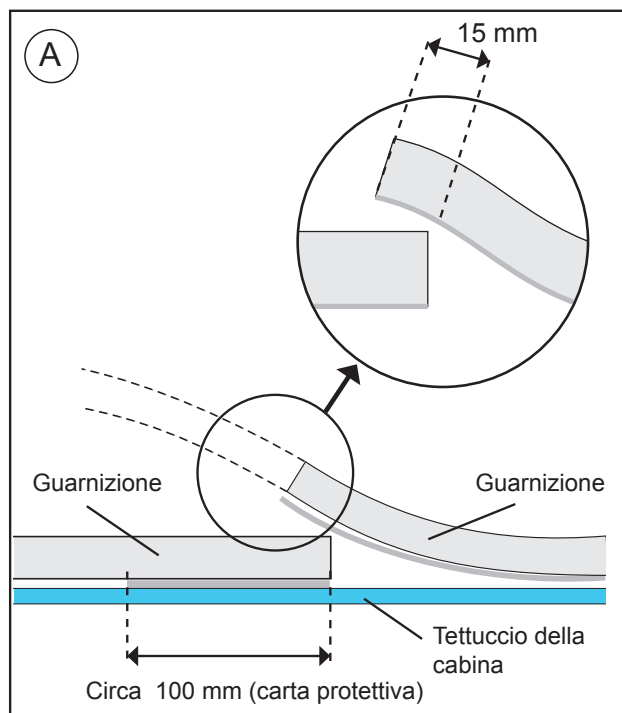

4 **ESTERNO CABINA:**
Inserire il **Compact** nel vano.

Attenzione! Quando si posiziona l'impianto sul vano del tettuccio apribile, controllare che le uscite di scarico non siano ostruite dalla guarnizione EPDM.

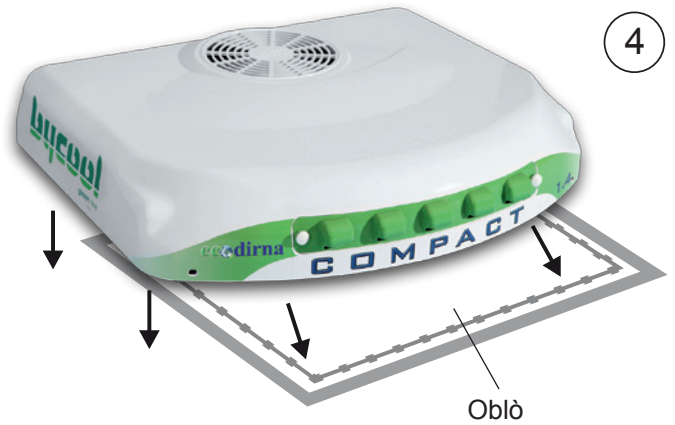

5 Posizionare il canalizzatore di gommapiuma con la parte più morbida sulla base dell'impianto.

Attenzione: A seconda della cabina, può essere necessario usare i (2) canalizzatori in dotazione per la completa adesione del pannello di distribuzione dell'aria ai medesimi.

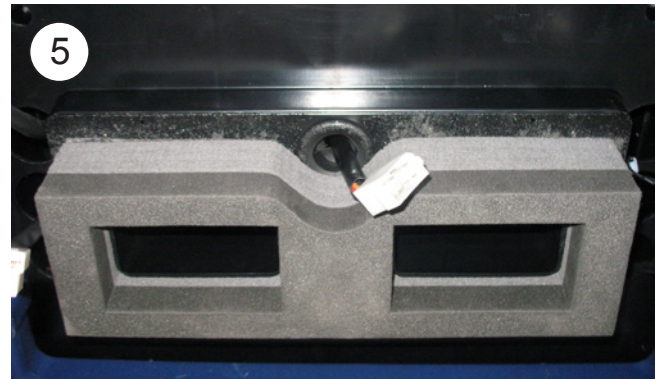

6 **INTERNO CABINA:**
Avvitare di circa 5 mm le (4) viti prigioniera da 8/125x100 o 120 mm, a seconda della distanza (maggiore o minore) dall'impianto finché, posizionando i supporti di fissaggio, le viti non sporgono di 20 mm dagli stessi.

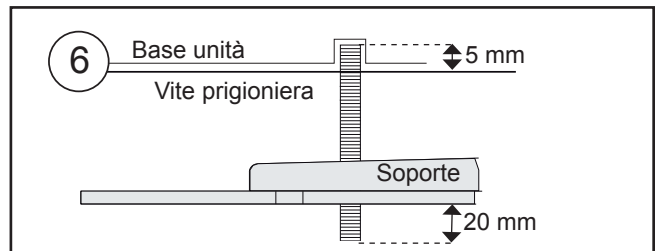

7 Inserire (8) rondella di gomma Ø 7, (1) rondella piana Ø 1 a testa larga, (2) dadi M8 e (1) rondella piana Ø 8 a testa larga, su ciascuna vite prigioniera precedente, seguendo questo ordine.

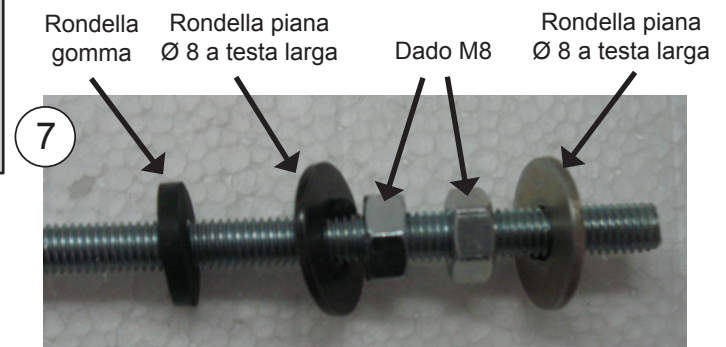

- 8** Fissare i supporti di fissaggio (2), con una rondella (1) e un dado autobloccante (1) M8, senza stringere.

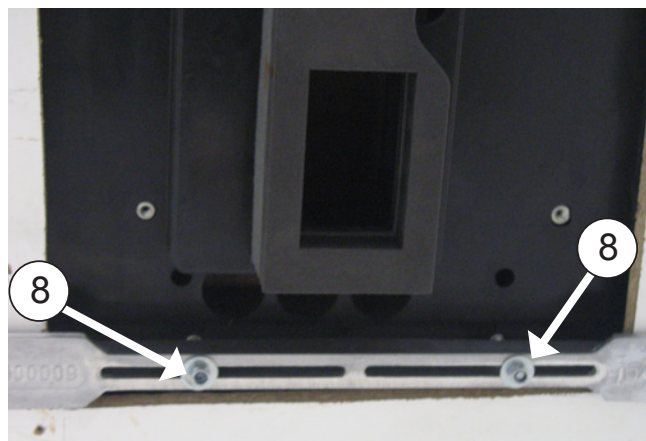
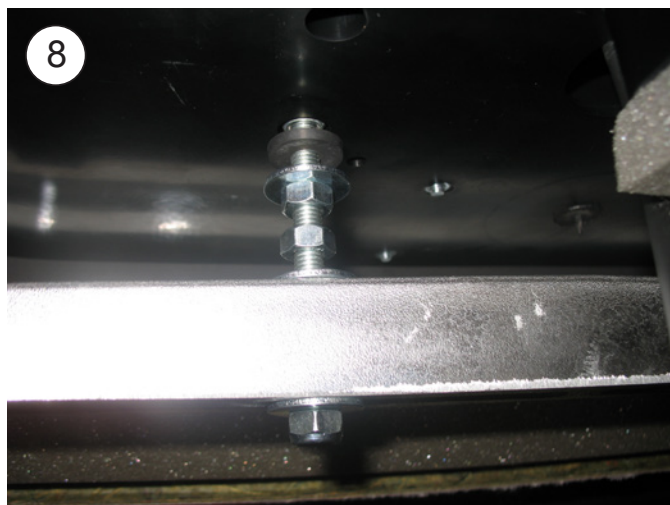

- 9** Avvitare di 10 mm i perni (4) M6 x 80, dove indicato distanza (A) segun nella a figura 16.

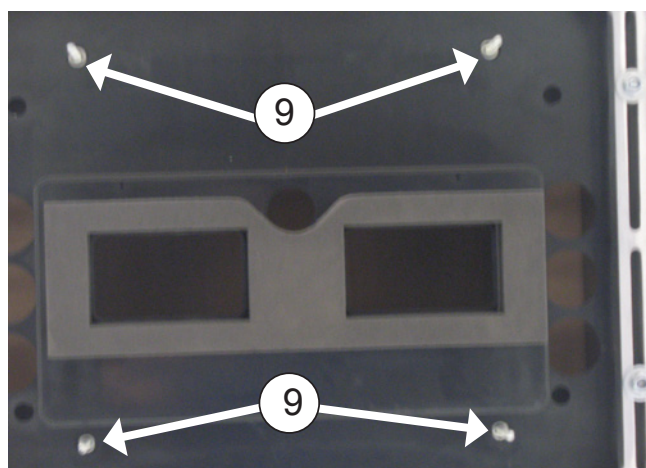
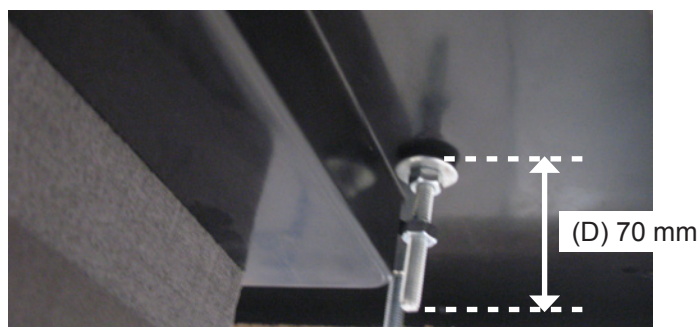

- 10** Inserire (1) rondella Ø 6 di gomma, (1) rondella piana Ø 6 a testa larga e (1) dado M6 su ogni vite prigioniera M6. Quindi stringere il dado fino a premere leggermente la rondella di gomma.

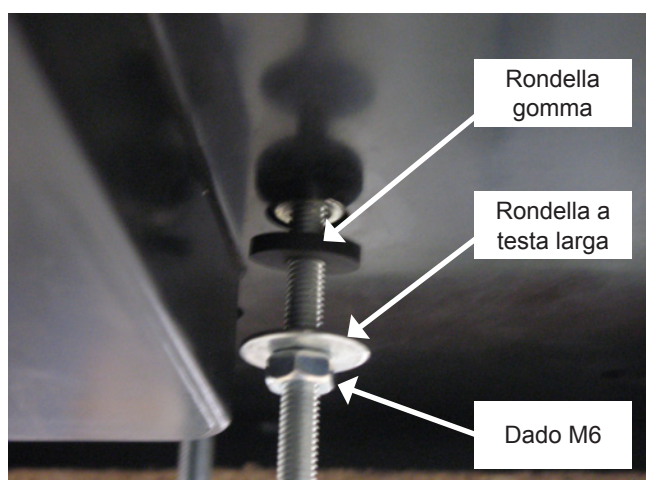

10a

Inserire il dado (1) M6 senza stringere in ogni vite prigioniera.

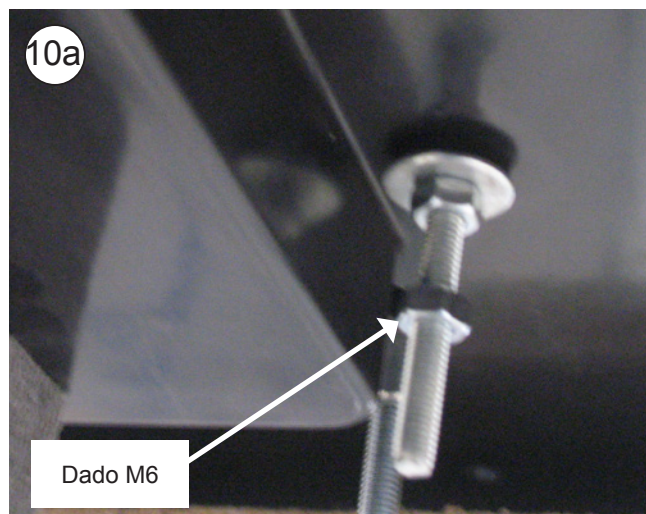

10b

Collegare la scatola a 2 vie del sensore dell'aria di ritorno, la scatola a 4 vie del ventilatore e quella a 8 vie di connessione dei cablaggi del controllo elettronico.

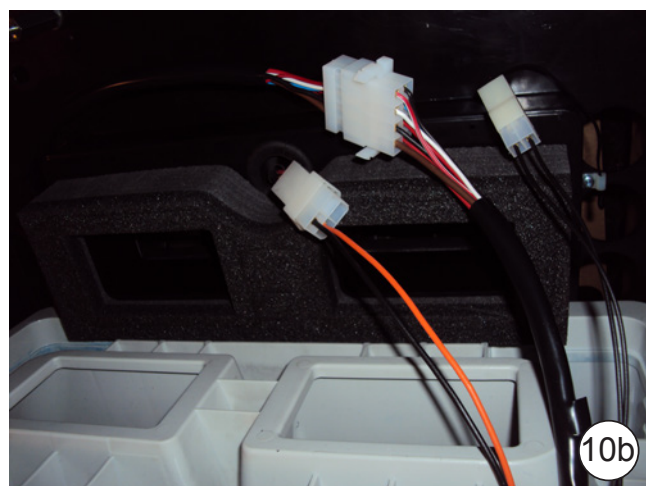

11 Posizionare il pannello interno di distribuzione dell'aria sulle viti prigioniera anteriori con (1) rondella M6 a testa larga e (1) dado M6 su ogni vite prigioniera. Stringere i dadi finché il canalizzatore del pannello interno di distribuzione dell'aria non è a battuta sulla gommapiuma superiore dell'impianto.

Nota bene: il canalizzatore del pannello interno di distribuzione dell'aria deve essere a battuta sulla gommapiuma superiore dell'impianto per evitare perdite d'aria.

Evitare che i cablaggi restino impigliati tra il canalizzatore e la gommapiuma sulla base dell'impianto.

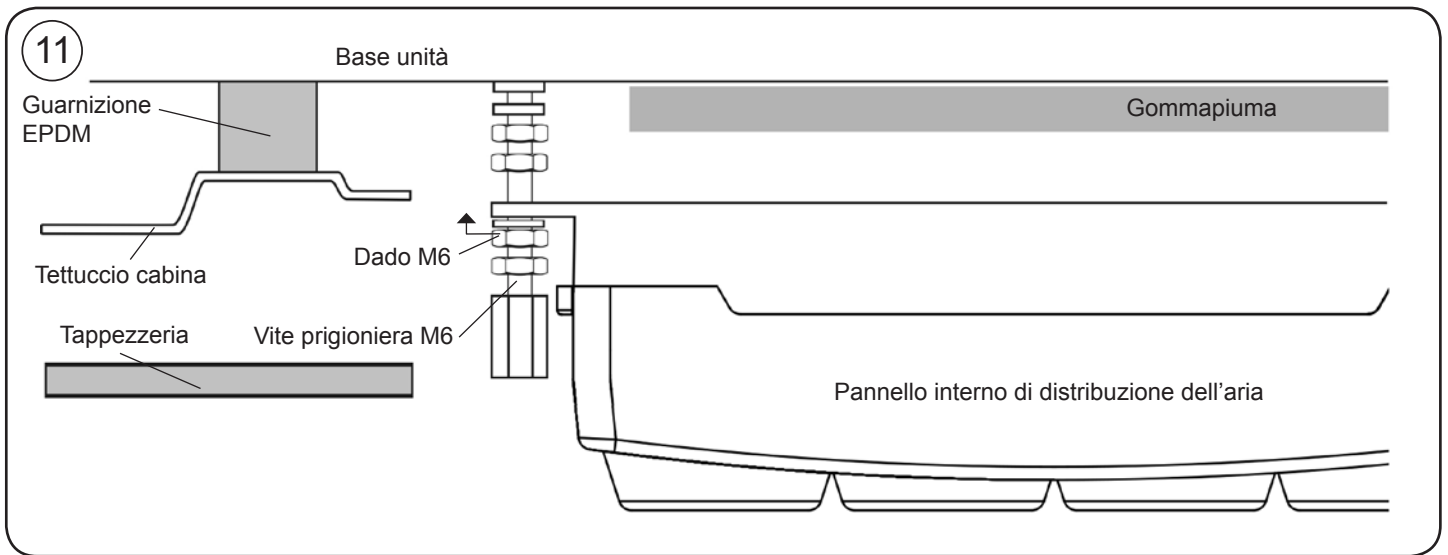

12 Stringere il dado del punto 10a fino a battuta con la parte superiore del pannello interno di distribuzione dell'aria.

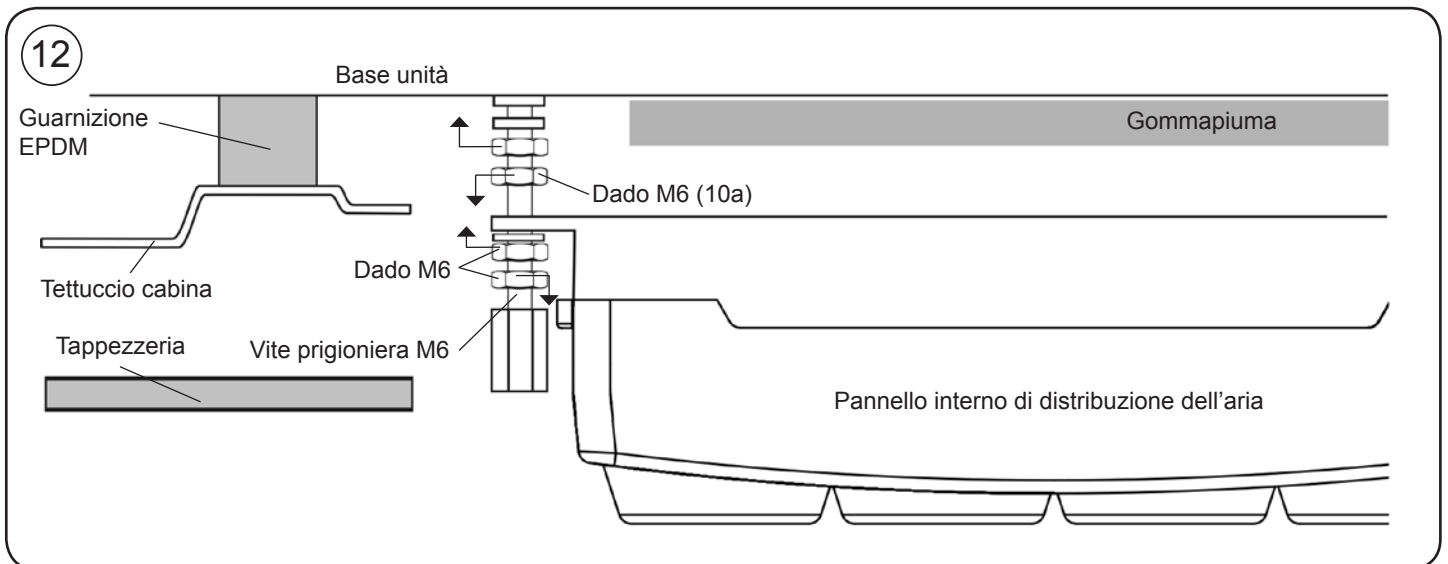

13

Inserire la consolle e centrare l'impianto nella parte più adatta del tettuccio della cabina. Una volta centrato, rimuovere la consolle per la successiva installazione.

14

Fissare i supporti stringendo i dadi fino a comprimere, tra 3 e 6 mm, la guarnizione EPDM (Punto 4) dell'impianto;

Nota bene: Per evitare che infiltrazioni d'acqua nella cabina, verificare il serraggio della guarnizione EPDM con la base Compact base, come illustrato nel Diagramma.

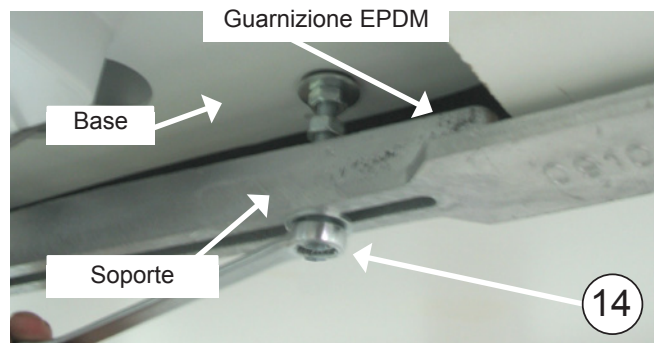
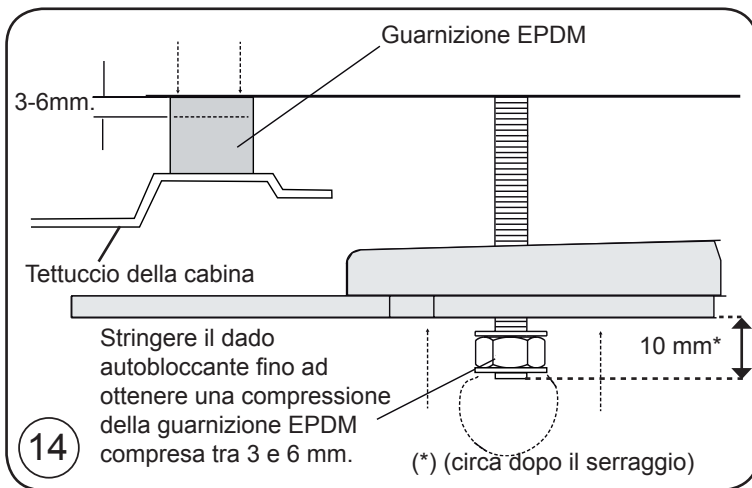

15

Stringere i dadi (4) M8 per fissare a (4) l'unità base.

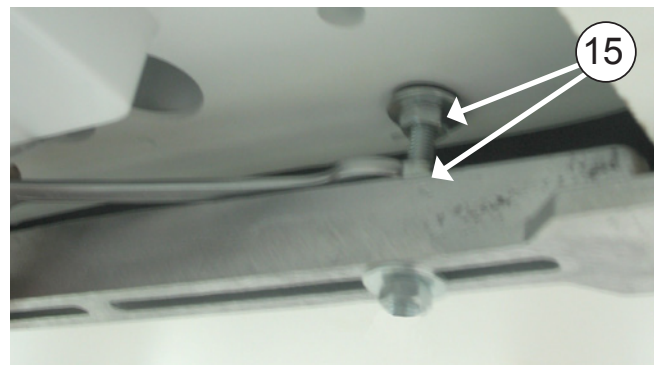

16

Inserire il dado M6 (A) sul dado di fissaggio del pannello interno di distribuzione dell'aria su ogni vite prigioniera. Inserire i perni esagonali M6 e avvitarli fino a lasciarli a 1 mm al di sopra della tappezzeria. Svitare i dadi M6 (A) di questo punto fino a battuta con i perni esagonali e stringerli contro gli stessi.

16

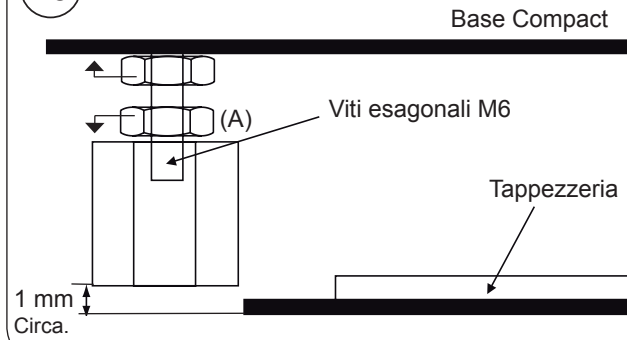

16

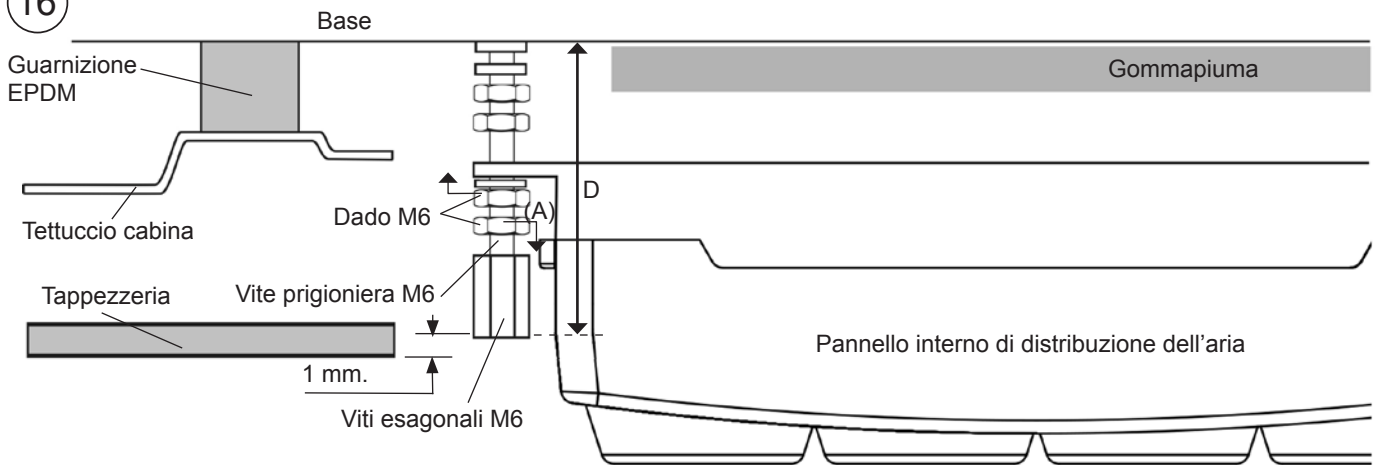

17

Posizionare la consolle usando (4) viti a brugola M6/100x15.



18 Collocare sugli stessi le decorazioni rotonde di plastica M6.



Esploso fino al fissaggio dei supporti di fissaggio

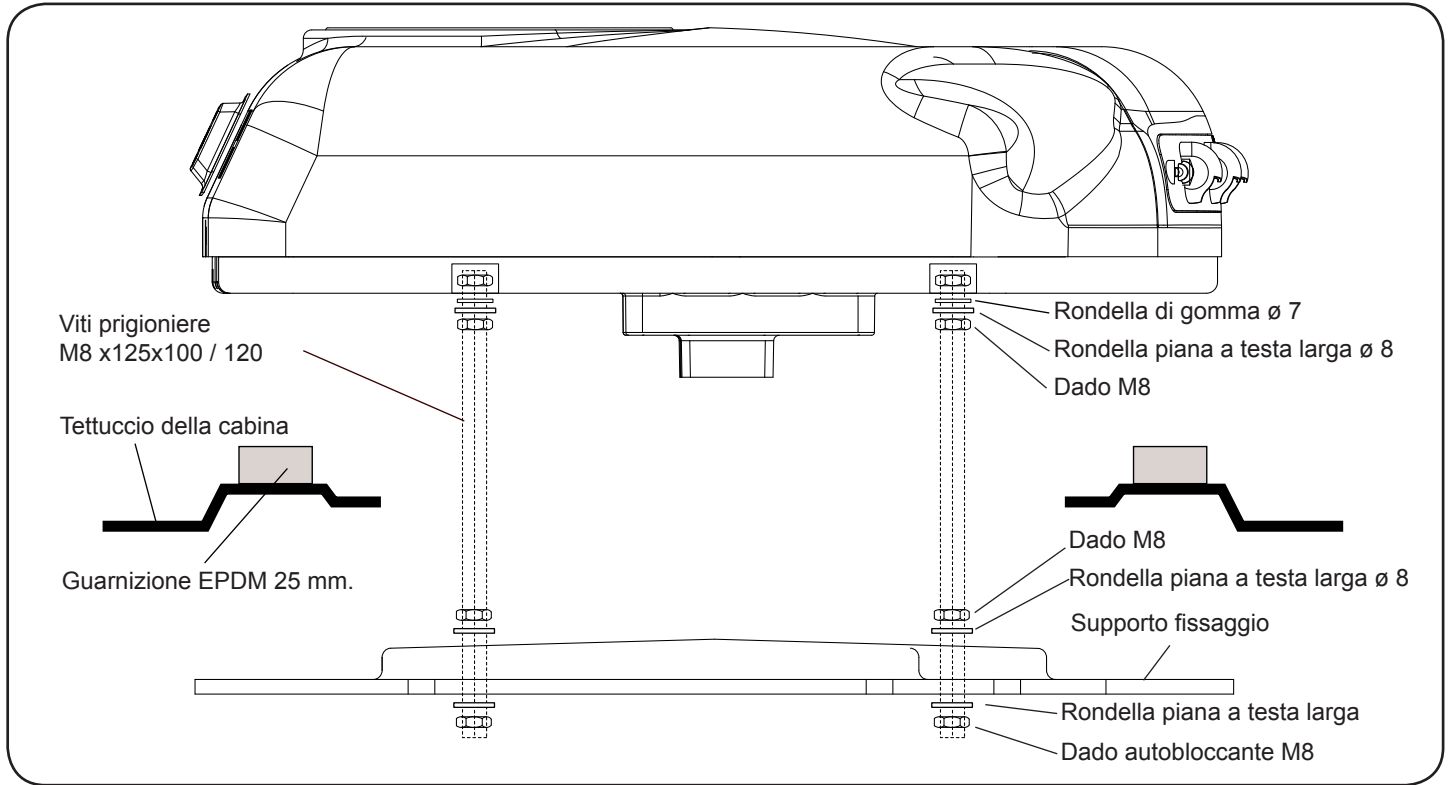

Esploso fino al fissaggio della consolle

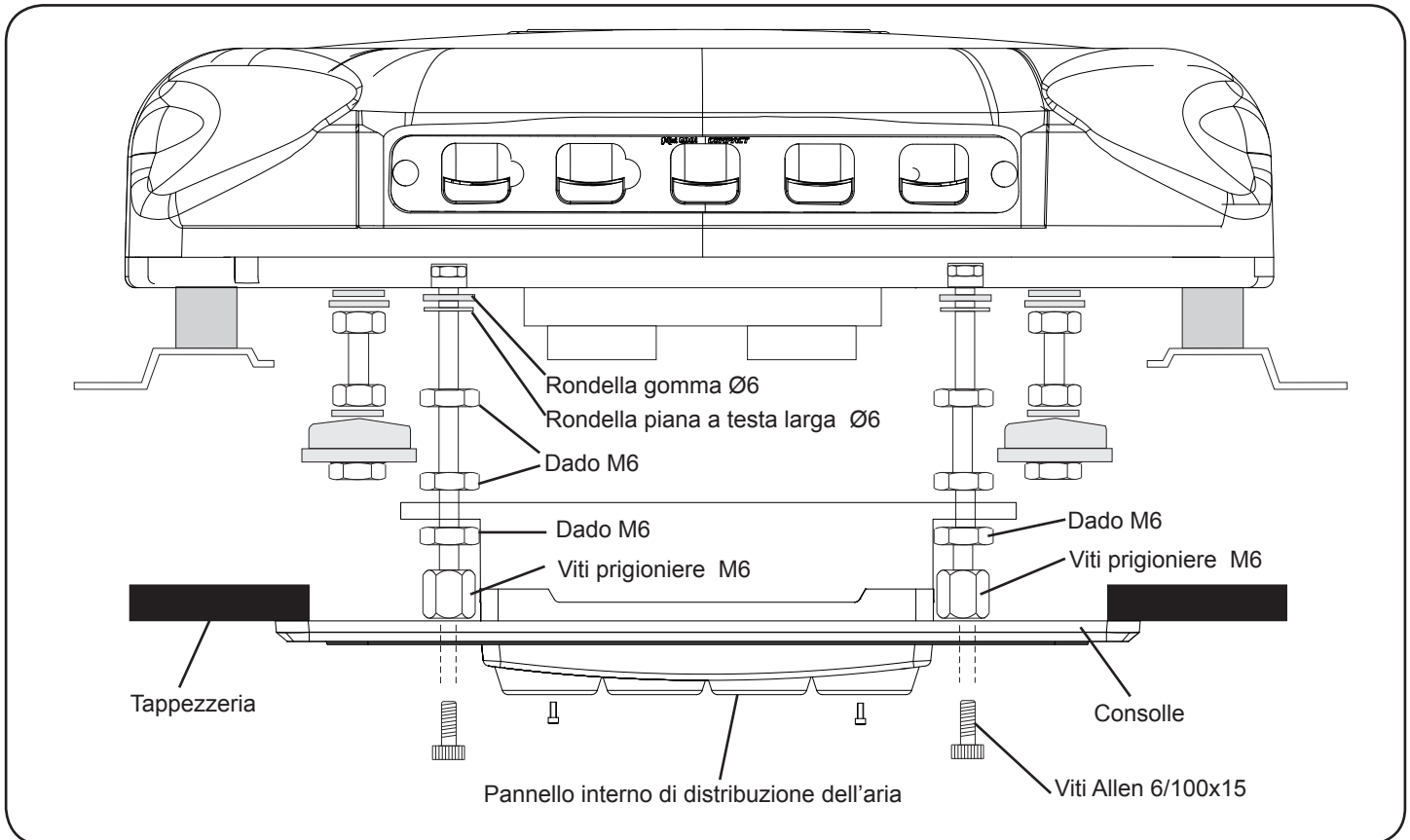

Istruzioni dettagliate Sull'installazione del cablaggio di alimentazione



Cablaggio dell'alimentazione

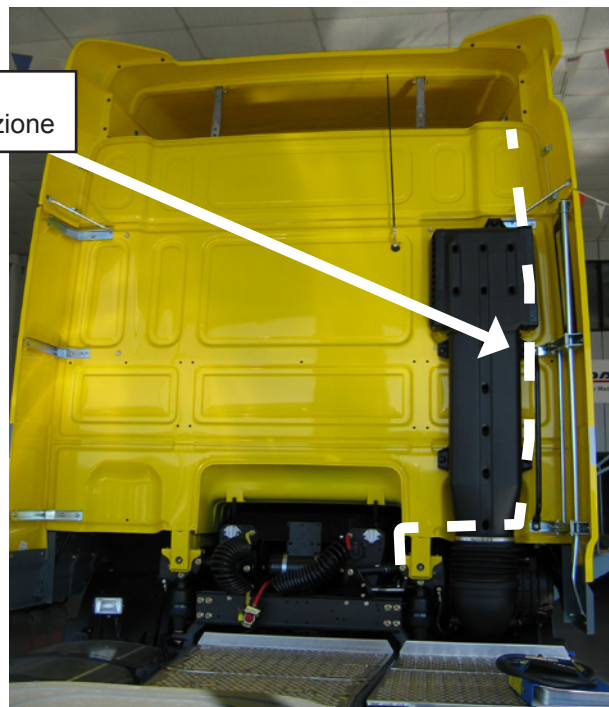

1- Portare il cavo dell'alimentazione dall'apparecchiatura fino alla batteria del veicolo, collocando i supporti in plastica sulla parte posteriore della cabina e fissandoli con flange; dopo con la cabina riversata passare il cavo dalla sua parte inferiore bloccandolo con fascette e viti M4; ma fino alla batteria con flange; si dovrà usare lo stesso passo del cablaggio originale. *(Per collocare i supporti in plastica prima bisogna pulire per bene la zona di adesione)*. Collegando l'apparecchiatura alla batteria si effettuerà un test in tutti i suoi leds, apparirà sul display **88--bd** e si spegnerà.

IMPORTANTE: dovuto al complesso sistema di regolazione elettronica dell'apparecchiatura, la presa di corrente deve essere realizzata direttamente dalla batteria al veicolo, non da qualsiasi altro punto che dia servizio ad altri accessori del veicolo, avendo la precauzione di non invertire la polarità quando si fa il collegamento (2). Se si inverte la polarità il quadro comandi non si accende e l'impianto non funziona.

IMPORTANTE: per la messa in funzionamento si dovrà consultare il Manuale dell'Utente.



Cablaggio elettrico

AVVISO IMPORTANTE!

Fare attenzione a non invertire le polarità quando si esegue il collegamento dell'impianto alla batteria. Infatti, in tal caso il quadro comandi non si accende e l'impianto non funziona.

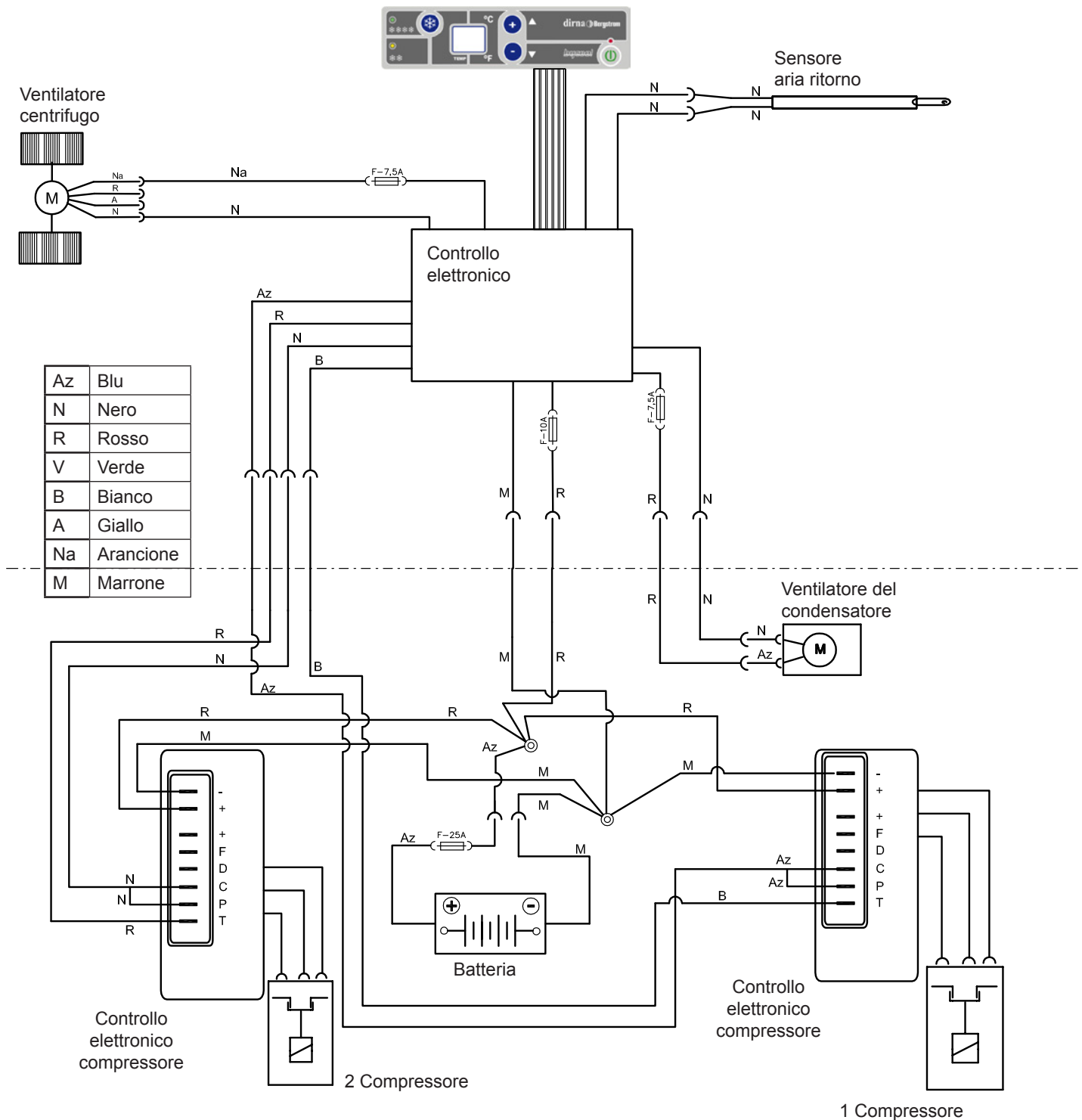

Ed:	21/12/2015
Md:	25/07/2019

b



Francisco Alonso, 6
28806 Alcalá de Henares, Madrid
SPAIN

Contact	Phone	Fax	E-Mail
Sales (Ventas Internacional)	+34 91 8770510	+34 91 8771158	sales@dirna.bergstrominc.com
Comercial Nacional	+34 91 8775841	+34 91 8836321	ventas@dirna.bergstrominc.com
Orders & Deliveries (Logística internacional)	+34 91 8775846	+34 91 8771158	export@dirna.bergstrominc.com
Orders & Deliveries (Logística nacional)	+34 91 8775840	+34 91 8836321	comercial@dirna.bergstrominc.com
Technical Assistance (Internacional)	+49 511 86679681	+49 511 86679710	technicalassistance@dirna.bergstrominc.com
Technical Assistance (Nacional)	+34 91 8775845	+34 91 883 6321	oblanco@dirna.bergstrominc.com

www.dirna.com

	ATENCIÓN:	Dirna Bergstrom se reserva el derecho de efectuar modificaciones en cualquier momento de los datos contenidos en esta publicación, por razones técnicas o comerciales.
	NOTE:	<i>For technical and commercial reasons, Dirna Bergstrom reserves the right to change the data contained in this brochure.</i>
	ATTENTION:	Dirna Bergstrom se réserve le droit d'effectuer à tout moment des modifications des données reprises sur cette publication, pour des raisons techniques ou commerciales.
	HIWEIS:	<i>Dirna Bergstrom behält sich vor, aus technischen oder kaufmännischen Gründen jederzeit Änderungen der Angaben dieser Veröffentlichung vorzunehmen.</i>
	ATTENZIONE:	Dirna Bergstrom si riserva il diritto di effettuare modifiche in qualsiasi momento ai dati contenuti in questa pubblicazione, per motivi tecnici o commerciali.