

**bycool!**  
green line

# COMPACT 1.4 SCANIA



**Instrucciones de Montaje**

*Mounting Instructions*

**Instructions de Montage**

*Montageanweisungen*

**Istruzioni di Montaggio**

**ES** Spanish

**EN** English

**FR** French

**GE** German

**IT** Italian

### Recomendaciones Para el montaje

- Antes de iniciar el montaje leer las instrucciones y seguirlas durante el proceso de instalación.
- Usar las herramientas adecuadas para cada operación.

### Electricidad

- Desconectar la llave de contacto.
- Desconectar la batería antes de empezar el montaje.
- Asegurar el conexionado de los componentes eléctricos, verificando su correcto encaje.

### Atención

Si durante el montaje el equipo se inclina ó se abate la cabina con el equipo montado, se deberá esperar un mínimo de 60 minutos, desde que el equipo quede horizontal, antes de ponerlo en marcha.

### Atención

Al instalar el equipo de aire acondicionado en el techo se debe proteger la parte superior de la cabina con un paño ó manta protectora para evitar posibles arañazos. Al instalar **Compact** en el techo hay que tener en cuenta que, normalmente, las cabinas que vienen provistas de escotilla, tienen una estructura suficiente para soportar el peso del equipo. Sin embargo, cuando no ocurra así y sea necesario realizar corte en el techo ó incluso si en el caso de llevar escotilla el material no es lo suficientemente resistente (caso de techo de fibra, plástico, etc...) es el instalador el que debe decidir, **bajo su responsabilidad**, sobre la necesidad de reforzar el techo para evitar posibles deformaciones, roturas, entradas de agua, etc... habilitando los medios para que esto no ocurra.

### Herramientas

- Juego de Llaves Torx
- Juego de Llaves Allen
- Llave fija 10, 13, 14
- Tijeras
- Flexómetro

### Documentación incluida

Instrucciones de montaje	1001207463
Manual del usuario	1001204545
Diagnóstico de averías	1001204543
Garantía	220AA10017

### Simbología



Frágil







Atención corte!



Riesgo eléctrico

### Advertencias

-  El personal instalador debe poseer una formación suficiente en Aire Acondicionado de vehículos.
-  **dirna Bergstrom, s.l.** queda exenta de responsabilidad si se producen averías que procedan de una inadecuada manipulación ó instalación del equipo, o por modificaciones y sustituciones efectuadas sin nuestra expresa autorización por escrito.
-  **Equipo precargado con gas** refrigerante R-134a. **(No manipular el circuito de gas refrigerante).**
-  Véase **procedimiento de garantía** del producto incluido en **Diagnóstico de Averías.**
-  Véase **Manual de Usuario** del equipo para el correcto funcionamiento del mando a distancia y del panel de control.
-  Al finalizar la instalación se debe entregar al usuario: **Manual del Usuario, Garantía y Diagnóstico de averías.**

 Antes de empezar con el montaje, montar rejilla entrada aire delantera.



**1** Desmontar tapa escotilla, los elementos de fijación y entregar éstos al cliente.



**2** **EXTERIOR CABINA:**  
Posicionar el Compact en el hueco de la escotilla sobre cubrecantos original.  
**Atención!!!** Al colocar el equipo encima del hueco escotilla, revisar que las salidas de desagüe no queden obstruidas.

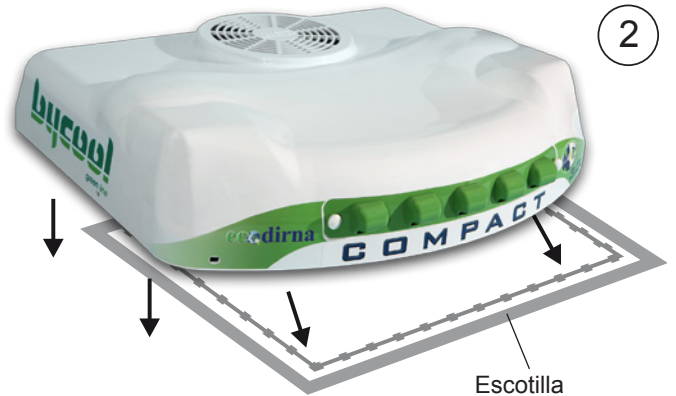

**3** Colocar canalizador gomaespuma quedando la parte más blanda en la base del equipo.  
**Atención:** Dependiendo de la cabina, es posible que sea necesario usar los (2) canalizadores suministrados para que el panel de distribución de aire quede totalmente ajustado con ellos.



**4 INTERIOR CABINA:**

Roscar 5 mm aproximadamente (4) espárragos 8/125x100-140, la medida se elegirá tras presentar los soportes de sujeción y teniendo en cuenta que los espárragos deben sobresalir de los mismos por la parte inferior unos 20 mm.

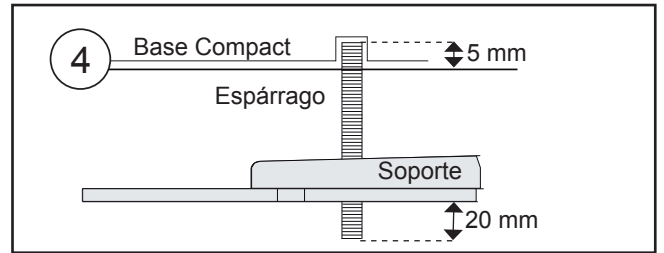

**5** Colocar (1) arandela Ø 7 de goma, (1) arandela plana Ø 8 ala ancha, (2) tuerca M8 y (1) arandela plana Ø 8 ala ancha , en cada uno de los espárragos anteriores; siguiendo dicho orden.

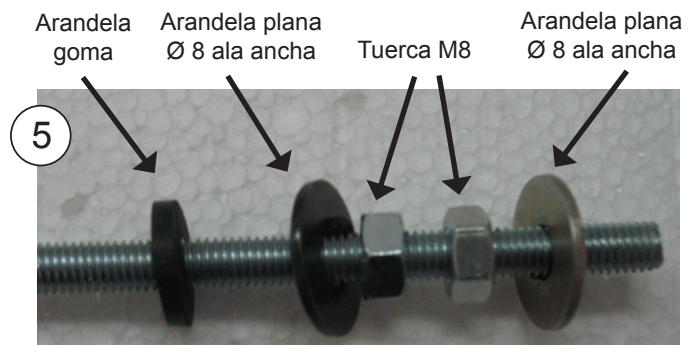

**6** Colocar (2) soportes sujeción, con (1) arandela y (1) tuerca autoblocante M8, **sin llegar a apretar.**

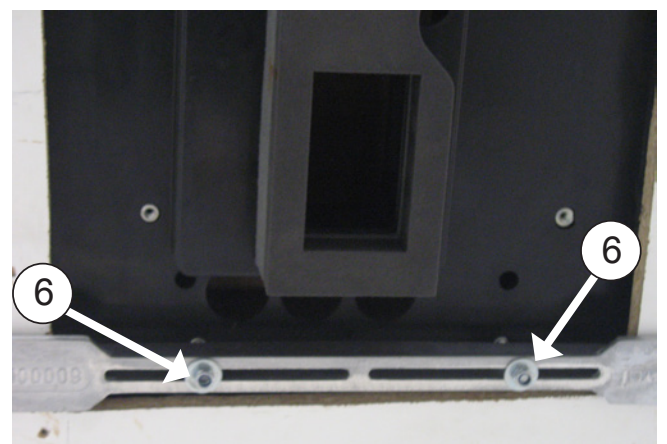
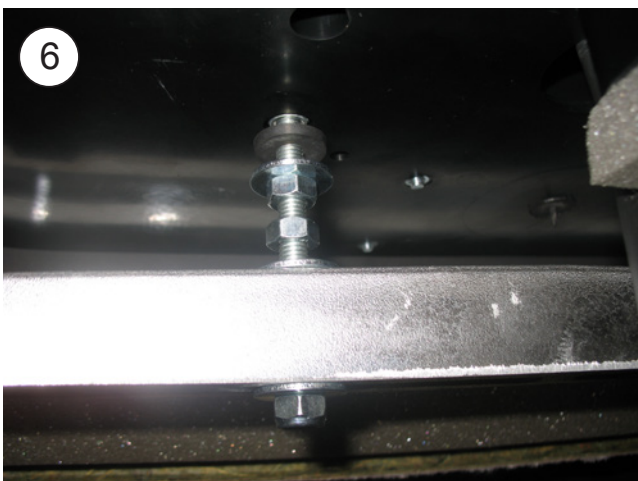

**7** Roscar 10 mm (4) espárragos M6, donde se indica, según distancia (A) del esquema del punto 11.

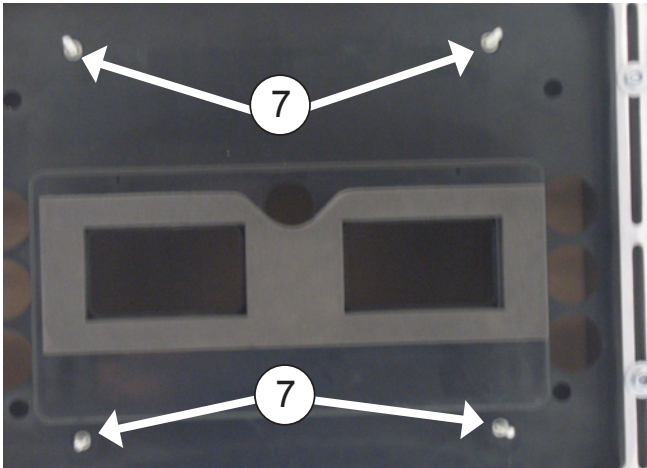
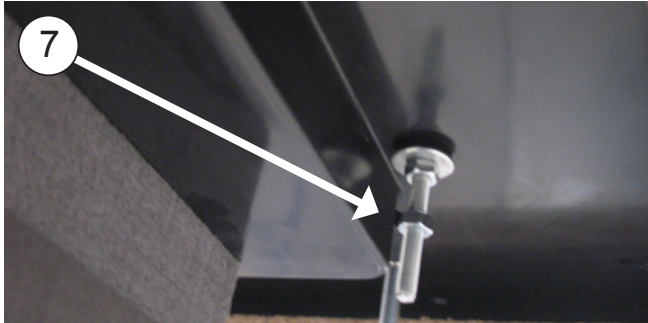

**8** Colocar (1) arandela Ø6 de goma, (1) arandela plana Ø6 ala ancha y (1) tuerca M6, sobre cada uno de los espárragos de M6. A continuación apretar la tuerca hasta que la arandela de goma quede un poco oprimida.

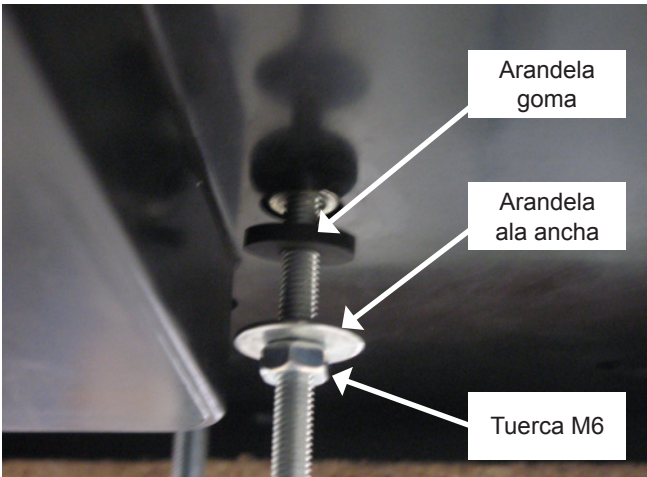

**9** Colocar (1) tuerca M6 sin apretar en cada espárrago.

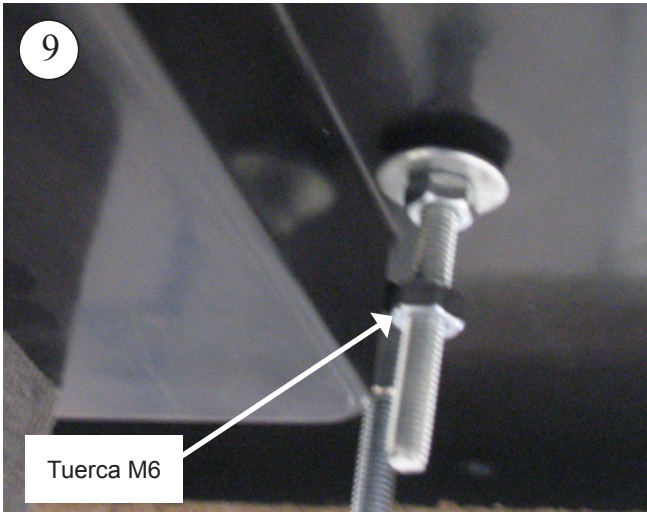

**10** Conectar la caja de 2 vías del sensor del aire de retorno, la caja de 4 vías del soplador y la de 8 vías de conexión de los cableados del control electrónico.

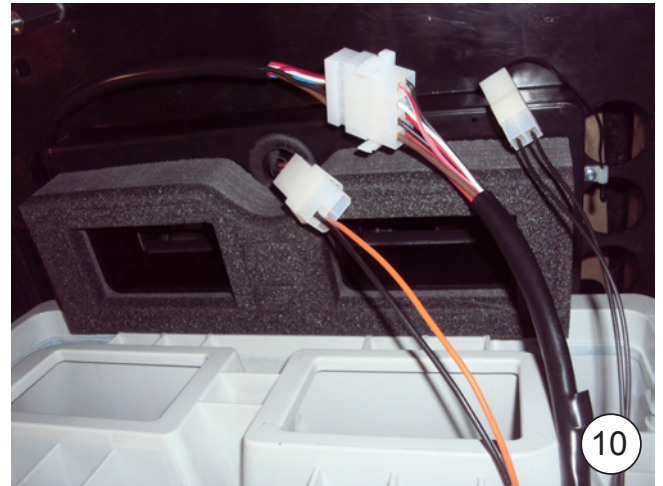

**11** Colocar panel interior de distribución de aire en los espárragos anteriores con (1) arandela M6 ala ancha y (1) tuerca M6 en cada espárrago. Apretar tuercas hasta que el canalizador del panel interior de distribución de aire haga tope en goma espuma superior del equipo.

**Importante: El canalizador del panel interior de distribución de aire debe hacer tope contra la goma espuma superior para evitar fugas de aire.**

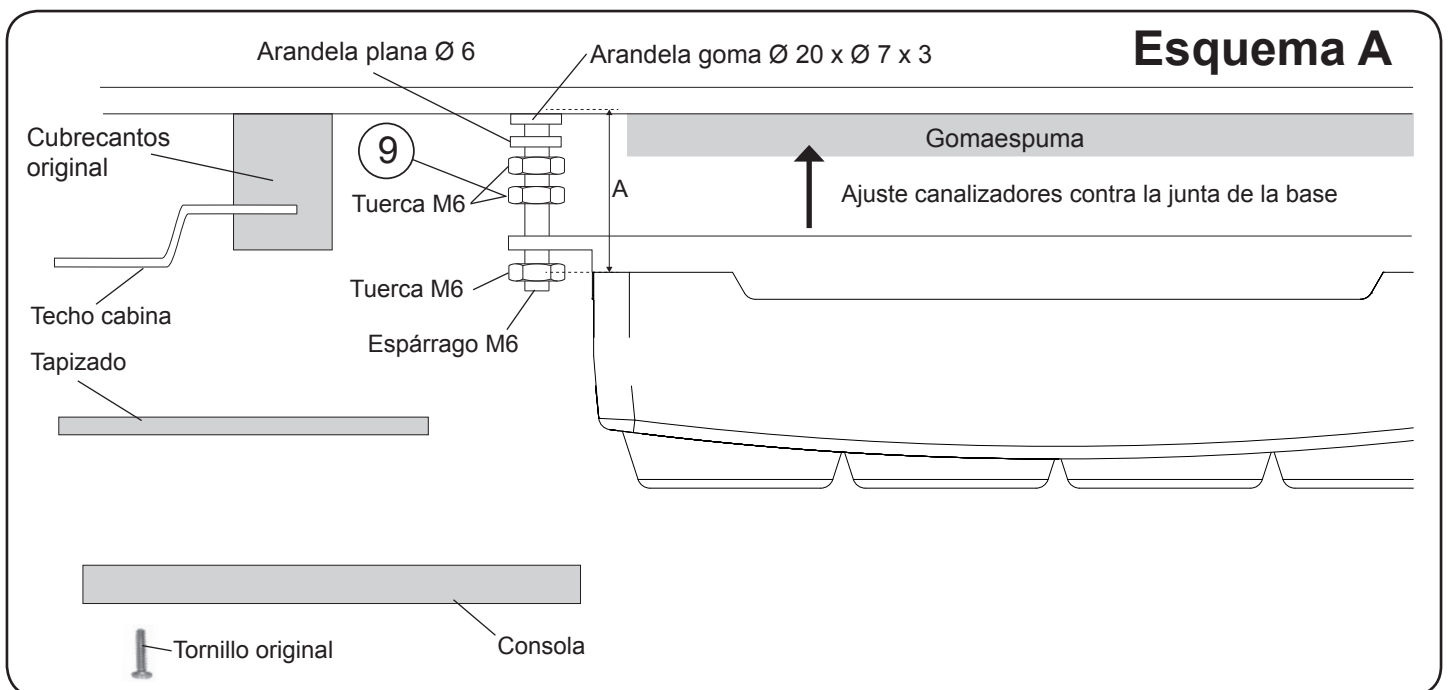

**12** Apretar tuerca del punto **9** hasta hacer tope con la parte superior del panel interior de distribución de aire.

**13** Presentar la consola y centrar el equipo hasta hacer coincidir los tornillos originales en su posición original.



**14** Una vez realizadas estas operaciones desmontar la consola para fijar los soportes, apretando tuercas A hasta el apriete del cubrecantos original con la base del equipo, después apretar las tuercas B y C. (ver esquema).

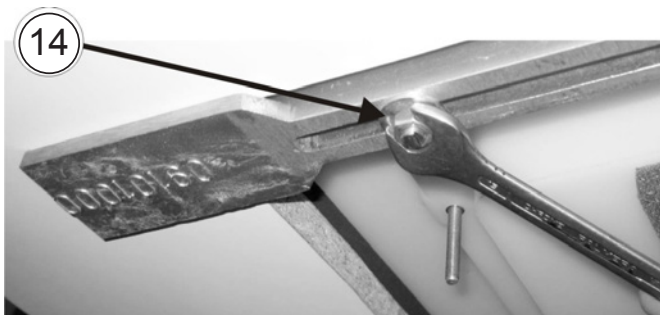
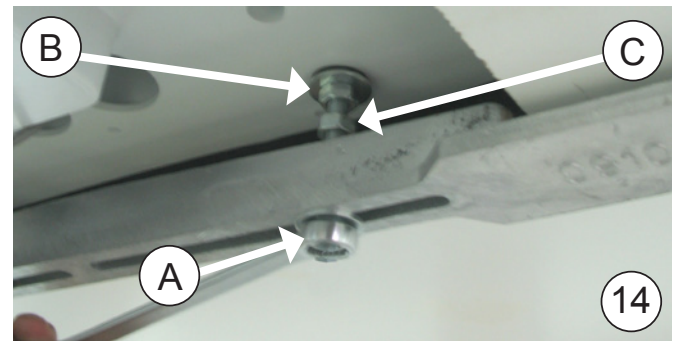

15

**Importante:**

Para evitar posibles filtraciones de agua, asegurar el apriete del cubrecantos original con la base del equipo tal como se indica en el esquema.

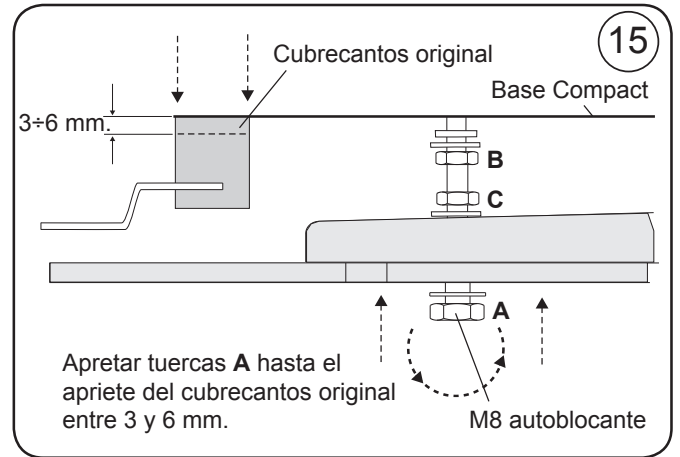

16

Colocar consola con (4) allen 6/100x15 en tuercas originales y poner 8 tapones de plástico.





Vista explosionada hasta la fijación de los soportes

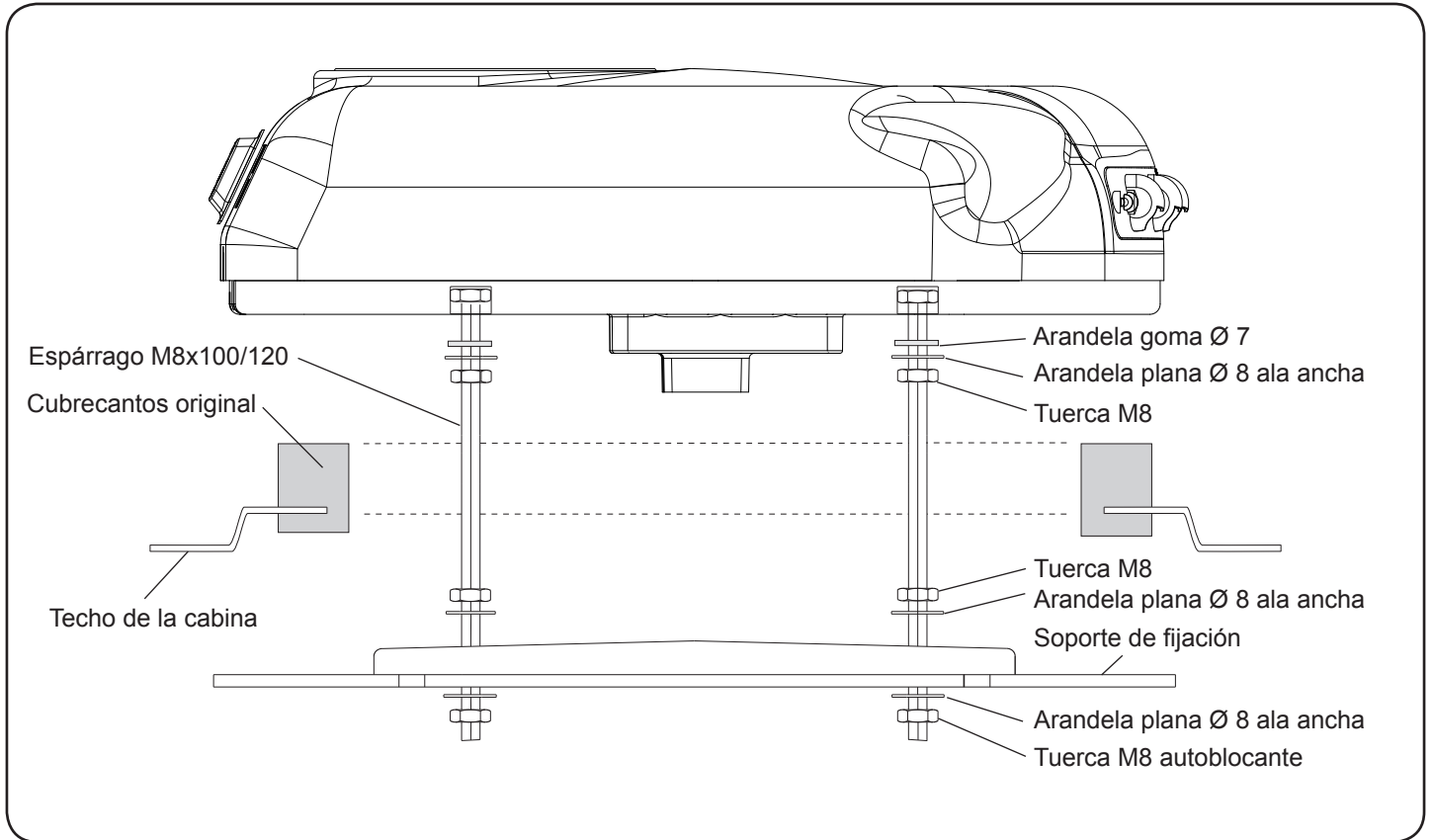

Vista explosionada hasta la fijación de las consolas

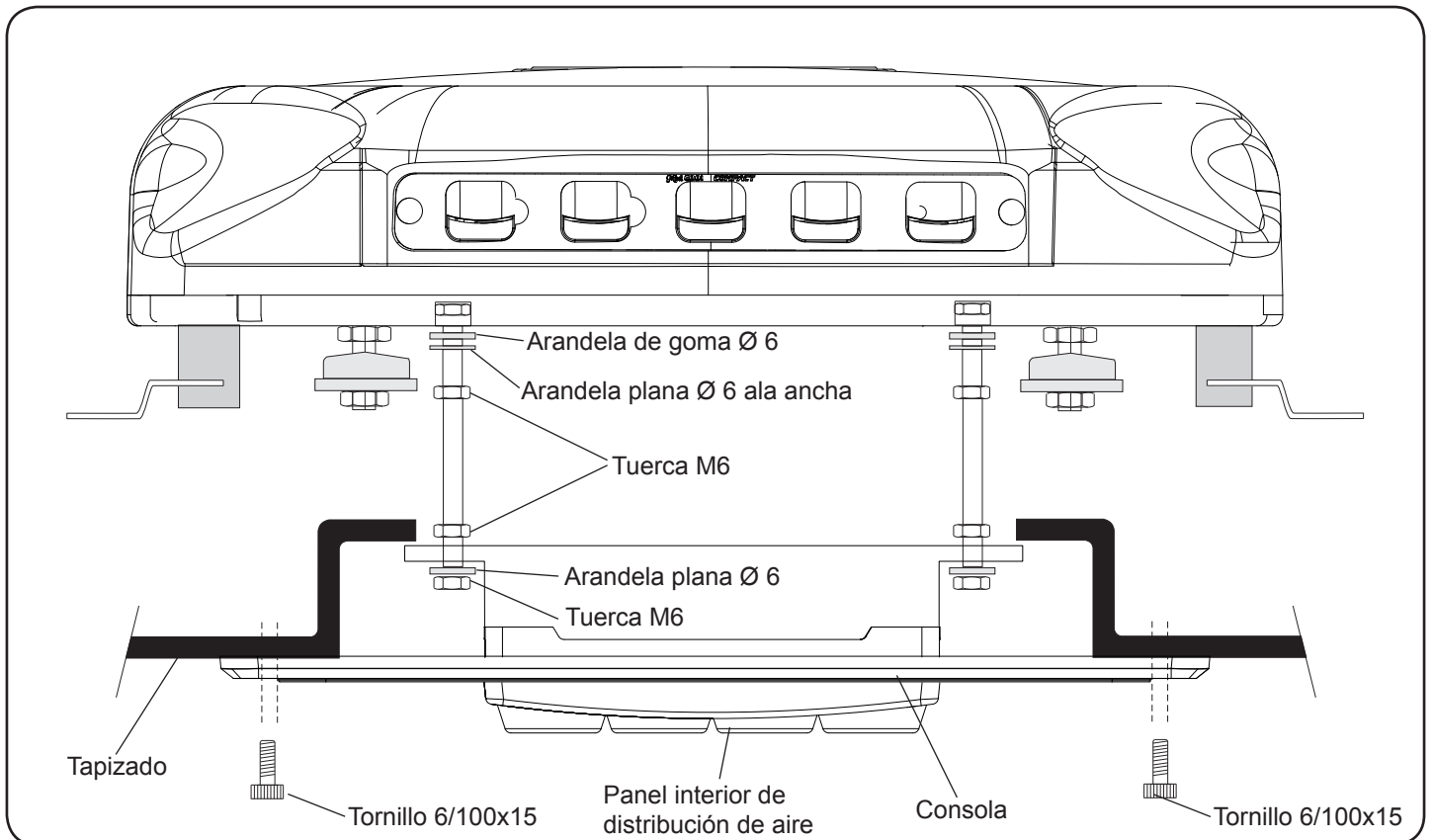

Instrucciones detalladas  
sobre la instalación del cableado de alimentación



1- Llevar el cable de alimentación del equipo hasta la batería del vehículo, pegando los soportes de plástico en la parte posterior de la cabina y fijándolo con bridas; después con la cabina abatida pasar el cable por la parte inferior de la misma sujetándolo con abrazaderas y tornillos M4; y hasta la batería con bridas; se debe utilizar el mismo paso del cableado original. (Para pegar los soportes de plástico limpiar bien la zona antes). Al conectar el equipo a la batería éste hará un test en todos sus leds, aparecerá en el display 88-bd y se apagará.

**Importante:** Debido al complejo sistema de regulación electrónica del equipo la toma de corriente debe realizarse directamente a la batería del vehículo, no a cualquier otro punto que dé servicio a otros accesorios del vehículo teniendo la precaución de no invertir la polaridad al realizar la conexión. Si se invierte la polaridad la placa de mandos no se enciende y el equipo no funciona.

**Importante:** Para la puesta en marcha consultar el Manual del Usuario.

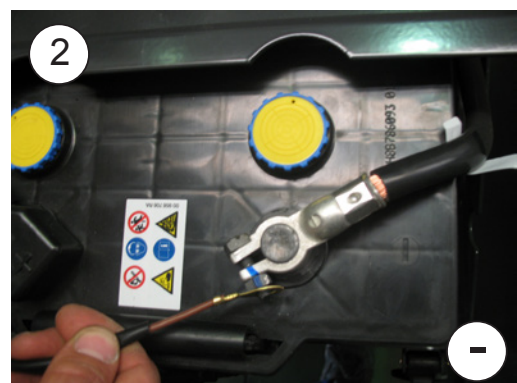
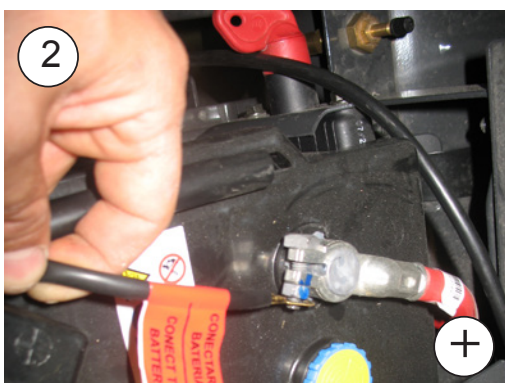

Esquema eléctrico

¡AVISO IMPORTANTE!

**Precaución** de no invertir las polaridades al conectar el equipo a la batería. Si esto sucediera, la placa de mandos no se enciende y el equipo no funciona.

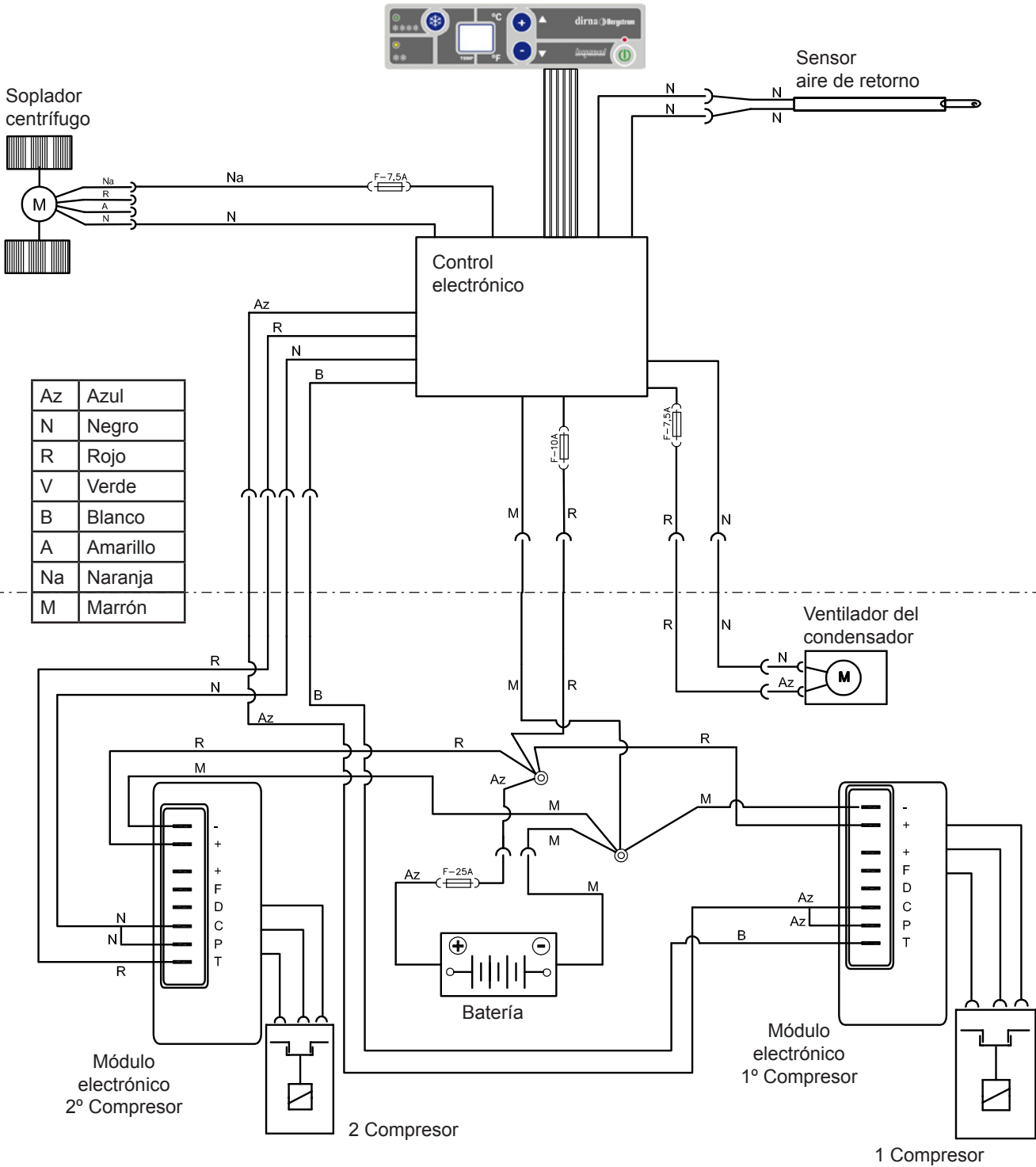

**Assembly Recommendations**

- Before starting assembly, please read instructions and follow them during installation process.
- Use the adequate tools for each operation.

**Electricity**

- Disconnect ignition key.
- Disconnect battery before starting assembly.
- Make sure electric components are securely connected, checking their correct fitting.

**Warning**

If the unit slants during assembly, wait for at least 60 minutes with the unit in horizontal position before starting it up.

**Warning**

When installing air conditioning equipment on roof, the upper cabin part must be protected with a cloth or a protective blanket to avoid possible scratches. When installing **Compact** on roof, take into account that, normally, cabins equipped with a hatch have a strong enough structure to hold equipment weight. However, if it is not the case and it is necessary to carry out a cut in the roof or, although it has a hatch, the material is not resistant enough (*if roof is made of fibre, plastic, etc...*), it is the installer who will have to decide, under his responsibility, if it is necessary to reinforce the roof to avoid possible deformations, breaks, water entries, etc., habilitating the means required to stop it from occurring.



**Tools**

- Torx wrenches set
- Allen wrenches set
- Open-jawed spanner 10, 13, 14
- Scissors
- Flexo-meter







**Documentation included**

Mounting instructions	1001207463
User's guide	1001204545
Troubleshooting	1001204543
Warranty	220AA10017

**Symbology**

-  Fragile
-  Beware of cuts!
-  Electrical hazard

**Warnings**

-  The installing personnel must have a sufficient training in vehicles air conditioning.
-  **dirna Bergstrom, s.l.** shall not be responsible for breakdowns or damages coming from an inadequate handling or installation of the equipment or from modifications and substitutions carried out without our express and written authorisation.
-  **Equipment pre-charged with refrigerating gas, R-134a. (Do not handle refrigerating gas circuit).**
-  Please see product **warranty procedure** included in **Troubleshooting**.
-  Please see equipment **User's Guide** for its correct functioning of the remote control and control panel.
-  Once installation is finished, the following documents must be handed over to the user: **User's Guide, Warranty and Troubleshooting**.

 Mount the front air input grille before starting assembly.



**1** Dismantle sun hatch, fastening elements and hand over to client.



**2** **OUTSIDE CABIN:**  
Position the Compact in the hatch gap on the original edgeband.  
**Caution! When positioning the unit above the hatch gap, check that the wastewater run-offs are not blocked.**

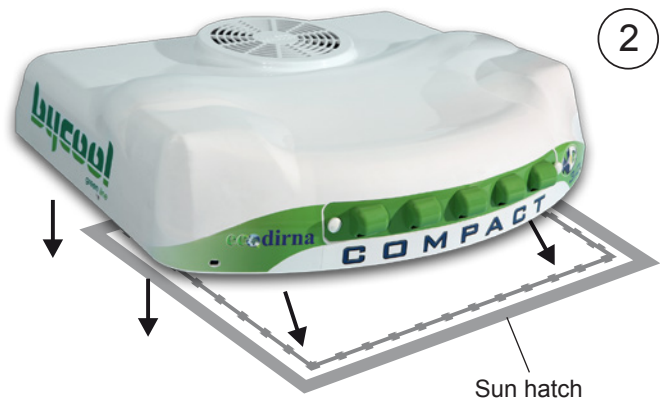

**3** Position the foam rubber, ensuring the softest part is placed on the base of the unit.  
**Caution:** Depending on the cabin, it may be necessary to use the (2) supplied ducts in order for the distribution panel to be completely adjusted.



**4** **INSIDE CABIN:**  
Screw about 5 mm (4) 8/125x100-140 mm studs, the exact measure is chosen after the fastening supports have been presented and taking into account that studs must stick out of lower part about 20 mm.

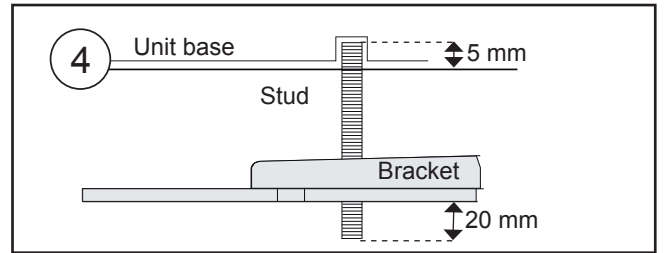

**5** Following this order:  
- plane rubber wash  
- plane rubber wash wide wing diameter 8  
- nut M8  
- plane washer diameter 8 wide wing

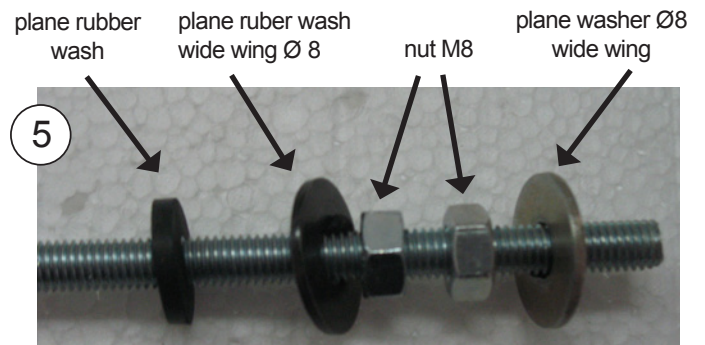

**6** Place (2) fastening supports, with (1) washer and (1) M8 self-blocking nut, **without tightening.**

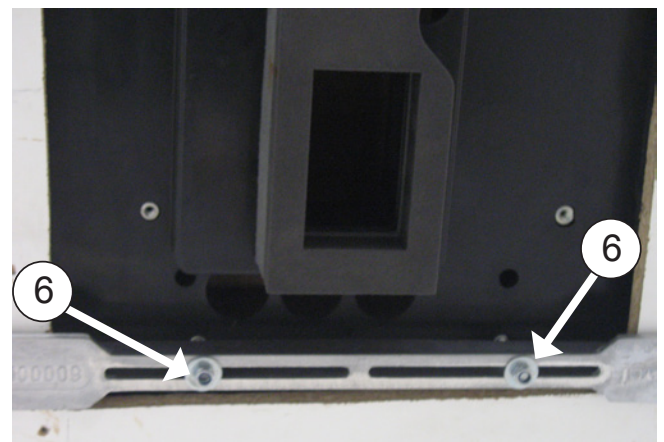
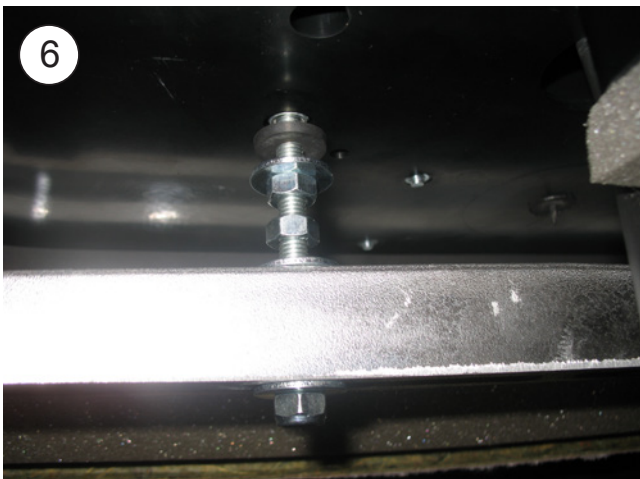

**7** Screw 10 mm deep (4) M6 studs, where indicated distance (A) in figure point 11.

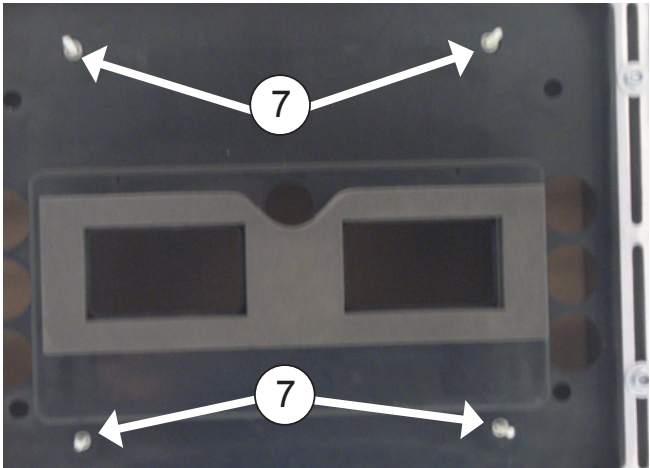
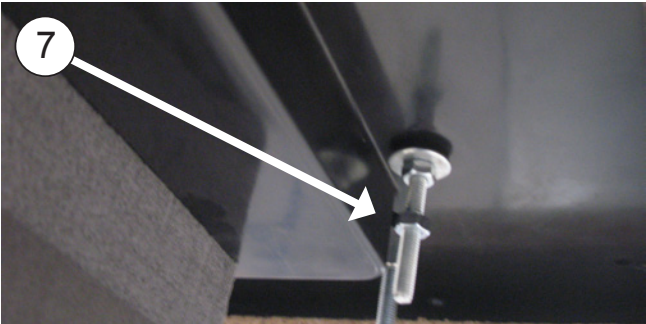

**8** To place (1) rubber washer diameter 6 (1), plane washer diameter 6 wide wing and (1) nut M6, over each of the spigots of M6. After, to tight the nut til the rubber washer remain a little tight.

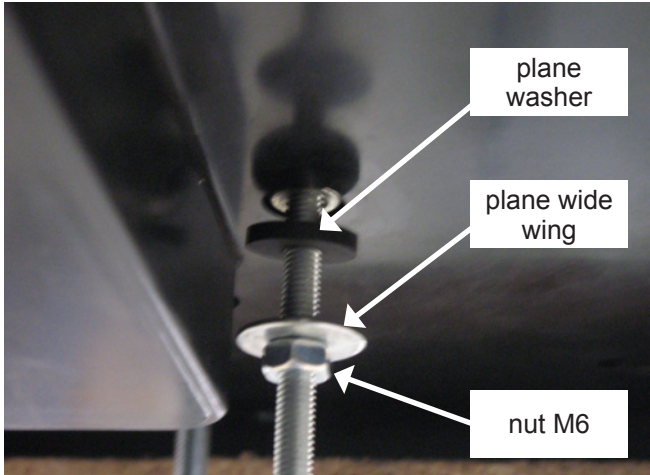

**9** Place (2) fastening supports, with (1) washer and (1) M6 nut, **without tightening**.

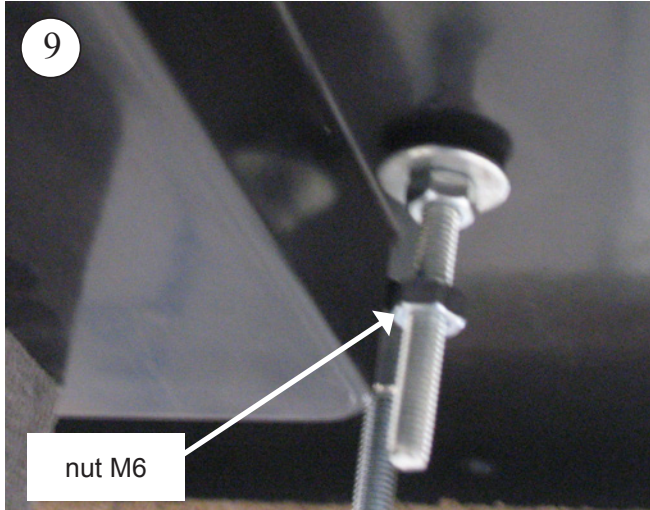

**10** Connect the return air sensor 2-way box, the blower 4-way box and the electronic control cable connection 8-way box.

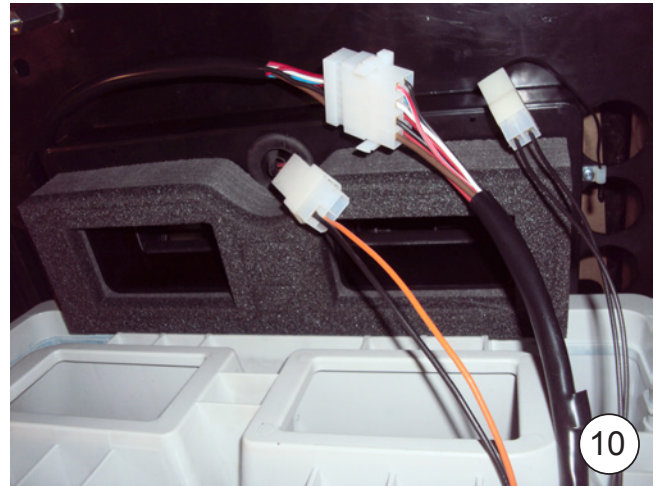

**11** Position the interior air distribution panel on the front studs with (1) M6 wide-rimmed washer and (1) M6 nut on each stud. Tighten the nuts until the interior air distribution panel duct comes up against the unit's top foam.

**Important:** The interior air distribution panel duct must come up against the unit's upper foam in order to prevent any leakages of air.

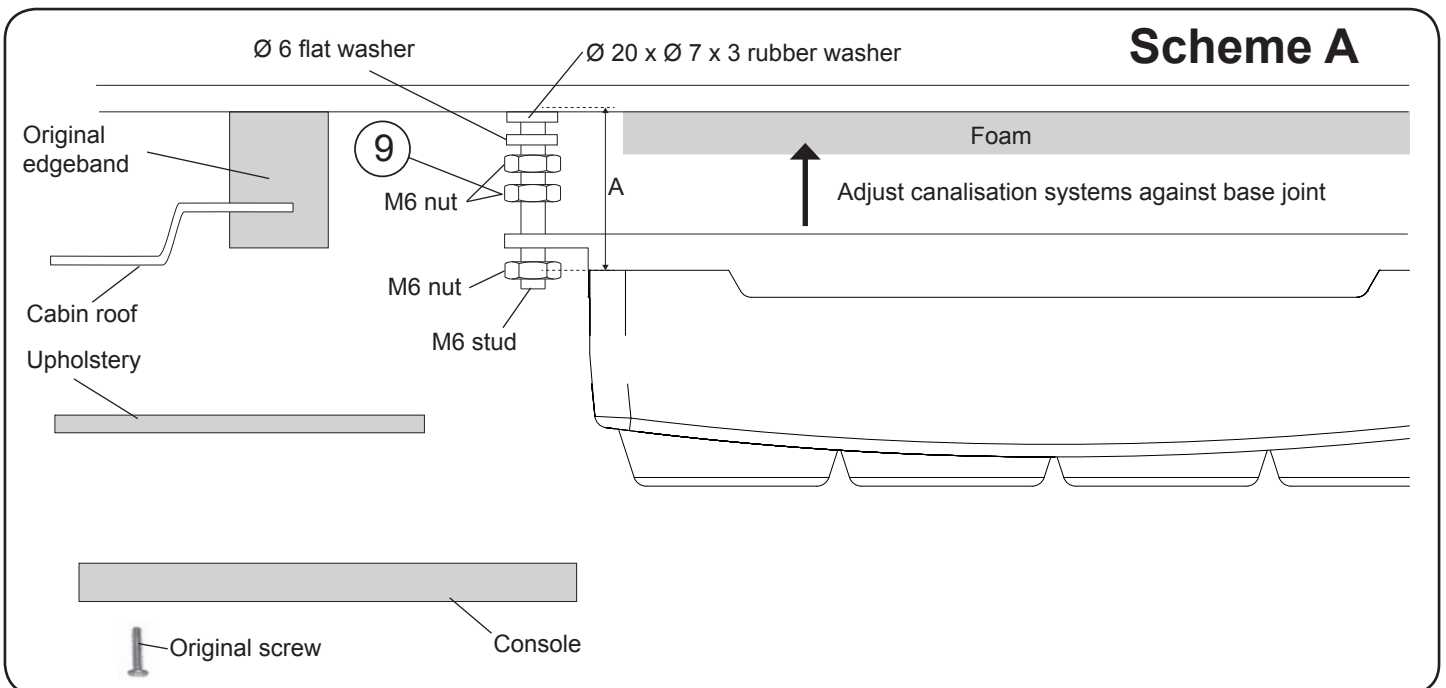



**12** Tighten the nut in point **9** until it comes up against the top part of the interior air distribution panel.

**13** Present console and centre Compact until original screws coincide with their original position.



**14** Once these operations have been carried out, take down the console in order to secure the supports by tightening the nuts (A) until the original edgeband is tight against the base of the unit, then tighten nuts (B) and (C) (see diagram).

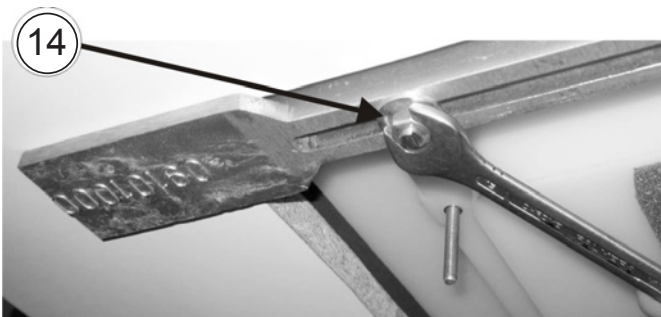
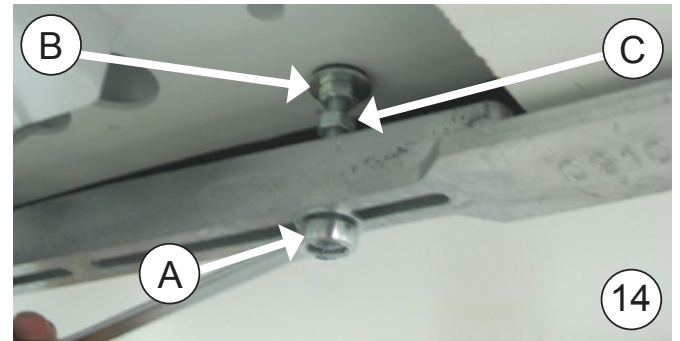

**15** **Important:**  
In order to prevent water from dripping, ensure the original edgeband is tight against the base of the unit, as shown in the diagram.

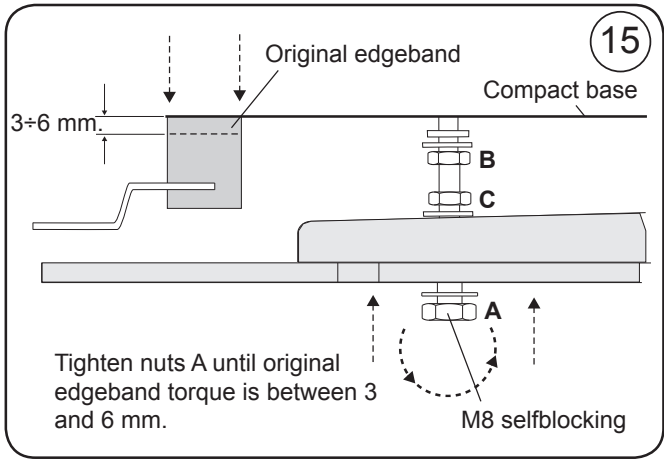
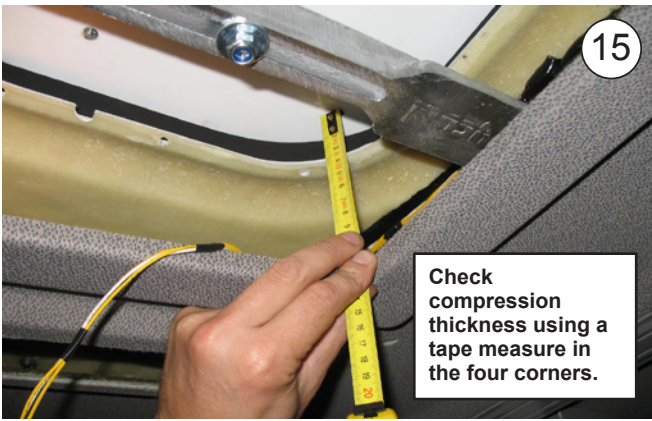

**16** Place console with (4) originale screws, put round 8 plastic trims on them.



**Exploded side view to supports fastening**

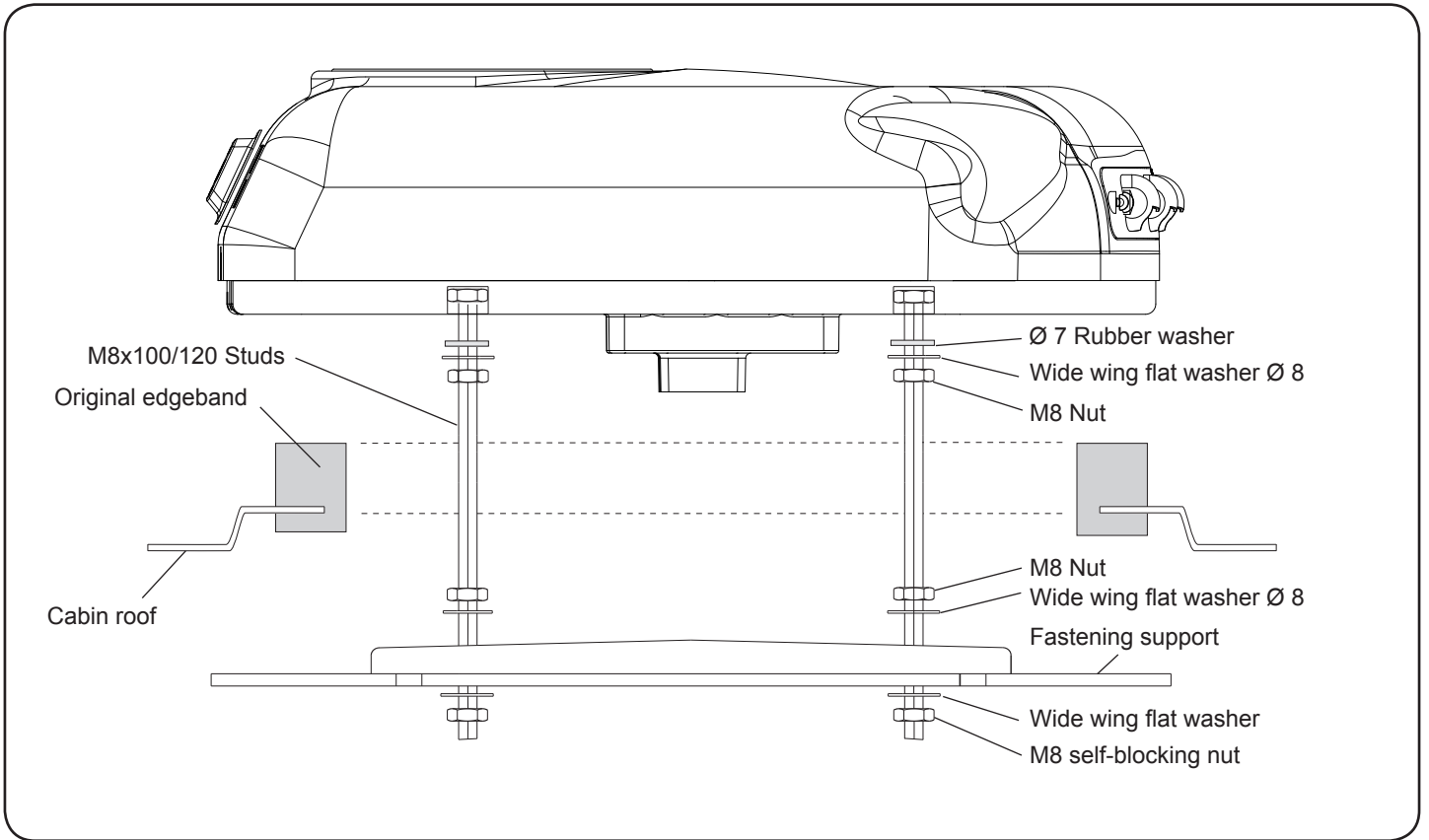

**Exploded rear view to consoles fastening**

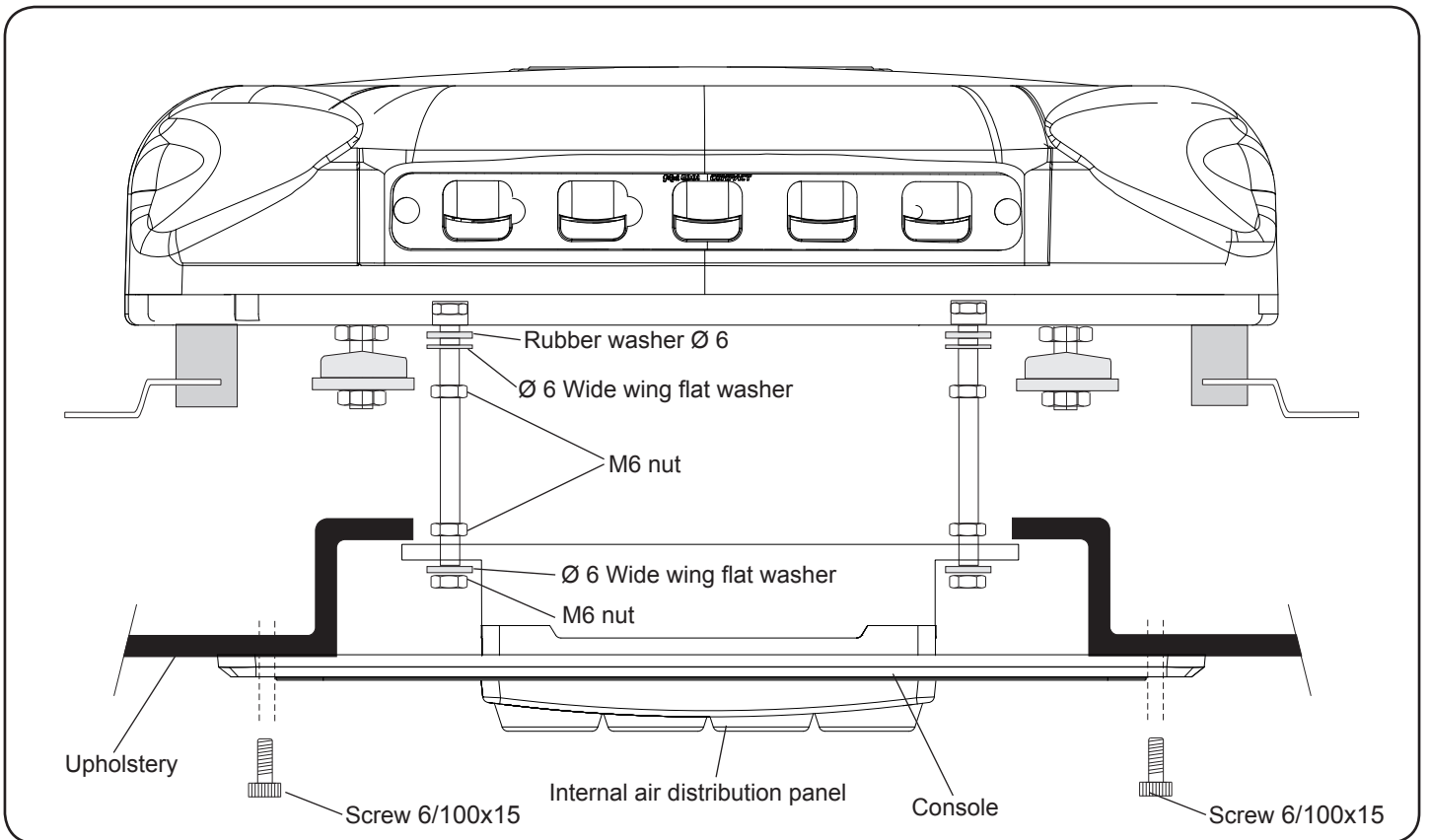

Detailed instructions  
on power wiring assembly



1- Lead equipment power cable up to the vehicle's battery, gluing plastic supports on rear cabin side and fastening it with flanges. Once cabin has been folded, lead cable along lower cabin side, fastening it with clamps and M4 screws and up to battery with flanges. It must follow the same passage as original cable (*thoroughly clean the area before gluing plastic supports*). When connecting equipment to battery, it will carry out a test of all its leds, **88-bd** will show on the display and it will then be turned off.

**IMPORTANT:** Due to the complex electronic control system of the unit, the current supply connection must be made directly to the battery, not to any other existing point available to feed other vehicle accessory or appliance, taking care of not changing polarity. Should polarity be inverted, the plate does not come on and the unit does not work (2).

**IMPORTANT:** Please consult User's Guide before starting.

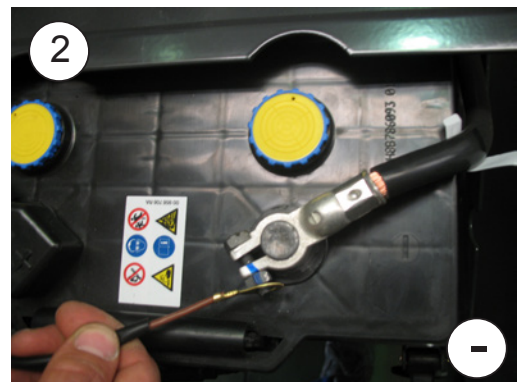
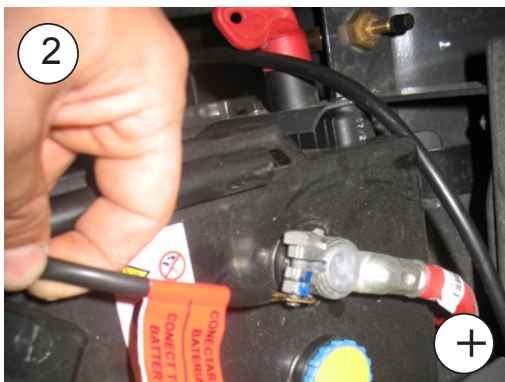

**IMPORTANT WARNING!**

**Take care** not to invert the polarities when connecting the equipment to the battery. If this happens, the plate does not come on and the unit does not work.

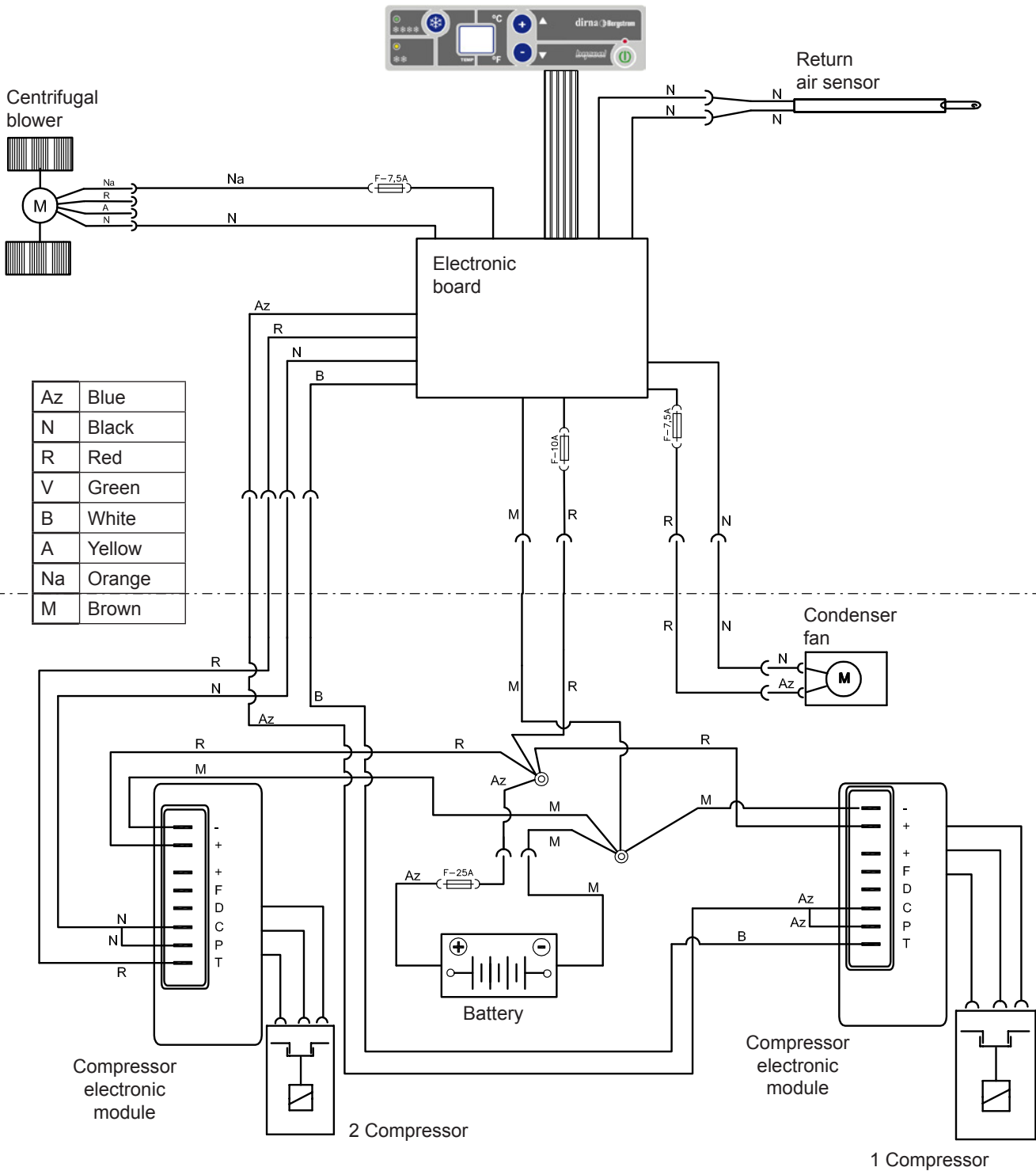

## Recommandations Pour Le Montage

- Avant de commencer le montage de l'appareil, prière de lire les instructions et de les suivre attentivement.
- Utiliser les outils convenant à chaque opération.

## Electricity

- Déconnecter la clé de contact.
- Déconnecter la batterie avant de commencer le montage.
- Vérifier le câblage des composants électriques et leur correcte installation.

## Attention

Si pendant le montage l'équipement est incliné, il faudra attendre au moins 60 minutes avant de le mettre en marche une fois qu'il aura été remis sur sa position horizontale.

## Attention

Lors de l'installation de l'appareil d'air conditionné sur le toit, il faudra protéger la partie supérieure de la cabine avec un linge ou une couverture de protection afin d'éviter les éventuelles égratignures.

Durant l'installation du **Compact**, tenir compte du fait que normalement les cabines pourvues d'écouille possède une structure suffisamment solide pour supporter le poids de l'appareil. Cependant, si ce n'est pas le cas et qu'il est nécessaire de découper le toit ou même si disposant d'écouille, la structure n'est pas suffisamment rigide (si elle était en fibre, plastique, etc.) il appartiendra à l'installateur de décider s'il faut renforcer le toit pour éviter toute déformation, rupture ou voie d'eau, etc., et prendre les mesures nécessaires à cet effet.

## Outils

Jeu de clés Torx  
 Jeu de clés Allen  
 Clé fixe 10, 13, 14  
 Ciseaux  
 Mètre

## Documentation included

Instructions de montage	1001207463
Guide de l'utilisateur	1001204545
Solution des problèmes	1001204543
Garantie	220AA10017

## Symbologie



Fragile





Attention aux coupures !



Risque électrique

## Garantie

 L'installateur devra posséder la formation pertinente en air conditionné sur véhicules.

 **dirna Bergstrom, s.l.**, ne sera pas responsable des dommages ou des bris dérivés d'une installation ou d'une manipulation incorrecte ni des modifications réalisées sans autorisation expresse par écrit.

 **Appareil pré-chargé de gaz réfrigérant, R-134. (Ne pas manipuler le circuit de gaz réfrigérant).**

 Voir la **procédure de garantie** du produit au **Diagnostic de problèmes**.

 Voir le **Guide de l'Usager** de l'appareil pour le fonctionnement correcte de la télécommande et du tableau de commande.

 Après l'installation, vous devez fournir à l'utilisateur: Manuel d'utilisation, garantie et diagnostic de pannes.

 Avant de commencer le montage, monter la grille d'entrée d'air frontale.



**1** Démontez le couvercle de l'écouille, les éléments de fixations et les remettez au client.



**2** **EXTERIEUR CABINE:**  
Placer le Compact dans le creux de l'écouille sur la baguette d'origine.  
**Attention !** Avant de placer l'équipement sur le creux de l'écouille, vérifier que les sorties d'écoulement ne soient pas bouchées.

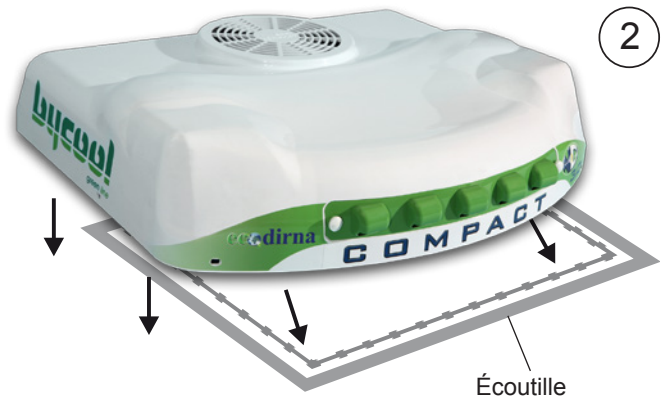

**3** Placer le canalisateur en caoutchouc mousse en laissant la partie la plus molle sur la base de l'équipement.  
**Attention:** en fonction de la cabine, il est possible de devoir utiliser les (2) canalisateurs fournis pour que le panneau de distribution d'air reste totalement ajusté avec ces derniers.



**4 INTERIEUR CABINE:**

Visser 5 mm environ (4) goujons de 8/125x100 ou 140 mm, en fonction de la distance plus ou moins grande de l'appareil jusqu'à ce qu'en positionnant les supports de fixation, il ne reste que 20 mm au-dessous de ces supports.

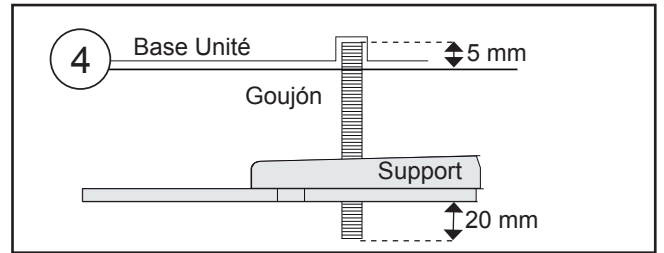

**5** En suivant cet ordre :

- rondelle a mouse
- rondelle plain diamètre 8 aile large
- écrou M8
- plain rondelle diamètre 8 aile large

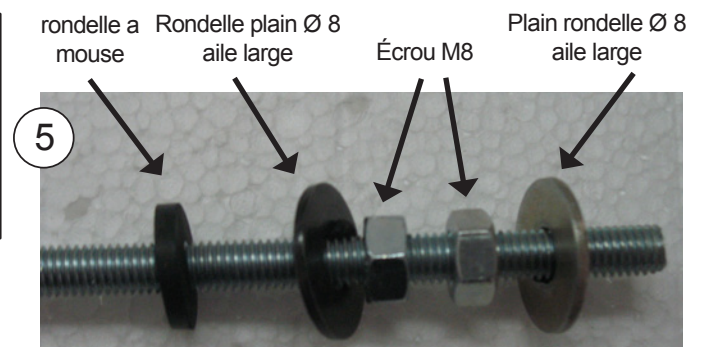

**6** Placer les supports de fixation (2), avec une rondelle (1) et un écrou autobloquant (1) M8, sans serrer.

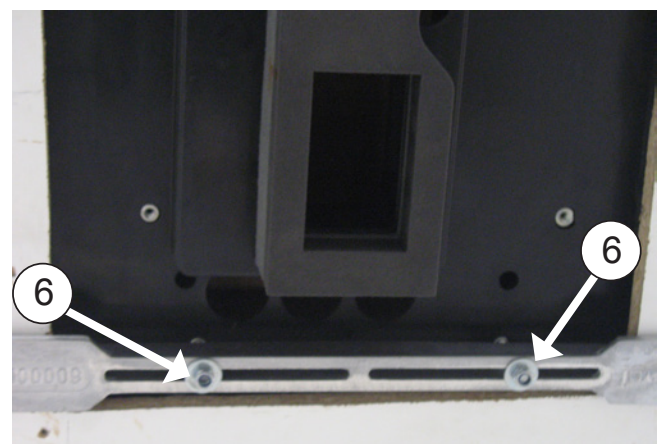
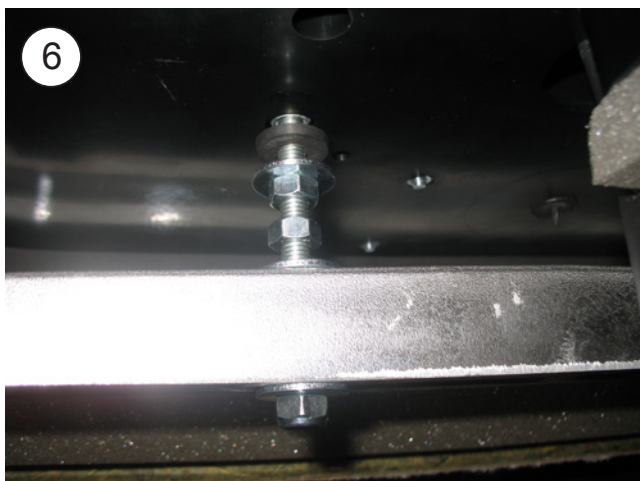



**7** Visser 10 mm les goujons (4) M6 x 80, comme indiqué au (A) du schéma point 11.

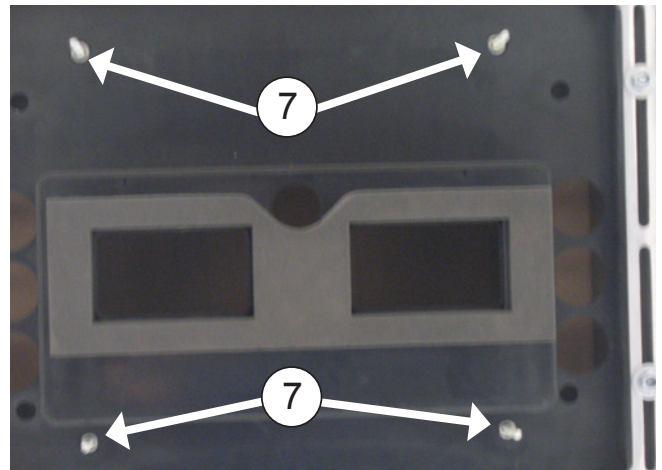
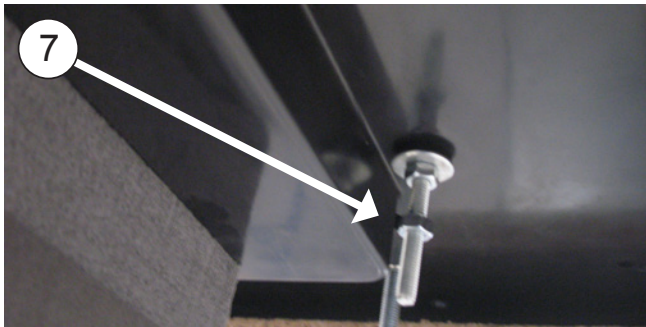

**8** Placer (1) rondelle mousse diamètre 6 (1) plain rondelle diamètre 6 aile large et (1) écrou M6 sur chaqu'un des asperges M6. En suivant serrer l'écrou jusqu'au la rondelle à mousse reste un peu pressée.

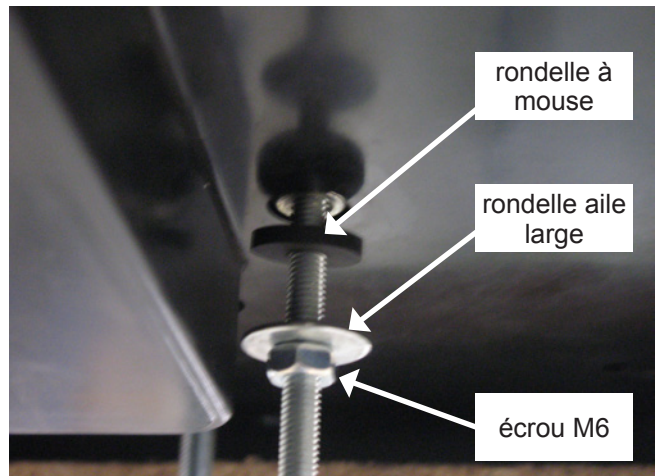

**9** Placer l'écrou (1) M6 sans le serrer sur chaque goujon.

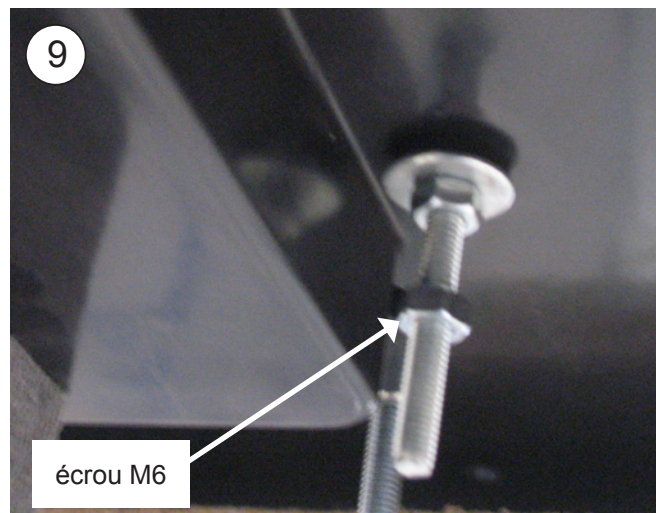

10

Connecter le boîtier à 2 voies du capteur de l'air de retour, le boîtier à 4 voies du souffleur et celui à 8 voies de connexion des câblages du contrôle électronique.

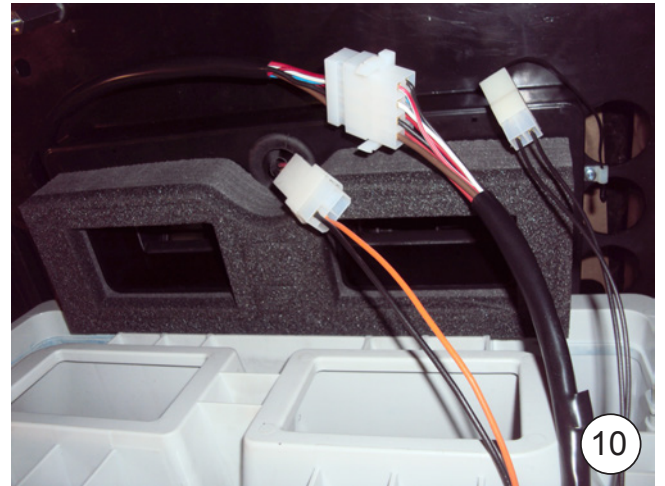

11

Placer le panneau intérieur de distribution d'air dans les goujons précédents avec (1) rondelle M6 surface large et (1) écrou M6 sur chaque goujon. Serrer les écrous jusqu'à ce que le canalisateur du panneau intérieur de distribution d'air heurte le caoutchouc mousse supérieur de l'équipement.

**Important : le canalisateur du panneau intérieur de distribution d'air doit heurter le caoutchouc mousse supérieur de l'équipement pour éviter des fuites d'air.**

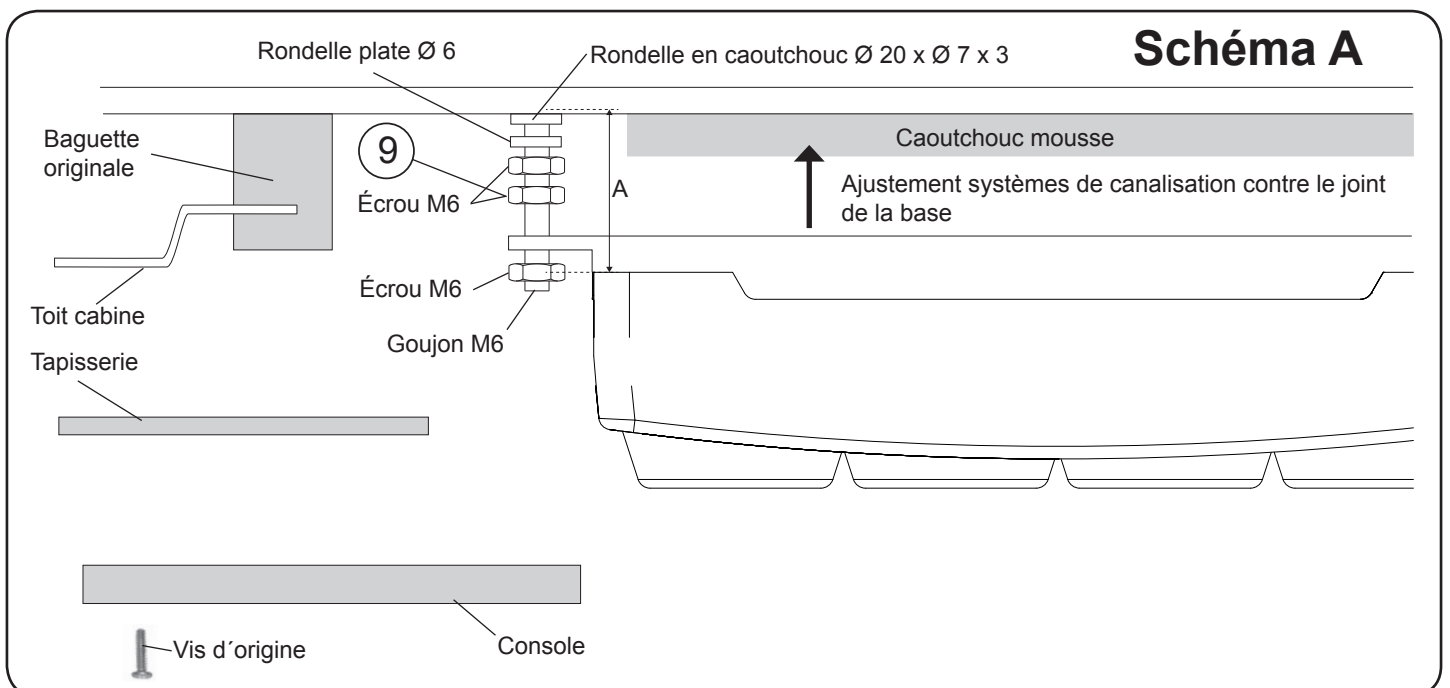

**12** Serrer l'écrou du point 9 jusqu'à atteindre la partie supérieure du panneau intérieur de distribution d'air.

**13** Présenter la console et centrer le Compact jusqu'à ce que les vis d'origine coïncident avec leur position d'origine.



**14** Après avoir réalisé ces opérations, démonter la console pour fixer les supports en serrant les écrous (A) jusqu'au serrage de la baguette originale avec la base de l'équipement. Ensuite, serrer les écrous (B) et (C) (voir schéma).

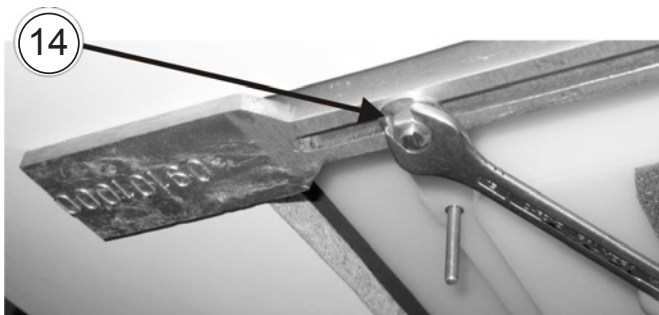
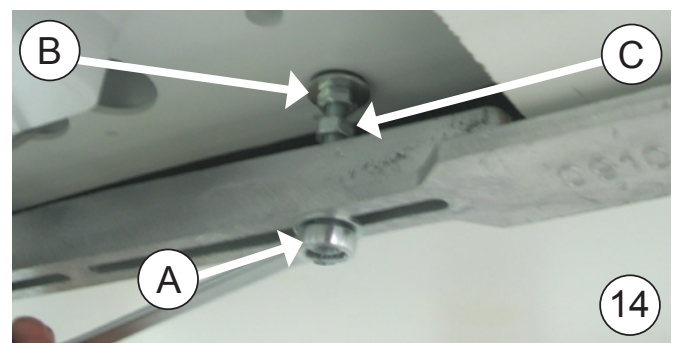

15

**Important:**

Pour éviter de possibles filtrations d'eau, assurer le serrage de la baguette originale avec la base de l'équipement comme indique le schéma.



Vérifier la compression du joint EPDM en utilisant un flexomètre dans les quatre coins.

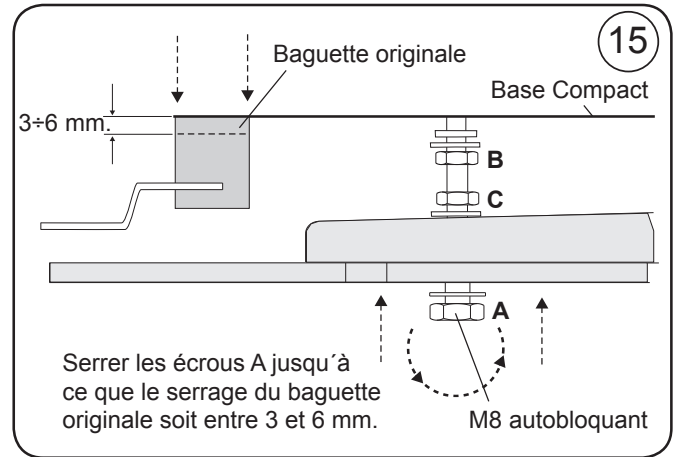

Serrer les écrous A jusqu'à ce que le serrage du baguette originale soit entre 3 et 6 mm.

M8 autobloquant

16

Couvrir les têtes des vis Allen (4) M6/100x15 avec les capuchons en plastique M6.



**Vue explosée jusqu'à la fixation des supports de fixation**

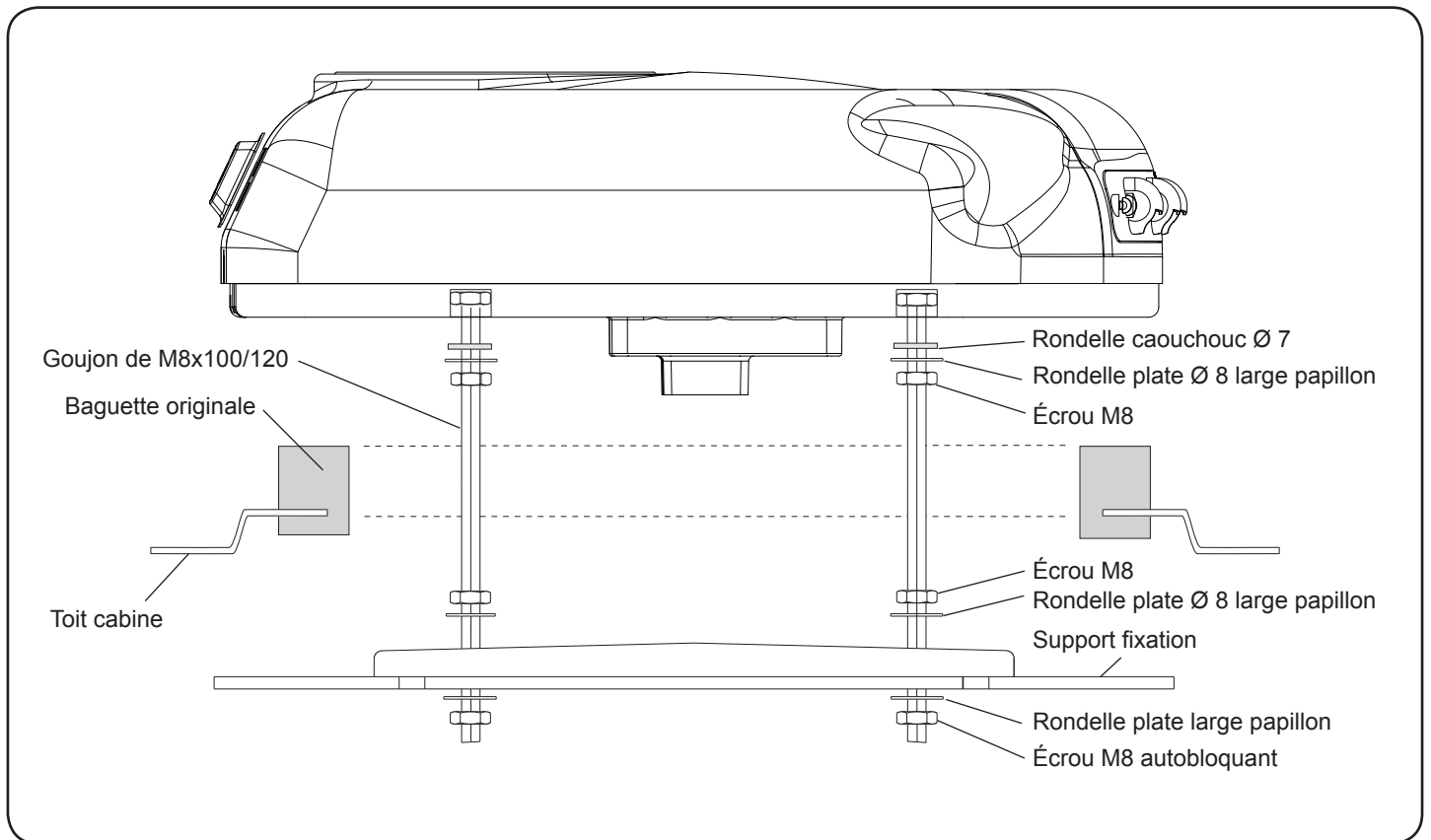

**Vue explosée jusqu'à fixation des consoles**

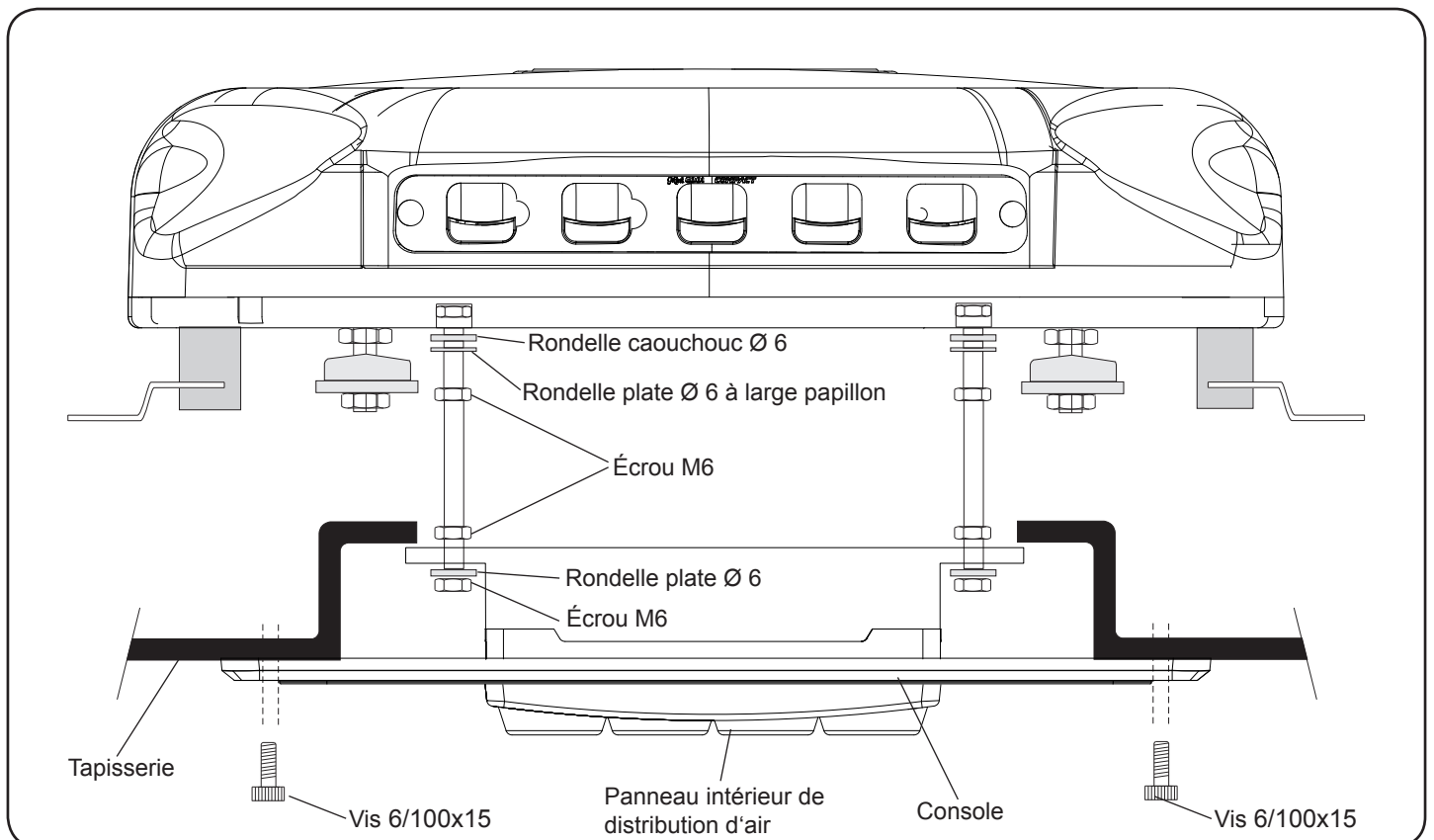

## Instructions détaillées sur l'installation du câblage d'alimentation



1- Conduire le câble d'alimentation de l'équipement jusqu'à la batterie du véhicule, en collant les supports de plastique sur la partie supérieure de la cabine et en le fixant avec des brides. Ensuite, la cabine étant rabattue, passer le câble le long de la partie inférieure de celle-ci en l'attachant avec des colliers et des vis M4 et jusqu'à la batterie avec des brides. Il faut utiliser le même passage que celui du câblage d'origine (*pour coller les supports en plastique, bien nettoyer la zone préalablement*). Lorsque l'équipement sera connecté à la batterie, celui-ci testera tous ses leds, puis sera affiché sur le **88--bd** et s'éteindra.

**Important:** le câblage doit être connecté directement à la batterie du véhicule, faire attention de ne pas inverser la polarité de la connexion à la batterie, la plaque de commande ne s'allumerait pas et l'équipement ne fonctionnerait pas. (2).

**Important:** Pour la mise en marche, consulter le Manuel de l'Utilisateur.

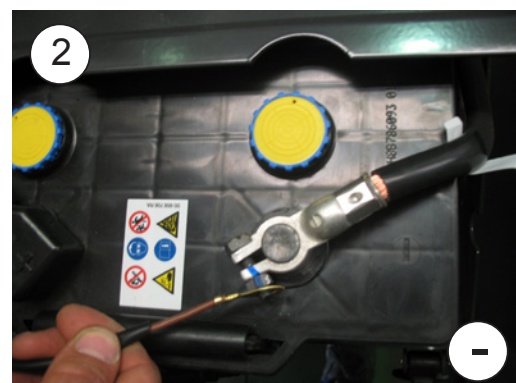

**AVERTISSEMENT IMPORTANT!**

**Attention** de ne pas inverser les polarités au moment de connecter l'équipement à la batterie. Si cela se produisait, la plaque de commande ne s'allumerait pas et l'équipement ne fonctionnerait pas.

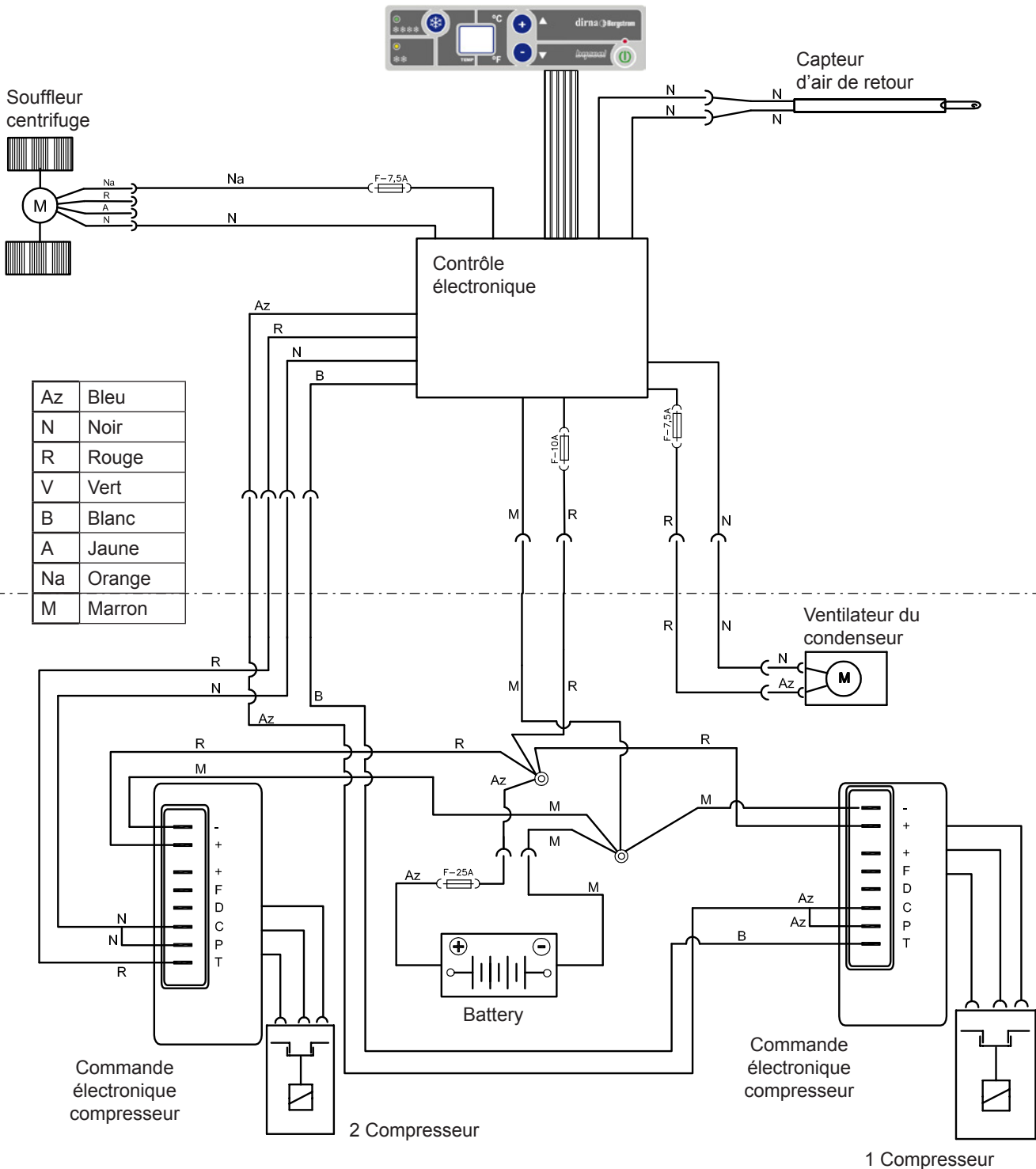

**Empfehlungen  
Zur montage**

- Vor und während der Montage bitte diese Anweisungen lesen und beachten.
- Benutzen Sie für jeden Arbeitsschritt die geeigneten Werkzeuge.

**Elektrizität**

- Zündschlüssel abziehen.
- Vor Montagebeginn die Batterie abklemmen.
- Den ordnungsgemäßen Anschluss und die korrekte Installation der Elektrokomponenten überprüfen.

 **Achtung**

Sollte sich das Gerät während der Montage neigen, muss man mindestens 60 Minuten warten, nachdem es wieder in die horizontale Lage gebracht wurde, um es wieder einzuschalten.

 **Achtung**

Wird die Klimaanlage im Kabinendach installiert, muss der obere Teil der Kabine mit einem Tuch oder einer Decke gegen eventuelle Kratzer geschützt werden. Bei der Installation der **Compact** auf dem Kabinendach muss darauf geachtet werden, dass mit Luken ausgestattete Kabinen über eine ausreichend stabile Struktur verfügen, um das Gewicht des Geräts stand zu halten. Sollte das Fahrzeug über keine Luke verfügen und sollte es notwendig sein, das Kabinendach aufzuschneiden, bzw. sollte die vorhandene Struktur nicht ausreichend stabil sein (z.B. wenn sie aus Faser, Kunststoff usw. hergestellt ist), obliegt es dem Installateur zu entscheiden, ob das Kabinendach zur Vermeidung von Verformungen, Brüchen, undichten Stellen usw. verstärkt werden muss, und die hierfür notwendigen Mittel bereit zu stellen.



**Werkzeuge**

- Torx-Schraubenschlüssel
- Inbusschraubenschlüssel
- 10er, 13er, 14er Schraubenschlüssel
- Schere
- Metermaß







**Mitgelieferte unterlagen**

Montageanweisungen	1001207463
Benutzerleitfaden	1001204545
Fehlerdiagnose	1001204543
Garantie	220AA10017

**Symbologie**

-  Fragile
-  Attention aux coupures !
-  Risque électrique

 **Warnhinweise**

-  Der Installateur muss im Bereich Fahrzeug-Klimaanlagen ausreichend geschult sein.
-  **dirna Bergstrom, s.l.** übernimmt keine Verantwortung für Schäden oder Brüche aufgrund einer nicht ordnungsgemäßen Installation oder Bedienung des Geräts oder den Austausch von Teilen bzw. Umbauten, die ohne die erforderliche schriftliche Genehmigung durchgeführt wurden.
-  **Mit Kältemittel vorgefülltes Gerät, R-134a. (Kältemittelkreislauf nicht manipulieren).**
-  Siehe **Garantieverfahren** des Produkts in der **Fehlerdiagnose**.
-  Siehe **Benutzerleitfaden** des Geräts für den ordnungsgemäßen Betrieb der Fernbedienung und des Bedienfelds.
-  Die folgenden Unterlagen müssen dem Benutzer nach der Installation ausgehändigt werden: **Benutzerleitfaden, Garantie und Fehlerdiagnose.**



 Vor Montabeginn vorderes Lufteintrittsgitter montieren.



**1** Den Lukendeckel und die Befestigungselemente entfernen und dem Kunden aushändigen.



**2** **KABINENAUSSENSEITE:**  
Compact in der Lukenaussparung auf den Original-Kantenabdeckungen positionieren.  
**Achtung! Beim Auflegen des Geräts auf die Lukenaussparung darauf achten, dass die Ablassausgänge nicht.**

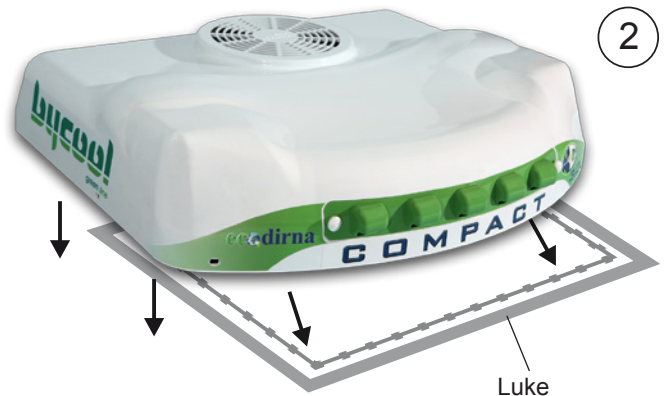

**3** Schaumgummidurchführung anbringen, wobei der weichere Teil auf der Gerätegrundplatte aufliegt.  
**Achtung:** Je nach Kabine kann es erforderlich sein, die (2) mitgelieferten Führungen zu verwenden, damit die Luftverteiltertafel ordnungsgemäß ausgerichtet ist.



4

**KABINENINNENSEITE:**

Ca. 5 mm Gewinde für (4) Stiftschrauben 8/125x70, 100 oder 120 mm schneiden (abhängig vom größeren oder kleineren Abstand vom Gerät bis sie nach Positionierung der Befestigungsauflagen 20 mm unter diesen liegen).

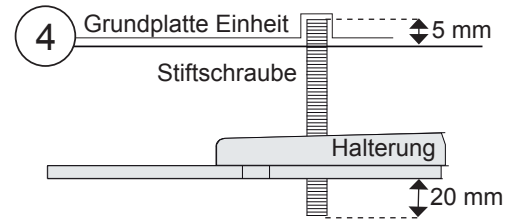

5

Montieren Sie wie folgt:  
Gummischeibe / 3D Unterlegscheibe / Mutter / Gewindestange

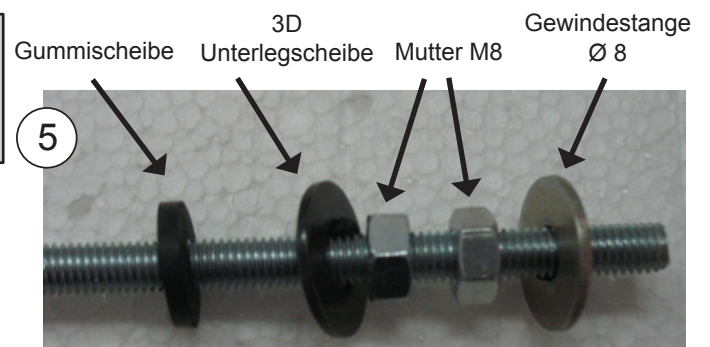

6

Befestigungsauflagen (2) mit einer Unterlegscheibe (1) und einer Autobloc-Mutter (1) M8 einlegen, **jedoch ohne anzuziehen**.

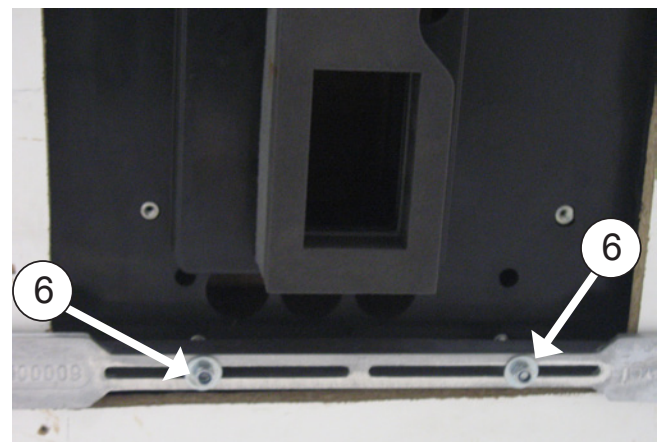
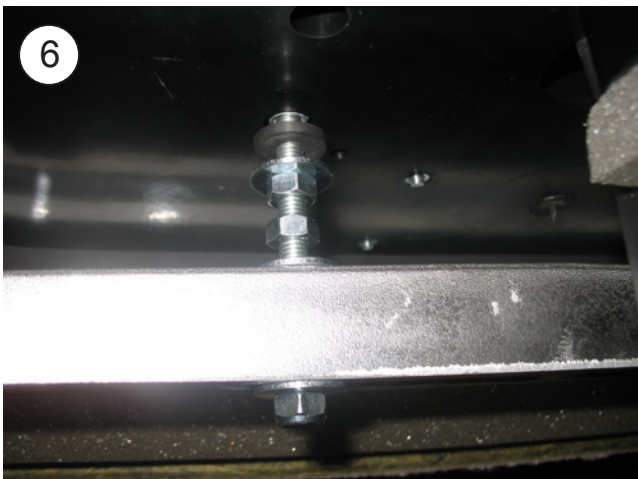

**7** 10 mm Gewinde für die Stiftschrauben (4) M6 x 80 am angegebenen Punkt schneiden laut Distanz (A) beschrieben in Abbildung 11.

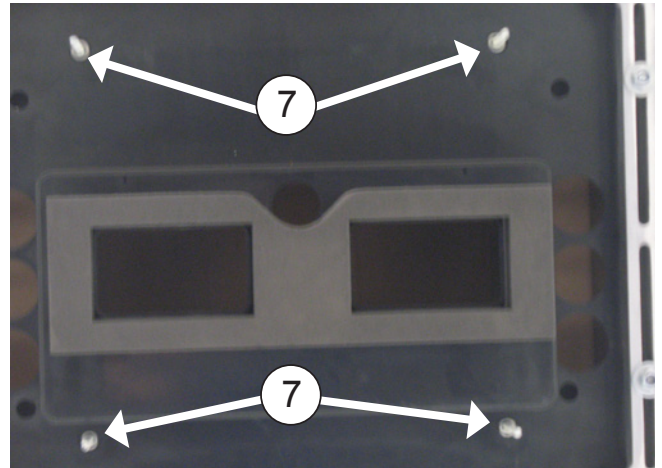
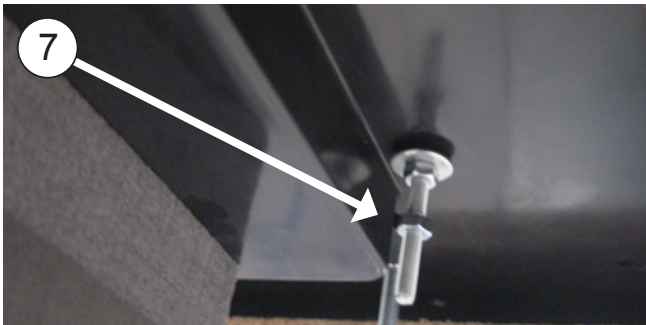

**8** Montiere (1) Gummi-Unterlegscheibe, (1) 3D Unterlegscheibe (1) Mutter auf jede Gewindestange. Später ziehen Sie die Mutter an, bis die Gummischeibe ein wenig zusammengedrückt ist.

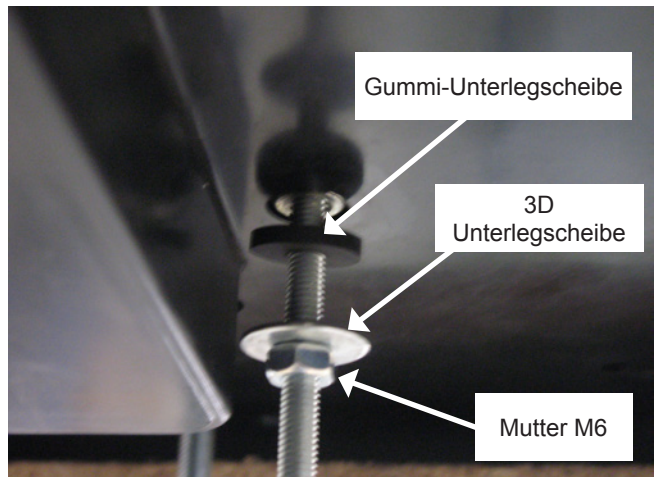

**9** Jeweils die Mutter (1) M6 **ohne Anziehen** auf die Stiftschrauben legen.

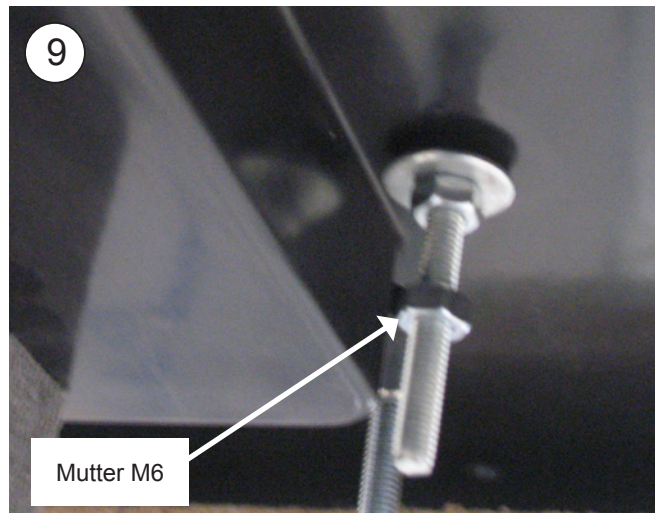

**10** Den 2-Wege-Kasten des Abluftensors, den 4-Wege-Kasten des Gebläses und den 8-Wege-Kasten der Kabel der Elektroniksteuerung anschließen.

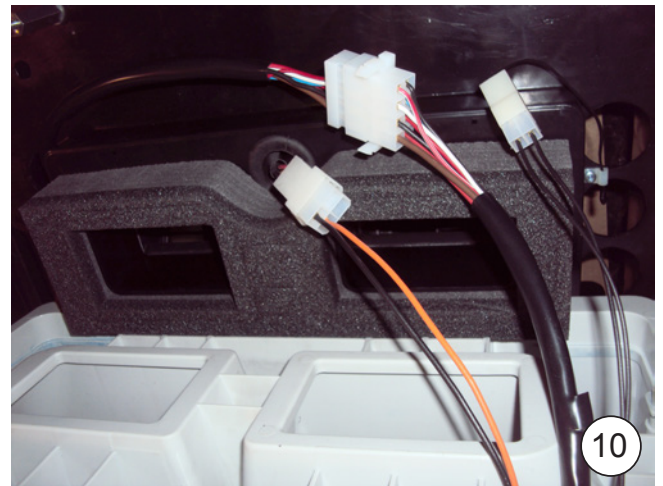

**11** Innere Luftverteiltertafel an den vorgenannten Stiftschrauben mit jeweils (1) Breitflansch-Unterlegscheibe M6 und (1) Mutter M6 anbringen. Muttern anziehen, bis die Führung der inneren Luftverteiltertafel an das obere Schaumgummi der Anlage anschlägt.

**Wichtiger Hinweis: Die Führung der inneren Luftverteiltertafel muss an das obere Schaumgummi anschlagen, damit keine Luft austreten kann.**

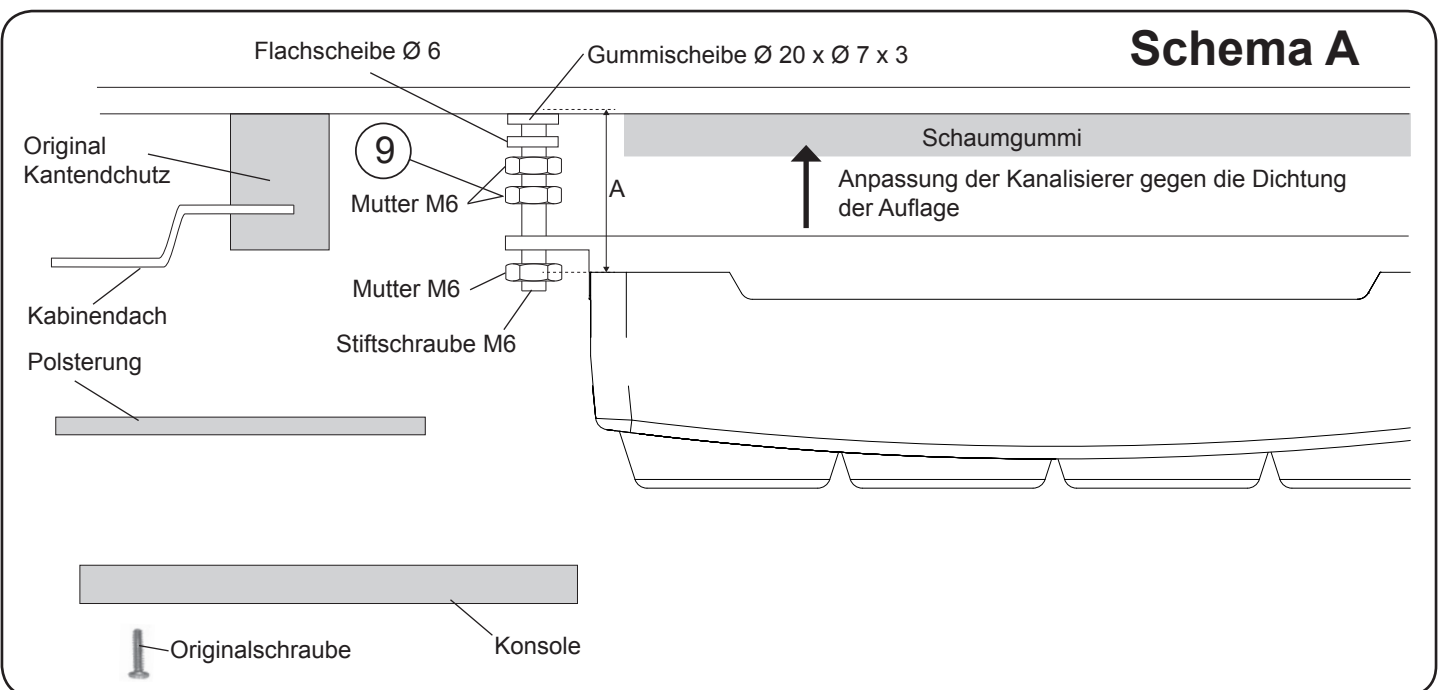

**12** Mutter aus Punkt 9 anziehen, bis diese an das Oberteil der Luftverteiltertafel stößt.

**13** Konsole vorlegen und Compact zentrieren, bis die Originalschrauben mit ihrer ursprünglichen Stelle.



**14** Danach die Konsole abmontieren um die Halterungen anzubringen durch Anziehen der Schraubenmutter (A) bis zum Andruck des original Kantenschutzes mit der Basis des Geräts. Anschließend die Schraubenmutter (B) und (C) andrehen (siehe Bild).

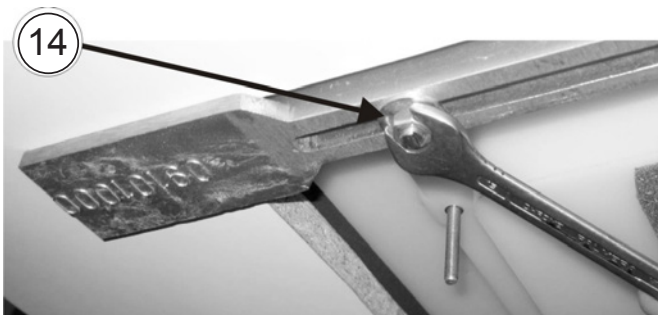
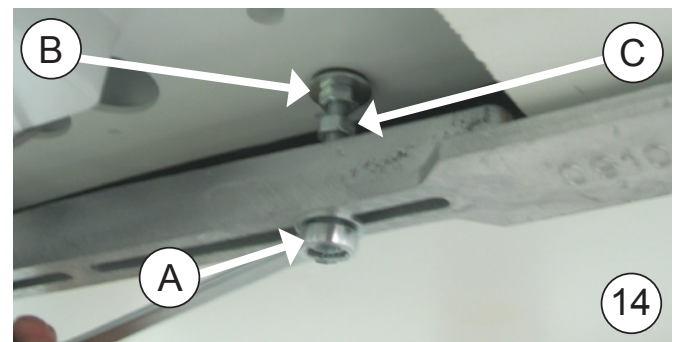

15

**Wichtig:**

Ummögliche Wasserinfiltration zu vermeiden den Andruck des original Kantenschutzes mit der Basis des Geräts sicherstellen, so wie auf dem Bild gezeigt wird.



Die Komprimierung der original Kantenschutz überprüfen anhand eines Stahlbaudmaßes in den vier Ecken.

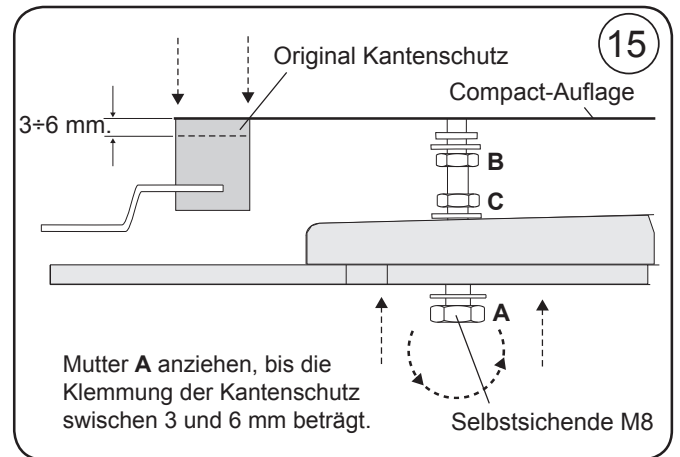

16

Konsole mit den (4) Originalschrauben anbringen und auf letztere runde Kunststoffzierabdeckungen 8 stecken.



**Explosionsansicht bis zur Befestigung der Befestigungsauflagen**

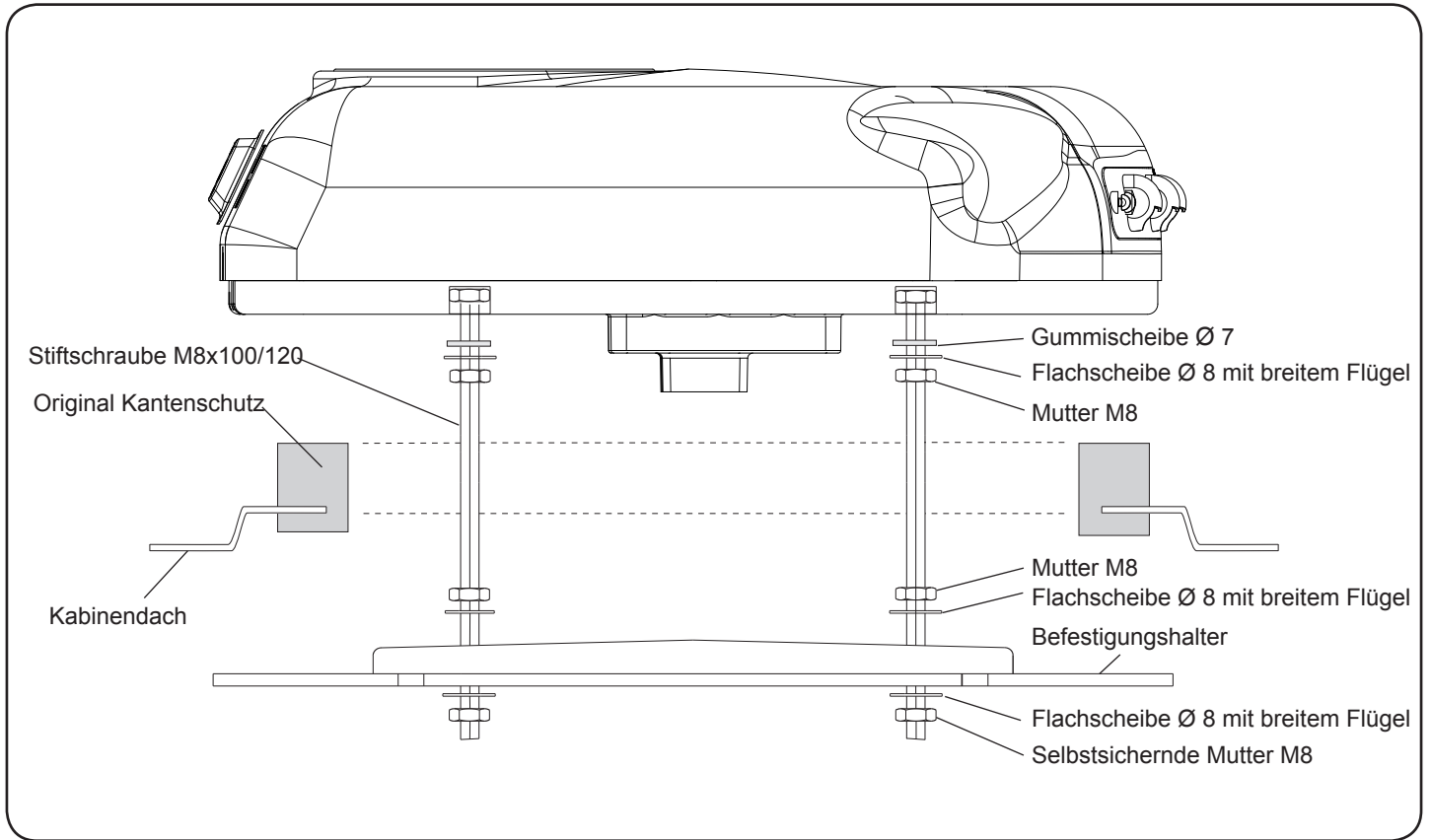

**Explosionsansicht bis zur Befestigung der Konsolen**

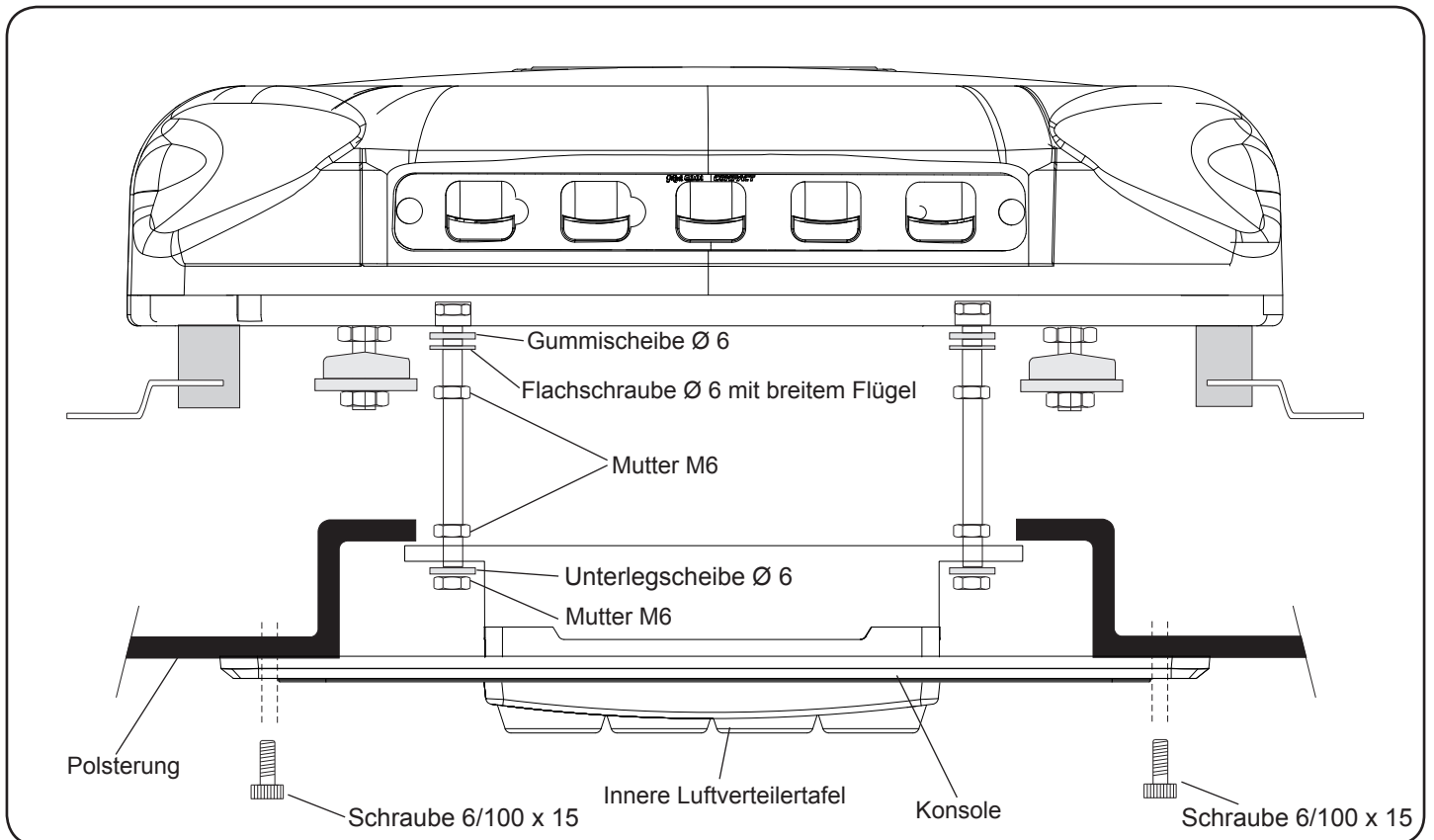

## Ausführliche Einleitungen über die Installation der Verkabelungsleitung



1- Stromversorgungskabel der Anlage bis zur Fahrzeugbatterie führen. Hierbei die Kunststoffhalter an die Rückseite der Kabine ankleben und mit Laschen fixieren. Danach mit abgeklappter Kabine, Kabel unterhalb der Kabine führen und mit den Schellen und M4 Schrauben befestigen; und bis zur Batterie mit den Laschen; es ist der gleiche Kabeldurchgang wie bei der Originalverkabelung zu verwenden. *(Zum Ankleben der Kunststoffhalter, Bereich vorher gründlich reinigen!)*. Beim Anschluss der Anlage an die Batterie, wird ein Test aller Leds durchgeführt, auf dem Display erscheint **88--bd** und geht dann aus.

**Wichtig:** Aufgrund des komplexen elektronischen Regelsystems der Anlage muss die Stromspeisung direkt an der Fahrzeugbatterie erfolgen, nicht an irgendeiner anderen Stelle, die andere Zubehörteile des Fahrzeugs betreibt, wobei ebenfalls zu achten ist, dass beim Anschluss (2) nicht eine Polaritätsumkehrung vorgenommen wird. Sie darauf, die Polaritäten beim Anschluss der Anlage an die Batterie nicht zu vertauschen. Ist dies der Fall, schaltet sich das Bedienfeld nicht ein und das Gerät funktioniert nicht. (2).

**Wichtig:** Zur Inbetriebsetzung ziehen sie das Bedienerhandbuch heran.

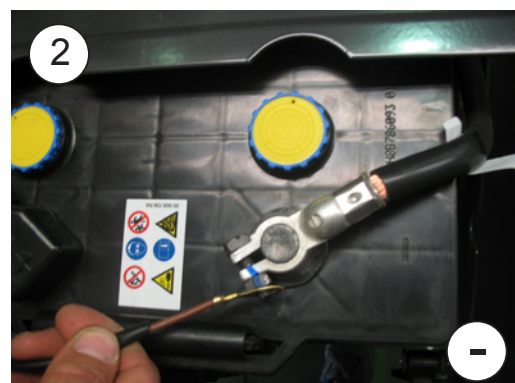



**WICHTIGER WARHNHINWEIS!**

**Achten** Sie darauf, die Polaritäten beim Anschluss der Anlage an die Batterie nicht zu vertauschen. Ist dies der Fall, schaltet sich das Bedienfeld nicht ein und das Gerät funktioniert nicht.

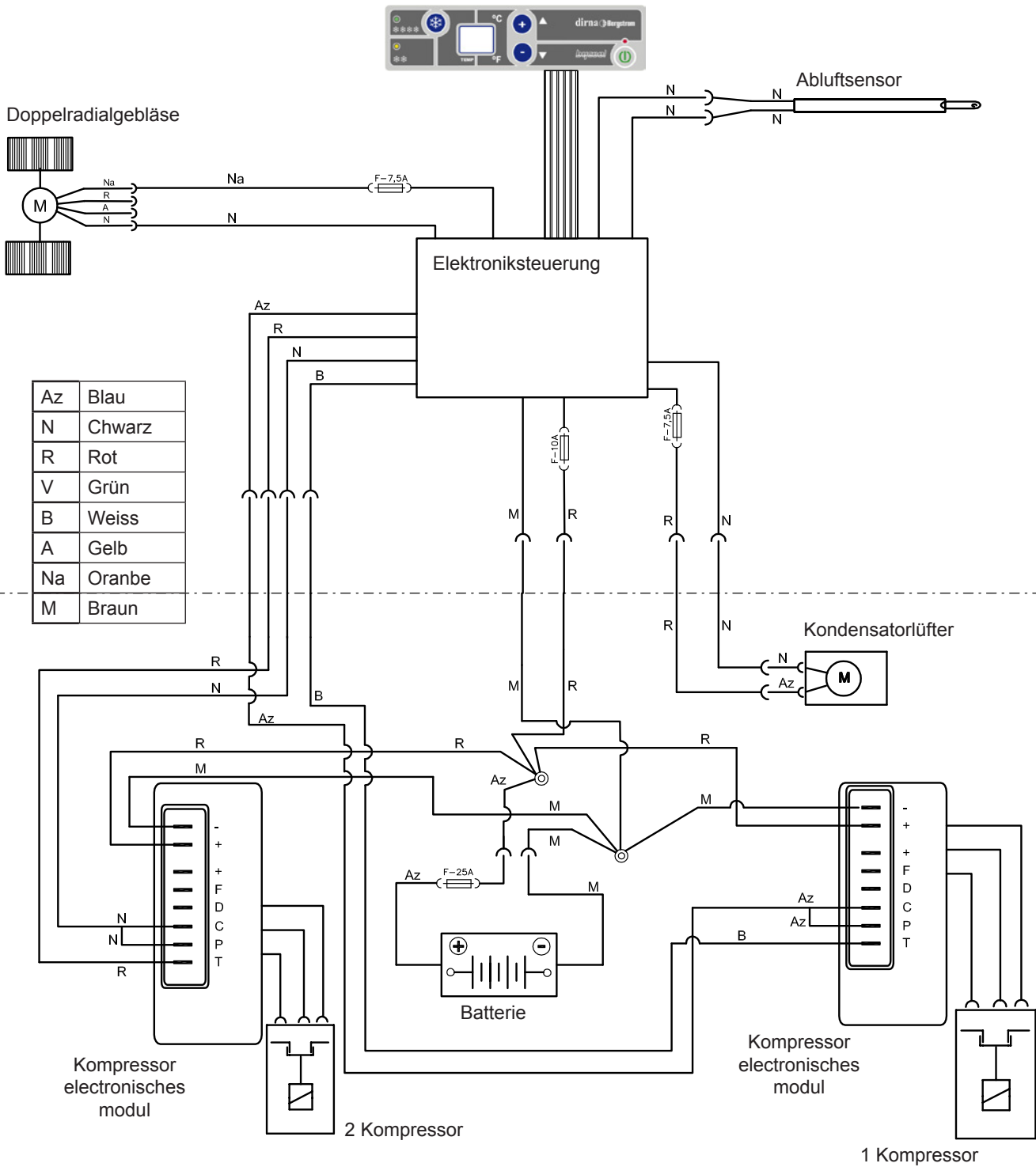

## Suggerimenti per il montaggio

- Prima di cominciare il montaggio, leggere attentamente le istruzioni e rispettarle nel corso dello stesso.
- Usare gli attrezzi più adatti ad ogni operazione.

## Elettricità

- Scollegare la chiave di contatto.
- Scollegare la batteria prima di cominciare il montaggio.
- Assicurarsi di avere effettuato correttamente l'installazione e il collegamento dei componenti elettrici.

## Attenzione

Se durante il montaggio si inclina l'impianto, prima di rimetterlo in funzione occorre attendere almeno 60 minuti dal momento in cui è di nuovo in posizione orizzontale.

## Attenzione

Quando si installa l'impianto di aria condizionata sul tettuccio, bisogna proteggere la parte superiore della cabina con uno straccio o una coperta per evitare eventuali graffi. Per l'installazione del **Compact**, tenere presente che normalmente le cabine munite di oblò dispongono di una struttura abbastanza solida per sostenere il peso dell'impianto. Tuttavia, se così non fosse e se fosse necessario tagliare il tettuccio, o se in presenza di oblò la struttura non fosse abbastanza rigida (se fosse di fibra, plastica, ecc.), è responsabilità dell'installatore decidere se occorre rinforzare il tettuccio per evitare qualsiasi deformazione, rottura o penetrazione d'acqua, ecc., prendendo le misure necessarie per evitarlo.

## Attrezzi

Kit di chiavi Torx  
 Kit di chiavi Allen  
 Chiave fissa 10, 13, 14  
 Forbici  
 Metro a nastro

## Documentazione allegata

Istruzioni di montaggio	1001207463
Guida dell'utente	1001204545
Soluzione dei problemi	1001204543
Garanzia	220AA10017

## Simbologia



Fragile









Attenzione alle mani



Tensione elettrica pericolosa

## Avvertenze

-  L'installatore deve essere in possesso della formazione necessaria in materia di aria condizionata per veicoli.
-  **dirna Bergstrom, s.l.** declina ogni responsabilità per danni o rotture derivanti dall'errata installazione o dall'errato uso dell'impianto o da sostituzioni o modifiche effettuate senza la necessaria autorizzazione per iscritto.
-  **Impianto precaricato con gas refrigerante, R-134a. (Non manomettere il circuito di gas refrigerante).**
-  Vedi la **procedura di garanzia** del prodotto in **Diagnosi dei problemi**.
-  Vedi la **Guida dell'utente** dell'impianto per il corretto funzionamento del telecomando e del pannello di controllo.
-  I seguenti documenti devono essere consegnati all'utente una volta conclusa l'installazione: **Guida dell'utente, Garanzia e Diagnosi dei problemi**.

 Prima di iniziare il montaggio, installare la griglia sull'entrata anteriore dell'aria.



**1** Smontare il coperchio dell'oblò, gli elementi di fissaggio e consegnarli al cliente.

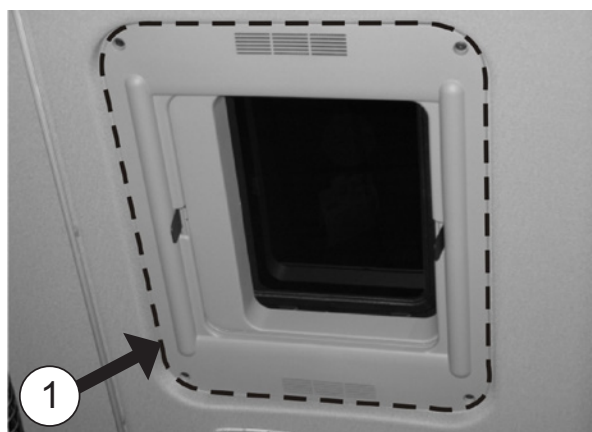

**2** **ESTERNO CABINA:**  
Inserire il Compact nel vano del tettuccio apribile sul coprispiglioli originale.  
**Attenzione! Quando si posiziona l'impianto sul vano del tettuccio apribile, controllare che le uscite di scarico non siano ostruite.**

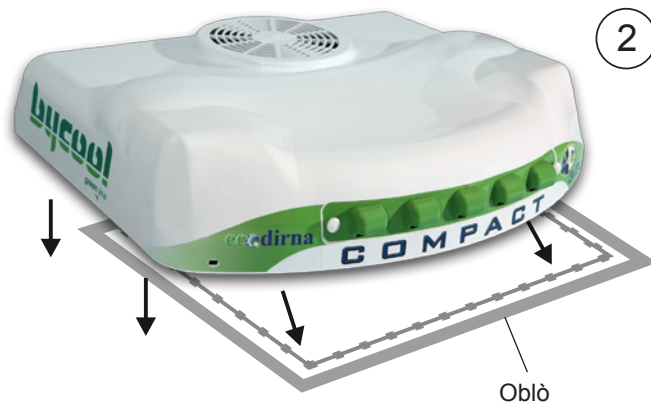

**3** Posizionare il canalizzatore di gommapiuma con la parte più morbida sulla base dell'impianto.  
**Attenzione:** A seconda della cabina, può essere necessario usare i (2) canalizzatori in dotazione per la completa adesione del pannello di distribuzione dell'aria ai medesimi.



**4 INTERNO CABINA:**

Avvitare di circa 5 mm le (4) viti prigioniere da 8/125x100 o 140 mm, a seconda della distanza (maggiore o minore) dall'impianto finché, posizionando i supporti di fissaggio, le viti non sporgono di 20 mm dagli stessi.

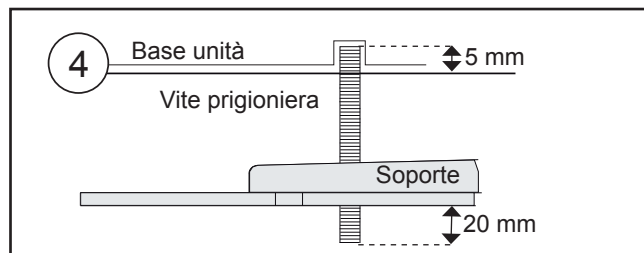

**5** Inserire (8) rondella di gomma Ø 7, (1) rondella piana Ø 1 a testa larga, (2) dadi M8 e (1) rondella piana Ø 8 a testa larga, su ciascuna vite prigioniera precedente, seguendo questo ordine.

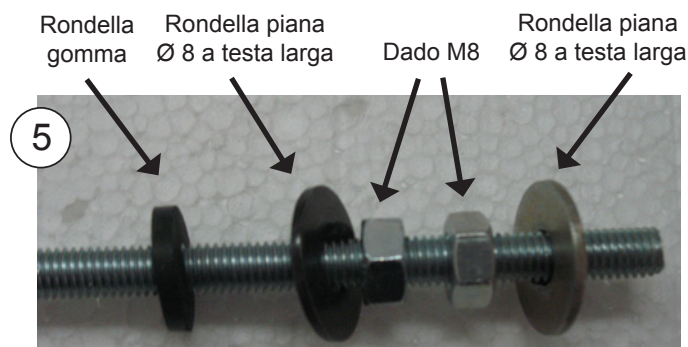

**6** Fissare i supporti di fissaggio (2), con una rondella (1) e un dado autobloccante (1) M8, senza stringere.

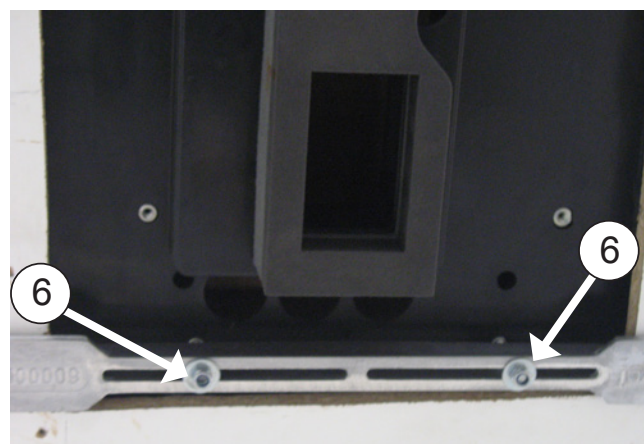
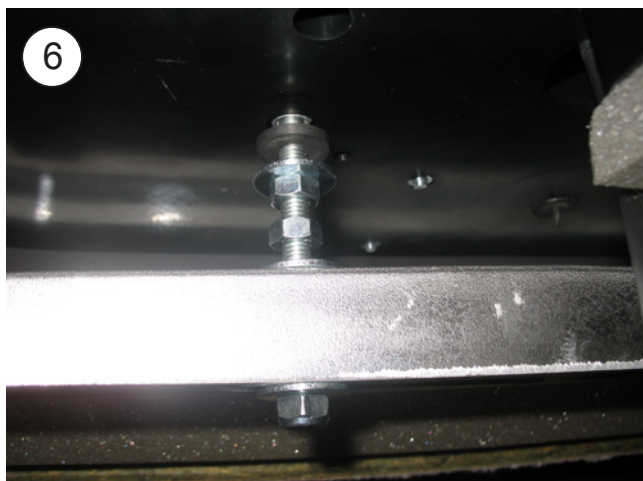

**7** Avvitare di 10 mm i perni (4) M6 x 80, dove indicato distanza (A) segun nella a figura 11.

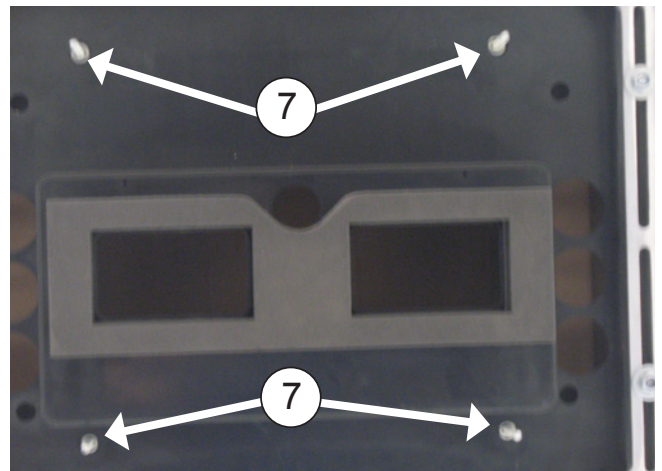
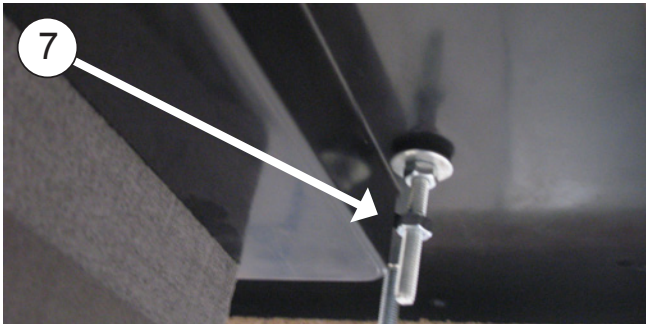

**8** Inserire (1) rondella Ø 6 di gomma, (1) rondella piana Ø 6 a testa larga e (1) dado M6 su ogni vite prigioniera M6. Quindi stringere il dado fino a premere leggermente la rondella di gomma.

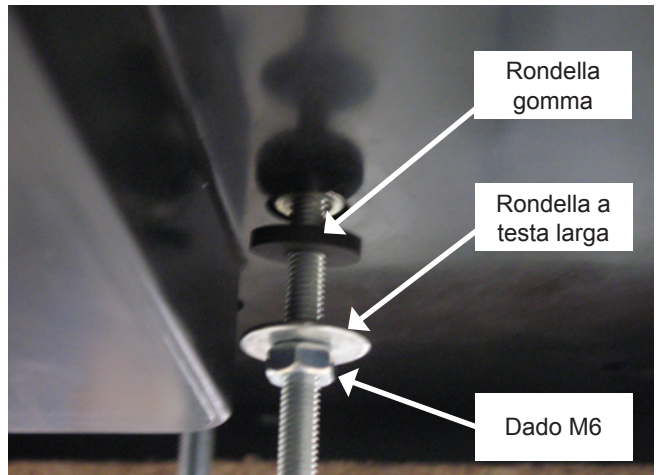

**9** Inserire il dado (1) M6 senza stringere in ogni vite prigioniera.

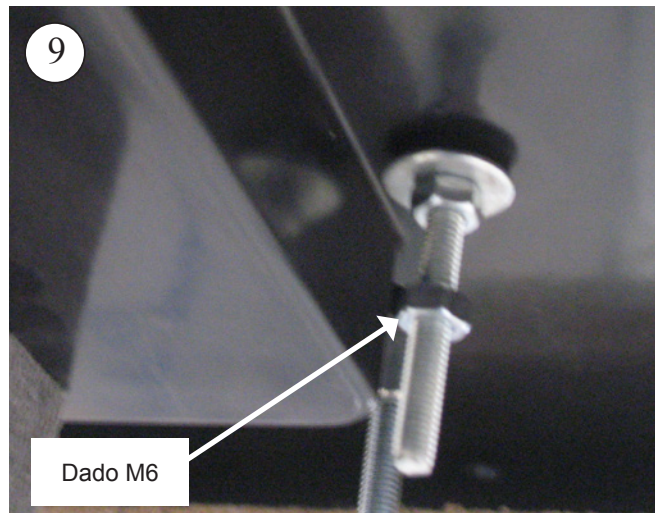

**10** Collegare la scatola a 2 vie del sensore dell'aria di ritorno, la scatola a 4 vie del ventilatore e quella a 8 vie di connessione dei cablaggi del controllo elettronico.



**11** Posizionare il pannello di distribuzione dell'aria sulle viti prigioniera anteriori con (1) rondella M6 a testa larga e (1) dado M6 su ogni vite prigioniera. Stringere i dadi finché il canalizzatore del pannello interno di distribuzione dell'aria non è a battuta sulla gommapiuma superiore dell'impianto.

**Nota bene: il canalizzatore del pannello interno di distribuzione dell'aria deve essere a battuta sulla gommapiuma superiore per evitare perdite d'aria.**

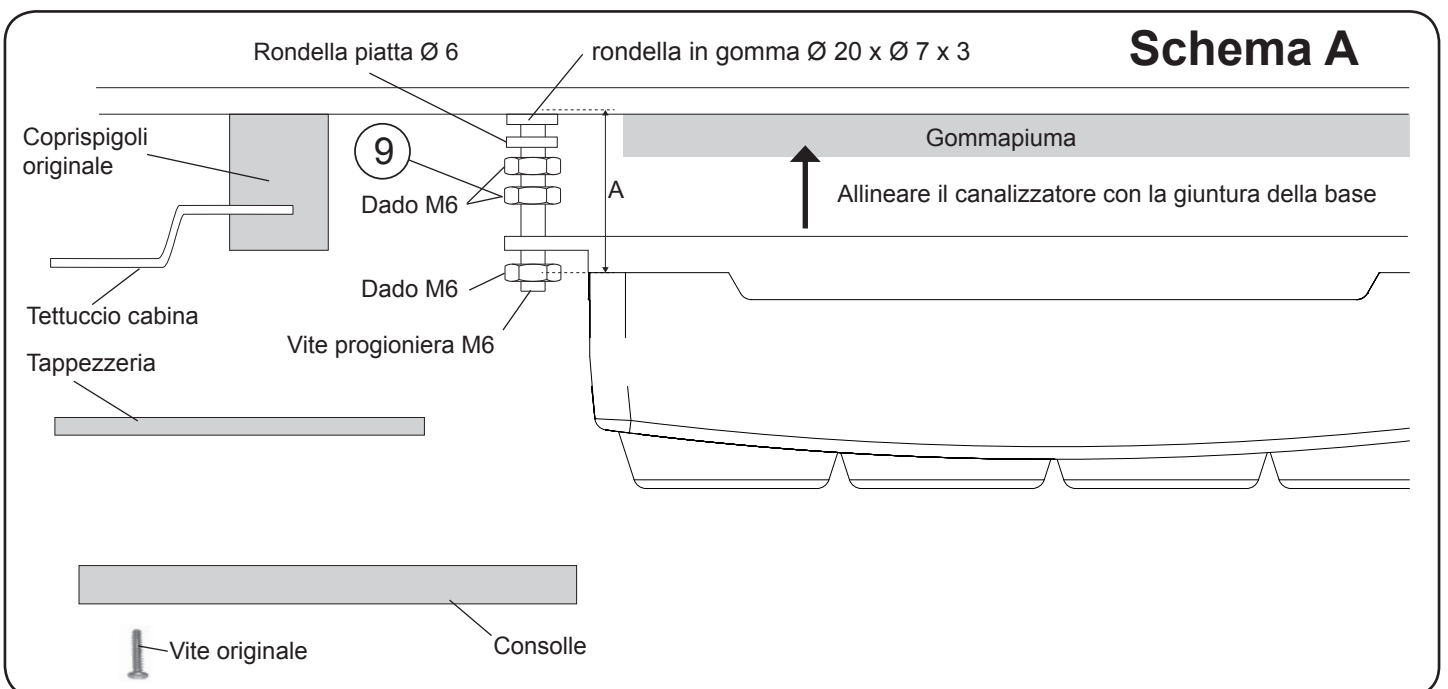

**12** Stringere il dado indicato al punto **9** finché non tocca la superficie superiore della parte frontale.

**13** Prendere la console e centrare il equipo fino far combaciare le viti originali con la loro posizione originale.



**14** Una volta eseguite queste operazioni, smontare la console per fissare i supporti stringendo i dadi (A) fino a serrare il coprispiglioli originale sulla base dell'impianto, dopo aver stretto i dadi (B) e (C). (vedi schema).

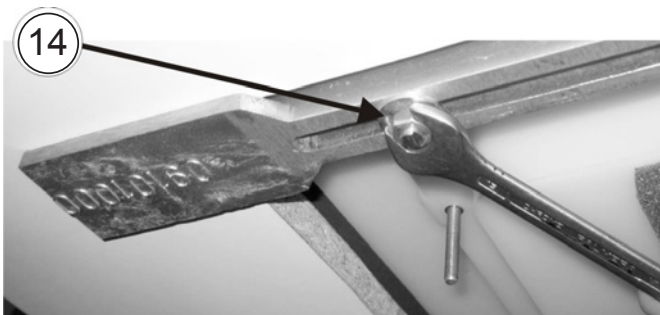
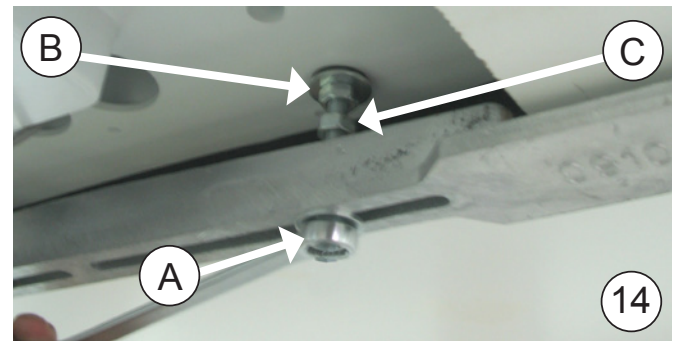

**15** **Nota bene:**  
Per evitare eventuali infiltrazioni d'acqua, verificare il corretto serraggio del coprispiglioli originale sulla base dell'impianto come indicato nello schema.



Comprovare la compressione della coprispiglioli originale usando un flexómetro nelle quattro angoli.

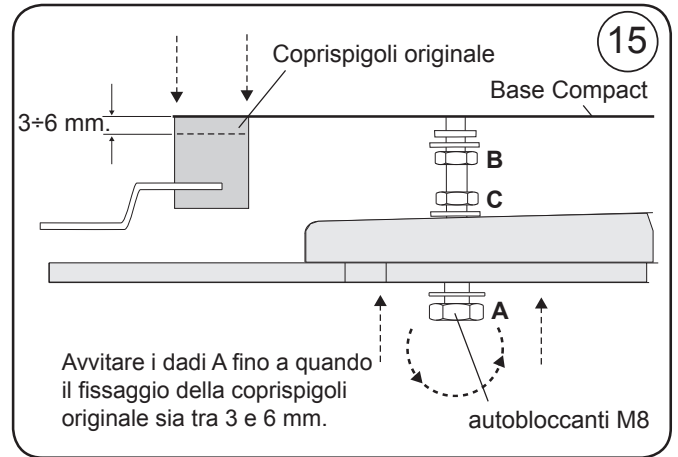

**16** Collocare la consolle con (4) viti originali e collocare sugli stessi le decorazioni (8) rotonde di plastica.





### Esploso fino al fissaggio dei supporti di fissaggio

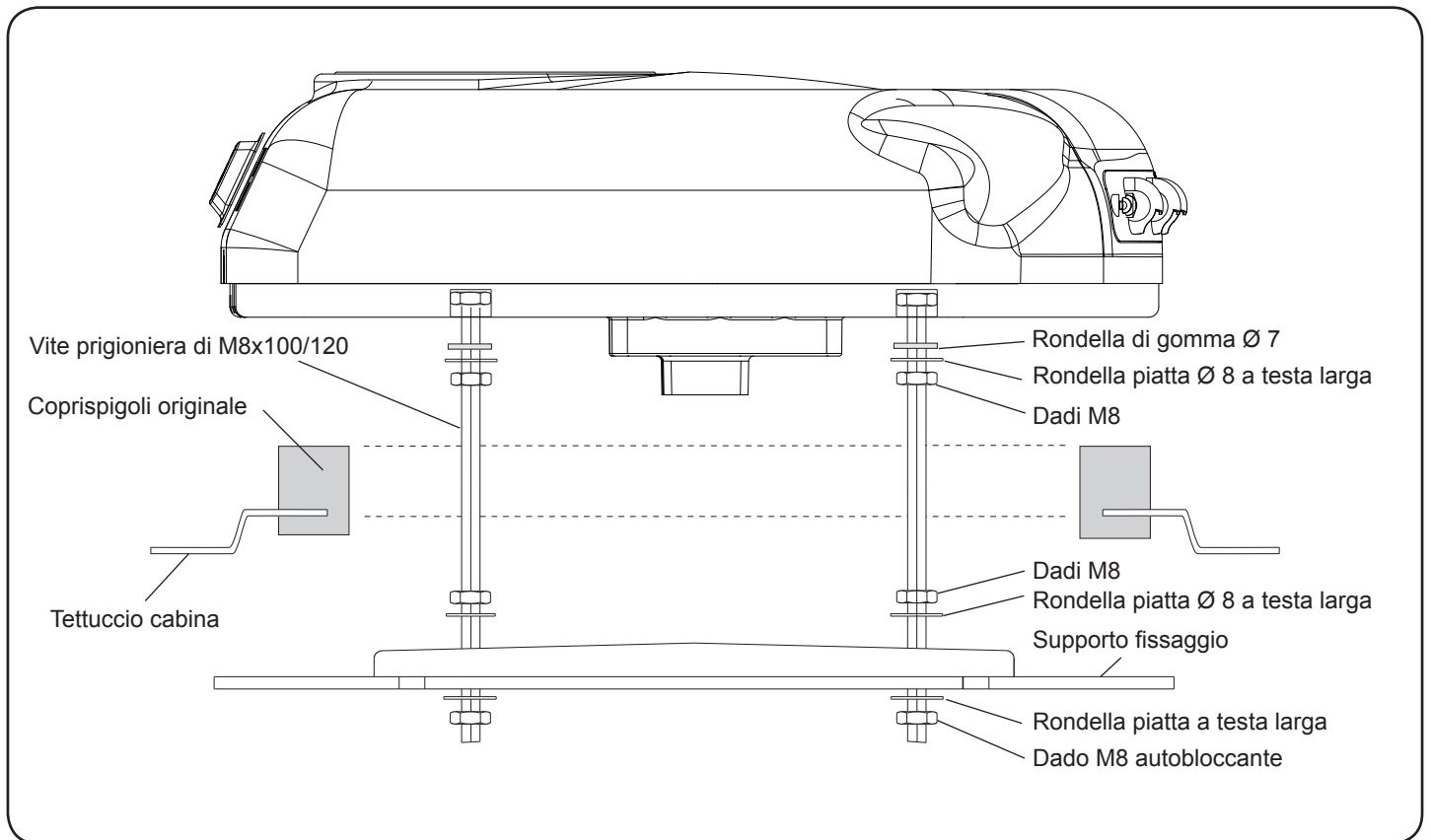

### Esploso fino al fissaggio della consolle

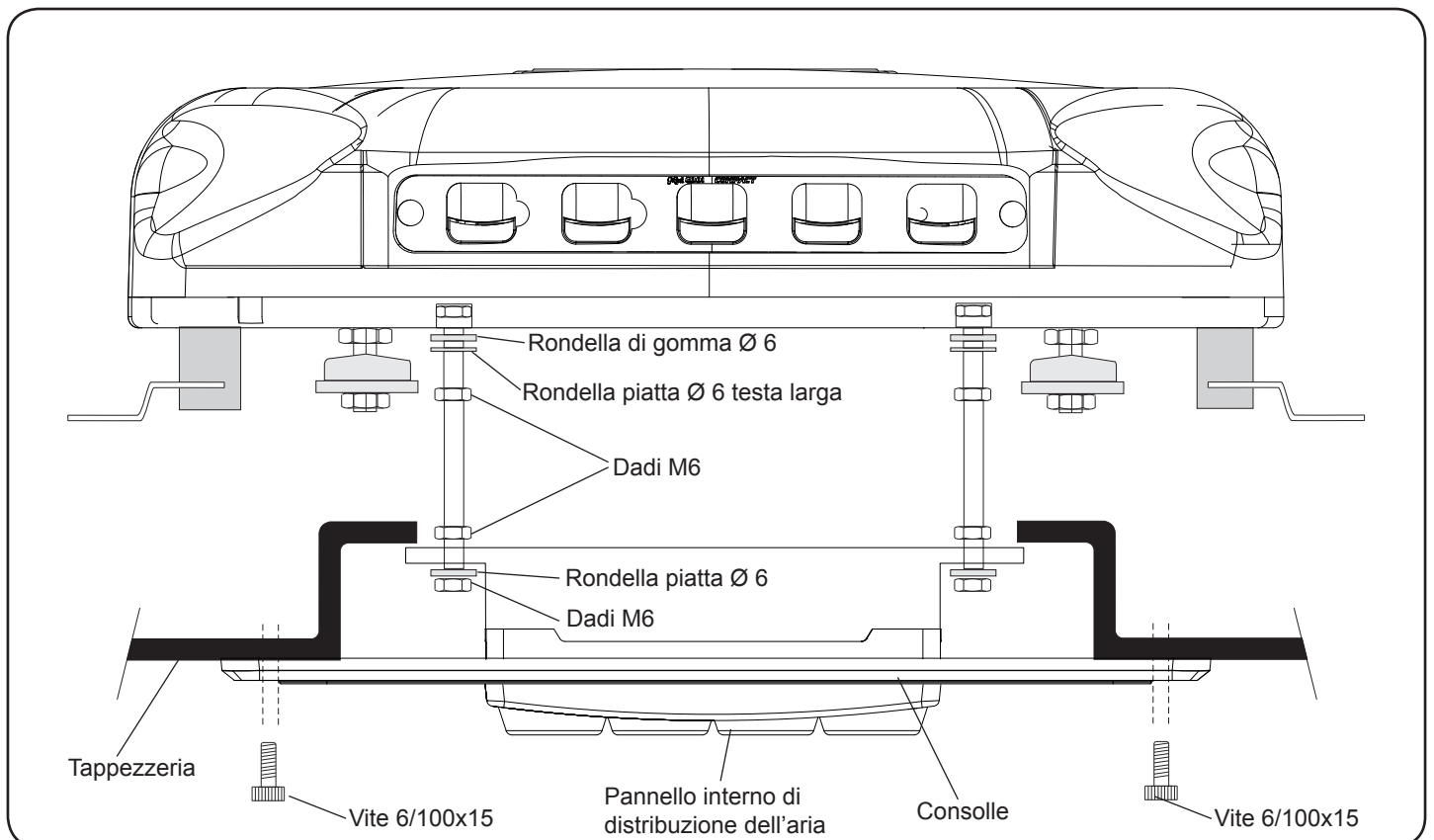

## Istruzioni dettagliate Sull'installazione del cablaggio di alimentazione



1- Portare il cavo di alimentazione dell'apparecchio fino alla batteria del veicolo, incollando i supporti di plastica nella parte posteriore della cabina e fissandolo con flange; successivamente, con la cabina abbassata, passare il cavo per la parte inferiore della stessa fissandolo con morsetti e viti M4 e far passare fino alla batteria con flange, usando lo stesso passo del cablaggio originale. *(Per incollare i supporti di plastica pulire bene la zona prima di procedere)* Quando si collega l'apparecchio alla batteria, verrà eseguito un test su tutti i led e sul display verrà visualizzata la scritta **88--bd** e si spegnerà.

**Importante:** A causa del complesso sistema di regolazione elettronica dell'apparecchio, la presa di corrente deve essere ubicata direttamente nella batteria del veicolo e non in qualsiasi altro punto che alimenti altri accessori del veicolo, facendo attenzione a non invertire la polarità quando si esegue il collegamento dell'impianto alla batteria. Infatti, in tal caso il quadro comandi non si accende e l'impianto non funziona (2).

**Importante:** Per l'accensione consultare il Manuale dell'Utente.

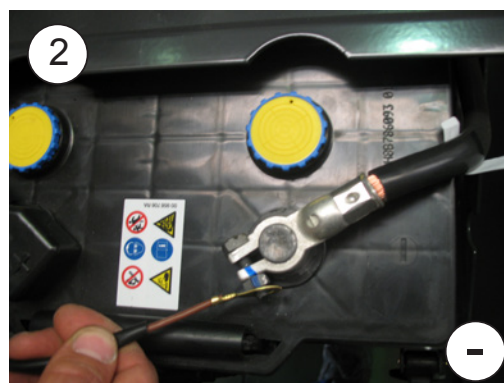
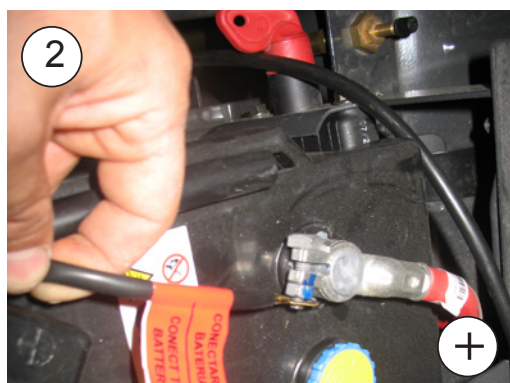

Cablaggio elettrico

AVVISO IMPORTANTE!

**Fare attenzione** a non invertire le polarità quando si esegue il collegamento dell'impianto alla batteria. Infatti, in tal caso il quadro comandi non si accende e l'impianto non funziona.

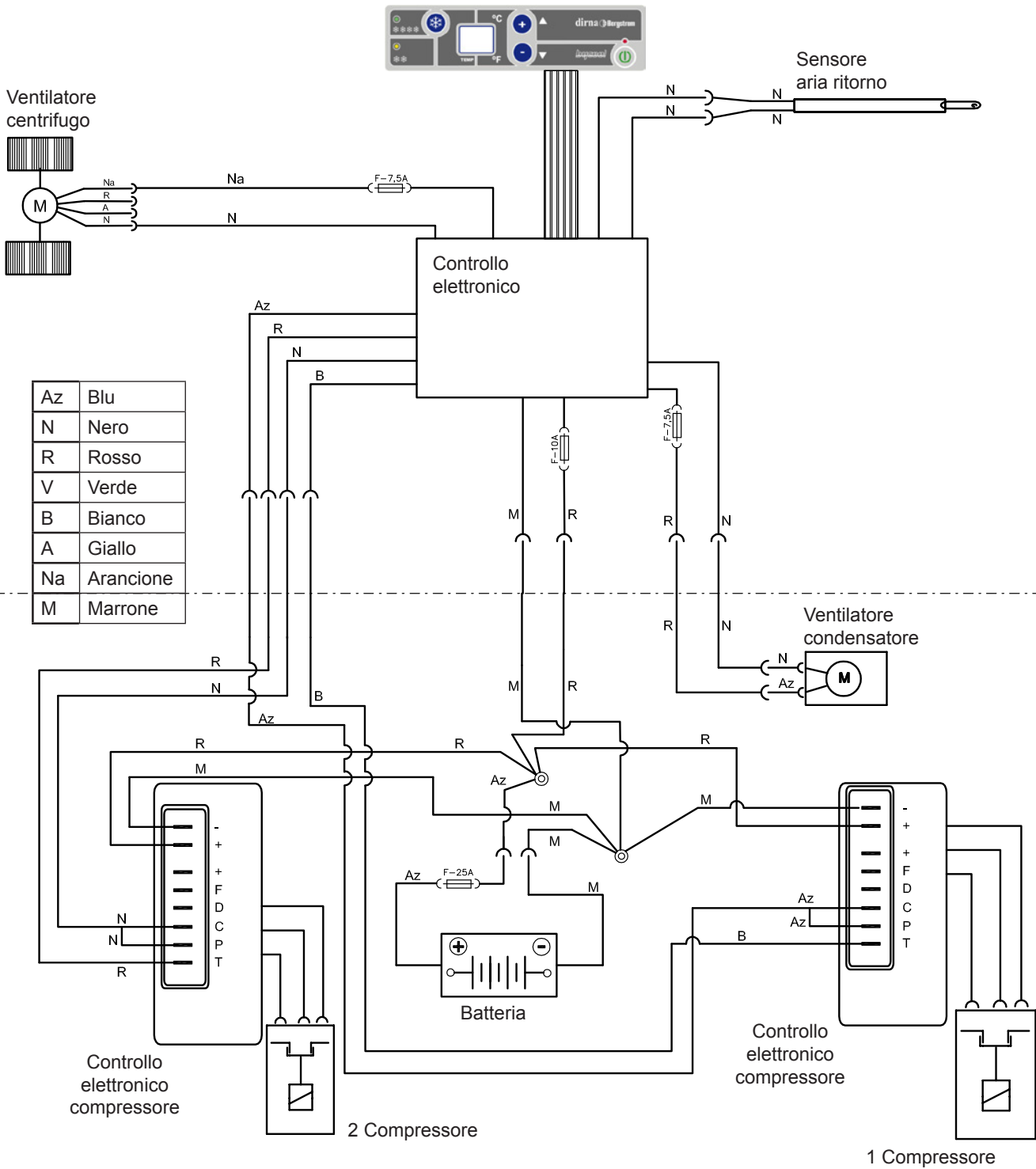

Ed:	14/01/2016
Md:	25/07/2019





b

**dirna**  **Bergstrom.**

Francisco Alonso, 6  
28806 Alcalá de Henares, Madrid  
SPAIN

Contact	Phone	Fax	E-Mail
Sales (Ventas Internacional)	+34 91 8770510	+34 91 8771158	sales@dirna.bergstrominc.com
Comercial Nacional	+34 91 8775841	+34 91 8836321	ventas@dirna.bergstrominc.com
Orders & Deliveries (Logística internacional)	+34 91 8775846	+34 91 8771158	export@dirna.bergstrominc.com
Orders & Deliveries (Logística nacional)	+34 91 8775840	+34 91 8836321	comercial@dirna.bergstrominc.com
Technical Assistance (Internacional)	+49 511 86679681	+49 511 86679710	technicalassistance@dirna.bergstrominc.com
Technical Assistance (Nacional)	+34 91 8775845	+34 91 883 6321	oblanco@dirna.bergstrominc.com

[www.dirna.com](http://www.dirna.com)

	<b>ATENCIÓN:</b>	Dirna Bergstrom se reserva el derecho de efectuar modificaciones en cualquier momento de los datos contenidos en esta publicación, por razones técnicas o comerciales.
	<b>NOTE:</b>	<i>For technical and commercial reasons, Dirna Bergstrom reserves the right to change the data contained in this brochure.</i>
	<b>ATTENTION:</b>	Dirna Bergstrom se réserve le droit d'effectuer à tout moment des modifications des données reprises sur cette publication, pour des raisons techniques ou commerciales.
	<b>HIWEIS:</b>	<i>Dirna Bergstrom behält sich vor, aus technischen oder kaufmännischen Gründen jederzeit Änderungen der Angaben dieser Veröffentlichung vorzunehmen.</i>
	<b>ATTENZIONE:</b>	Dirna Bergstrom si riserva il diritto di effettuare modifiche in qualsiasi momento ai dati contenuti in questa pubblicazione, per motivi tecnici o commerciali.