

biycool!
green line

SLIM FIT

RENAULT T High sleeper cab



Instrucciones de Montaje

Mounting Instructions

Instructions de Montage

Montageanweisungen

Istruzioni di Montaggio

ES Spanish

EN English

FR French

GE German

IT Italian

Recomendaciones Para el montaje

- Antes de iniciar el montaje leer las instrucciones y seguirlas durante el proceso de instalación.
- Usar las herramientas adecuadas para cada operación.

Electricidad

- Desconectar la llave de contacto.
- Desconectar la batería antes de empezar el montaje.
- Asegurar el conexionado de los componentes eléctricos, verificando su correcto encaje.

Atención

Si durante el montaje el equipo se inclina o se abate la cabina con el equipo montado, se deberá esperar un mínimo de 60 minutos, desde que el equipo quede horizontal, antes de ponerlo en marcha.

Atención

Al instalar el equipo de aire acondicionado en el techo se debe proteger la parte superior de la cabina con un paño o manta protectora para evitar posibles arañazos. Al instalar **Slim Fit** en el techo hay que tener en cuenta que, normalmente, las cabinas que vienen provistas de escotilla, tienen una estructura suficiente para soportar el peso del equipo. Sin embargo, cuando no ocurra así y sea necesario realizar corte en el techo o incluso si en el caso de llevar escotilla el material no es lo suficientemente resistente (caso de techo de fibra, plástico, etc...) es el instalador el que debe decidir, **bajo su responsabilidad**, sobre la necesidad de reforzar el techo para evitar posibles deformaciones, roturas, entradas de agua, etc... habilitando los medios para que esto no ocurra.

Herramientas

Juego de Llaves Torx

Juego de Llaves Allen

Llave fija 10, 13, 14

Tijeras

Flexómetro

Documentación incluida

Instrucciones de montaje	1000977876
Manual del usuario	220AA35378
Diagnosis de averías	220AA35379
Garantía	220AA10017

Simbología



Fragil





Atención corte!



Riesgo eléctrico

Advertencias

 El personal instalador debe poseer una formación suficiente en Aire Acondicionado de vehículos.

 **dirna Bergstrom, s.l.** queda exenta de responsabilidad si se producen averías que procedan de una inadecuada manipulación o instalación del equipo, o por modificaciones y sustituciones efectuadas sin nuestra expresa autorización por escrito.

 **Equipo precargado con gas** refrigerante R-134a. **(No manipular el circuito de gas refrigerante).**

 Véase **procedimiento de garantía** del producto incluido en **Diagnosis de Averías**.

 Véase **Manual de Usuario** del equipo para el correcto funcionamiento del mando a distancia y del panel de control.

 Al finalizar la instalación se debe entregar al usuario: **Manual del Usuario, Garantía y Diagnosis de averías.**



Las modificaciones a realizar en el spoiler deben ser autorizadas por el cliente. Por lo que dirna Bergstrom se exime de toda responsabilidad por la modificación del spoiler.

1

Desmontar consola original, tirando del externo de las luces para acceder a los tornillos de fijación.
En el caso de llevar leds (*) desmontar tirando de ellos.



2

Desmontar escotilla quitando tornillos de fijación de la misma (en escotilla eléctrica desconectar clema (*) de la misma).

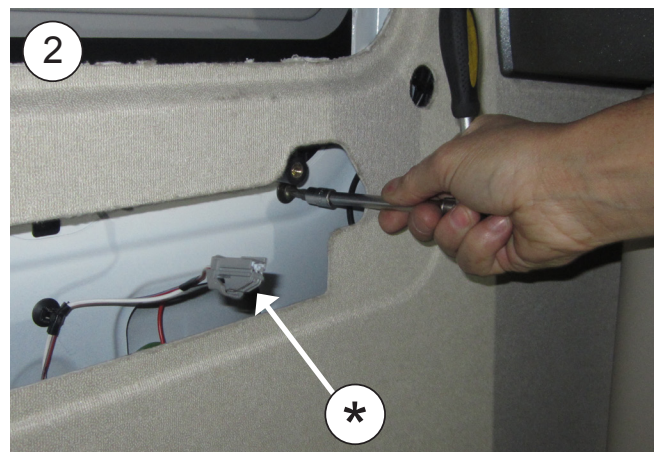

3

Limpiar contorno escotilla y pegar junta EPDM 30x25, por el exterior del resalte del contorno del hueco de la escotilla.



4

COMO CORTAR LA JUNTA EPDM PARA EVITAR FILTRACIÓN DE AGUA EN LA CABINA

- A- Pegar la junta, manteniendo 100 mm de papel protector por cada lado.
- B- Quitar los dos piezas de papel.
- C- Pegue presionado ambos finales.

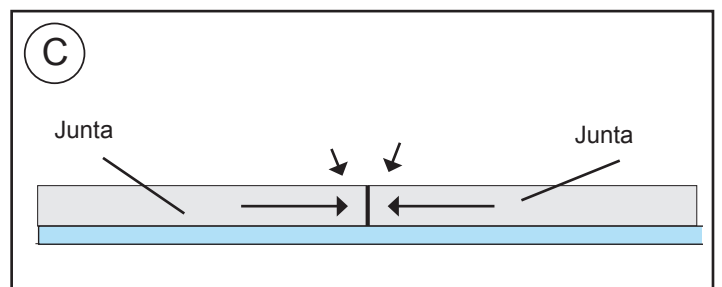
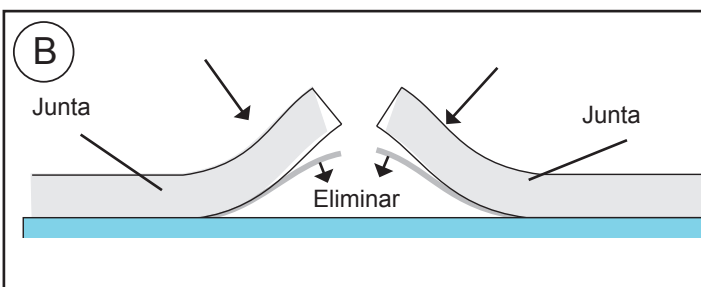
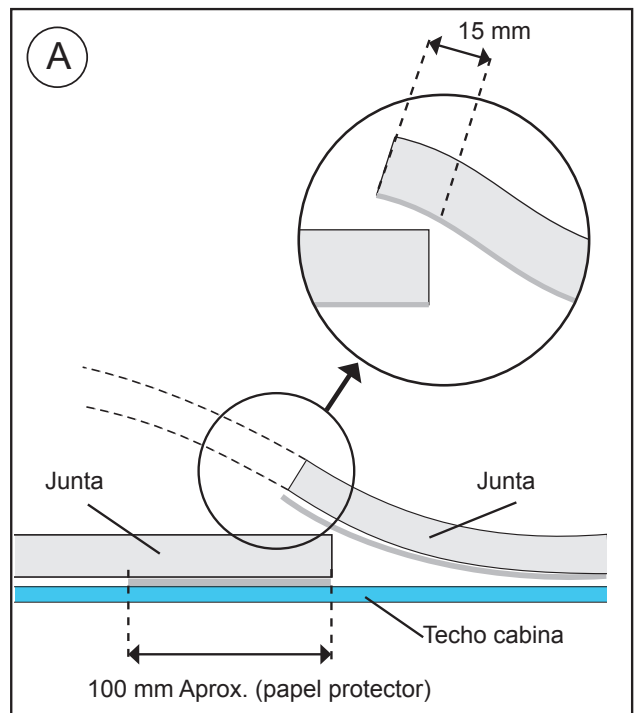

5 Introducir una arandela plana $\varnothing 8$ ala ancha y una arandela de goma $\varnothing 20 \times \varnothing 7 \times 3$ en cada hexágono M8.



Hexágono
Arandela plana
Arandela goma

6 Poner equipo en posición vertical y roscar hexágonos en insertos, respetando posición indicada, apretar con par de apriete $12,7 \pm 10\%$ Nm.



hexágono L=22
hexágono L=17

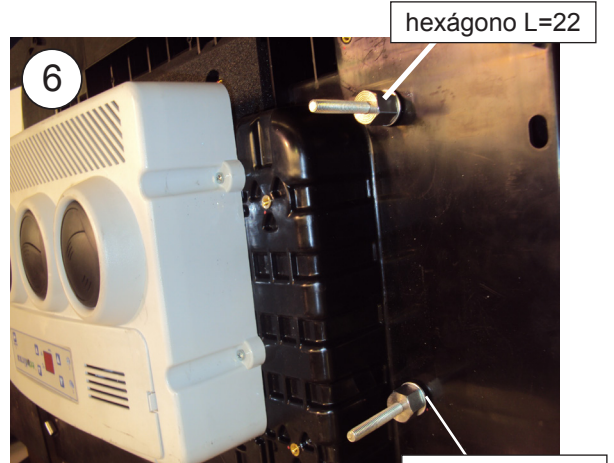

hexágono L=22
hexágono L=17

7 Roscar (4) centradores en soportes centradores respetando posición indicada.

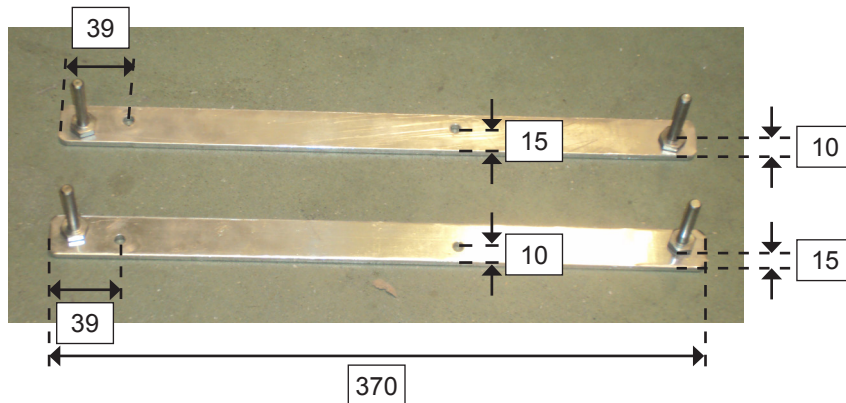

8 Montar centradores en la base con (4) tornillos 200TX40016 4x16, respetando posición indicada con par de apriete 4,75x10% Nm.

Parte delantera de equipo

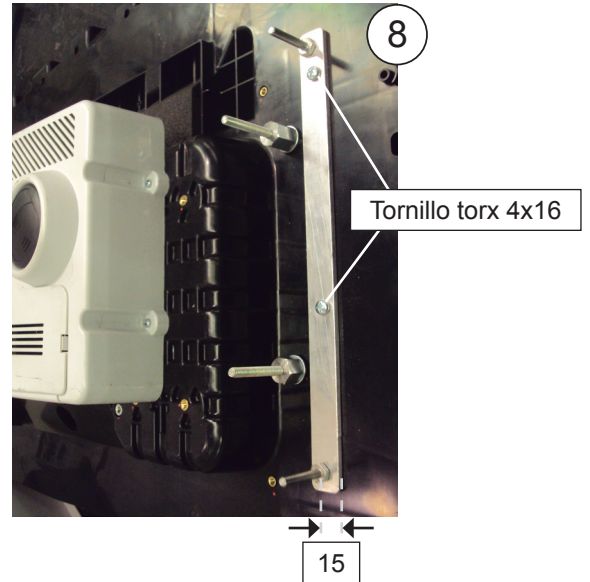
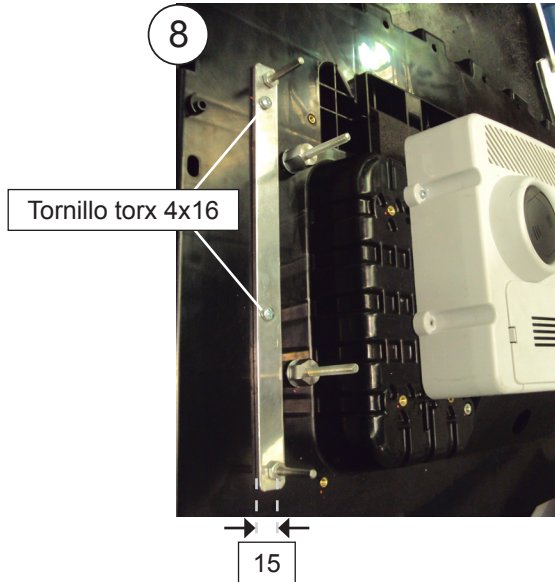

9 Posicionar equipo sobre hueco escotilla, introduciendo las guías en taladros de la cabina.

Atención: Si el equipo queda pegando en spoiler, marcar y efectuar corte en éste para librarlo (siempre bajo autorización del cliente).

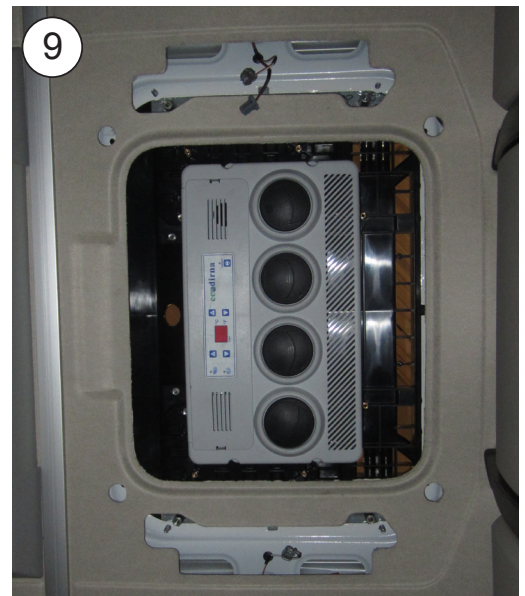
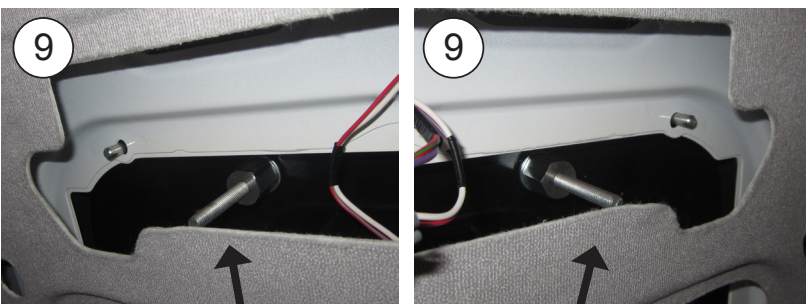

10 Introducir soportes en espárragos M8, por debajo del tapizado.

Atención: es muy importante quitar las grapas de sujeción del cableado de escotilla, para que los soportes no aplasten los cables.

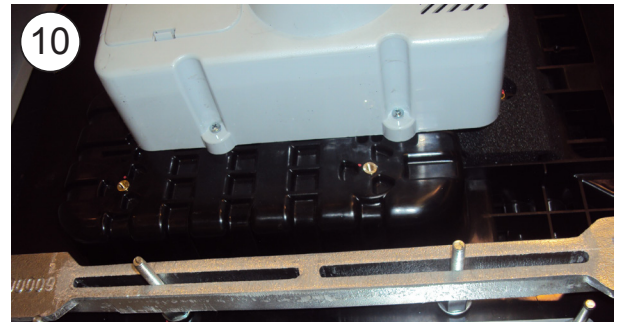
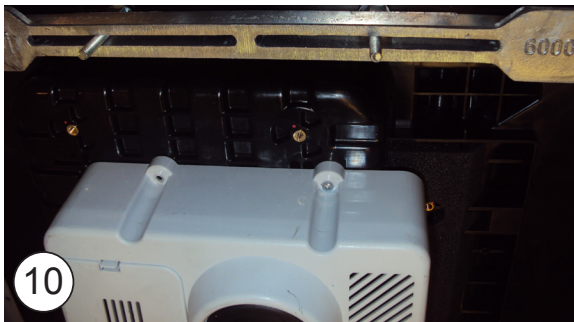

11 Montar hexágonos M6 en soportes respetando posición indicada y apretando con par de apriete.

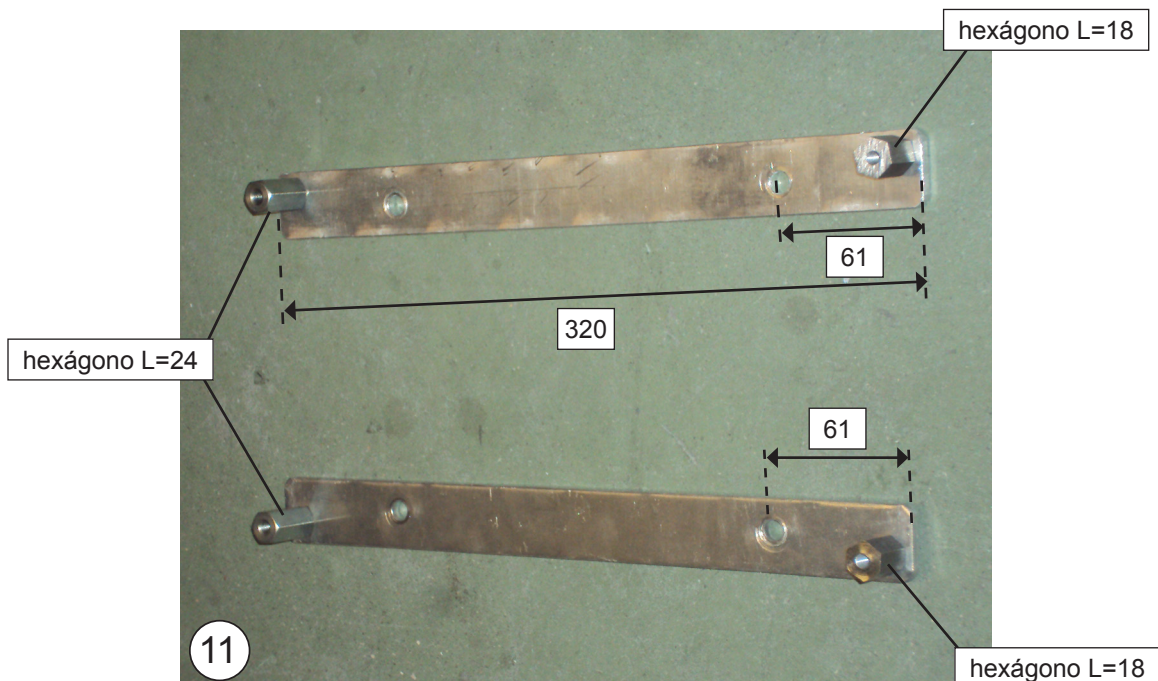

12

Introducir soportes con hexágonos, en insertos M8, sobre los soportes de fijación. Los hexágonos deben quedar: en el exterior de los espárragos y quedando los de L=24 en la parte trasera de la cabina y los de 18 en la parte delantera.

Vista lado izquierdo cabina

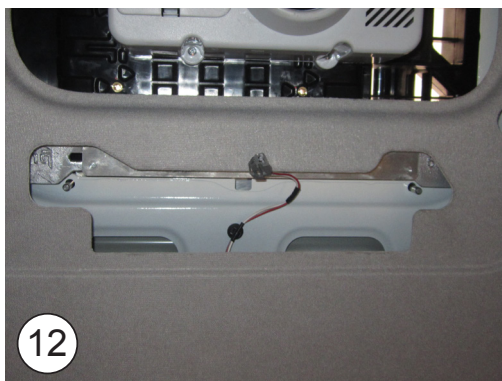

Vista lado derecho cabina

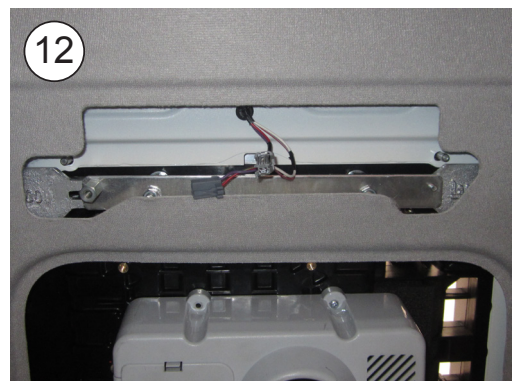
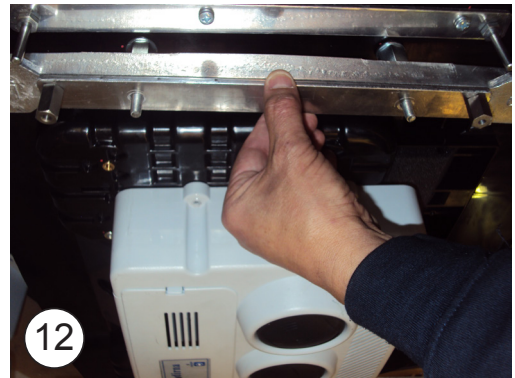

13

Introducir una arandela plana Ø 8 y una tuerca M8 autoblocante en cada espárrago.

Vista lado izquierdo cabina



Vista lado derecho cabina



14

Verificar que los soportes hacen correctamente apoyo tanto en parte delantera como trasera y que no hay cables que se puedan aplastar. Apretar tuercas M8 hasta que los soportes hagan tope con los hexágonos de la base.

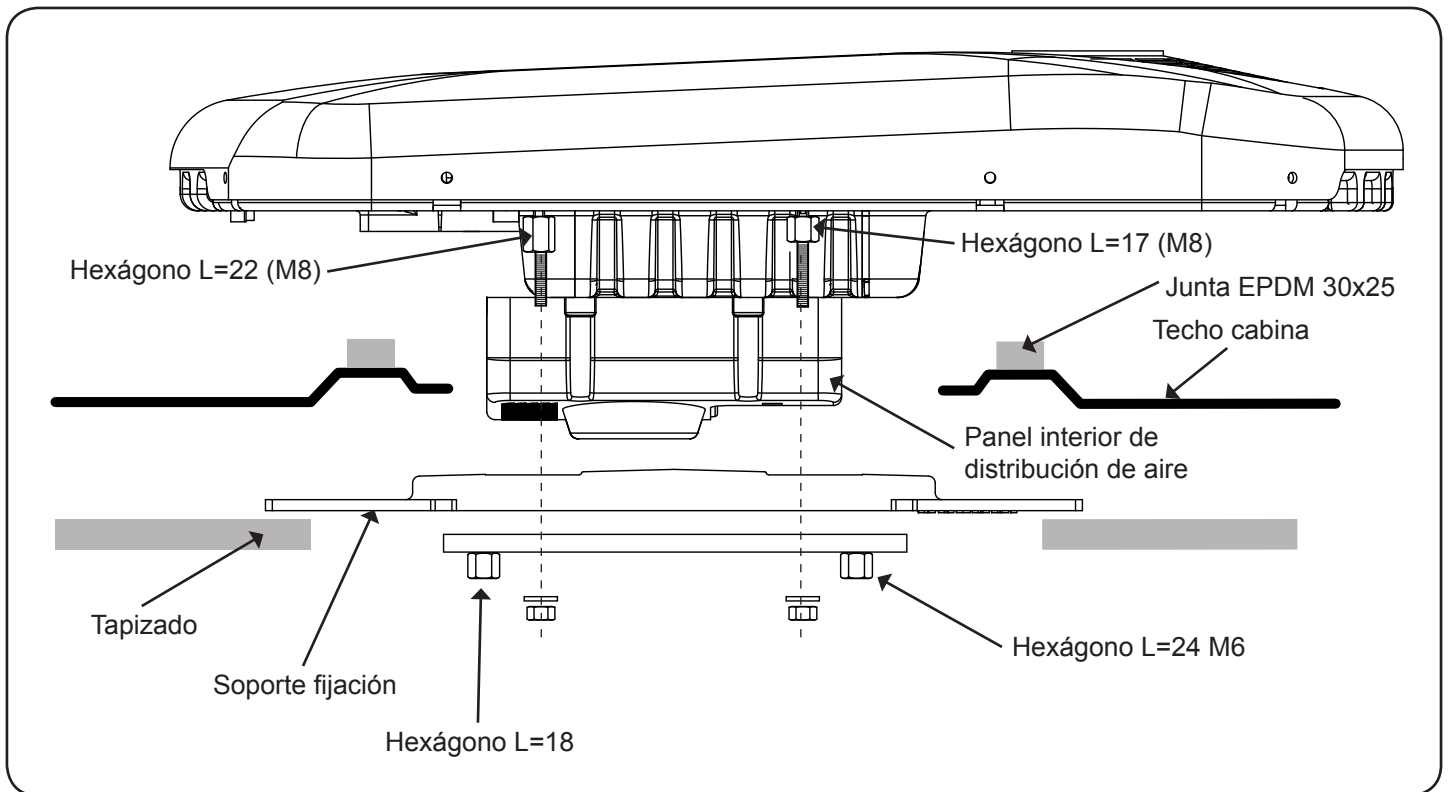
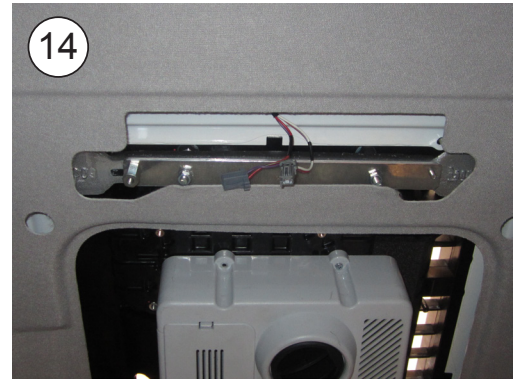
**15**

Posicionar consola sobre el panel interior de distribución de aire y fijar con (4) tornillo 6/100x10 cabeza phillips y con (4) arandelas planas Ø 6 ala ancha roscando en hexágonos.

16 Conectar luces originales e introducir las en la consola presionando sobre ellas.



17 Conectar cableado de alimentación con equipo, fijar clemas de conexión al techo con soportes con adhesivo y bridas de plástico.

Atención: limpiar bien la zona antes de pegar los soportes con adhesivo.

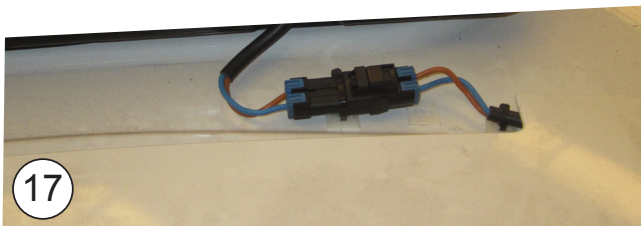
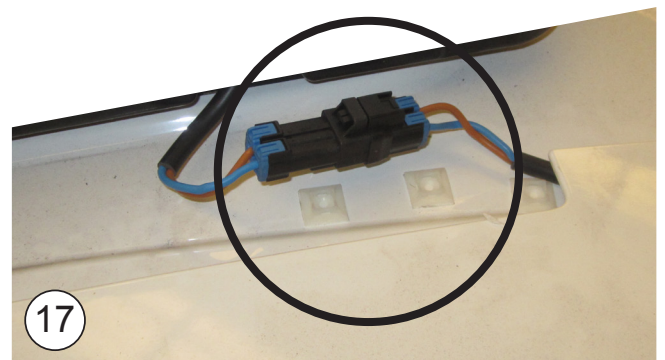

18 Aflojar soportes de spoiler, lado derecho, y pasar cableado por debajo de ellos, pegado a la esquina de la cabina y dejar soportes spoiler en posición original.



19

Fijar cableado bajo el spoiler con soportes con adhesivo y bridas de plástico.

Atención: limpiar bien la zona antes de pegar los soportes con adhesivo.



20

Sujetar cableado con soportes con adhesivo y bridas a cabina, soporte spoiler lateral y cableado original.

Atención: limpiar bien la zona antes de pegar los soportes con adhesivo.



21 Abatir cabina y pasar cableado por debajo de protector (*) hacia la parte delantera de la cabina, fijándole con bridas a cable original.

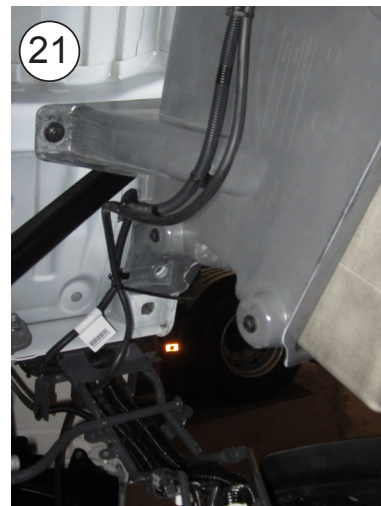
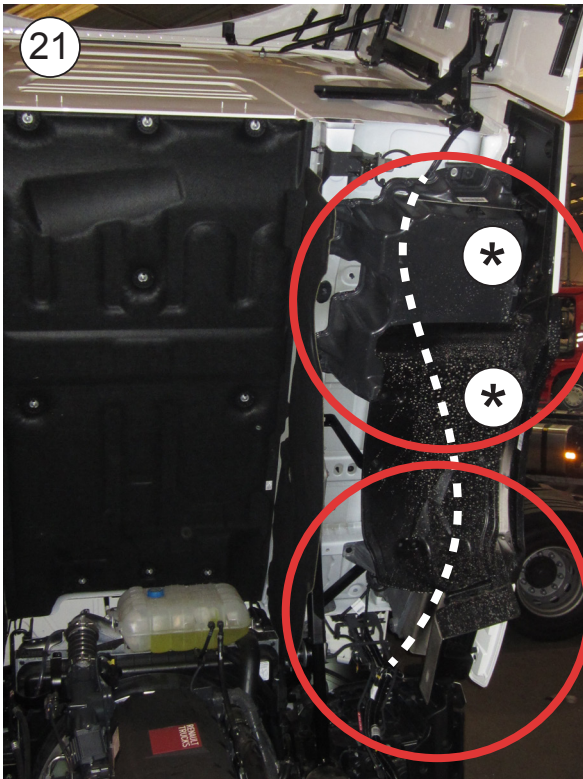

22 Dejar cabina en posición marcha y desmontar tapas de conexiones y paso de cableados originales (*).

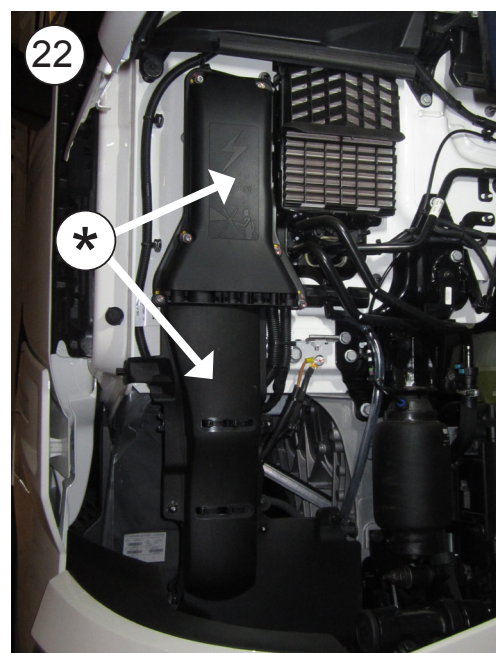

23

Conectar cableado a tomas originales de (+) y (-) pasándolo con cableados originales. Fijar fusible con brida de plástico a cableado original.

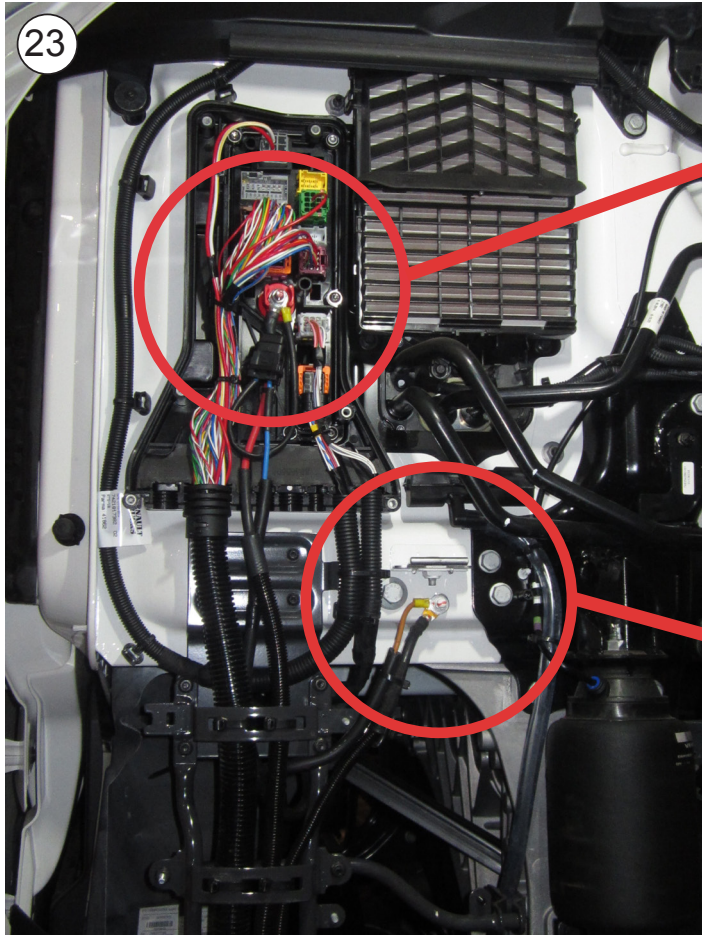
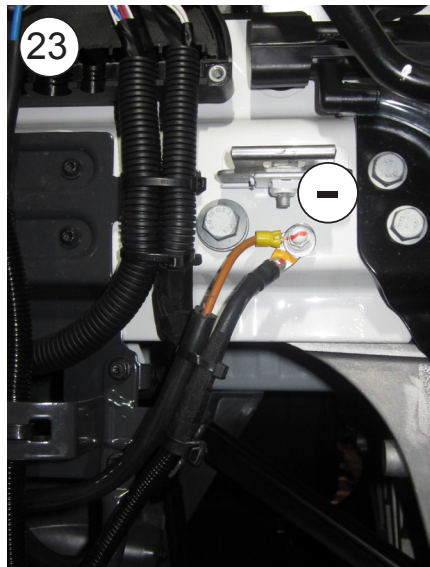
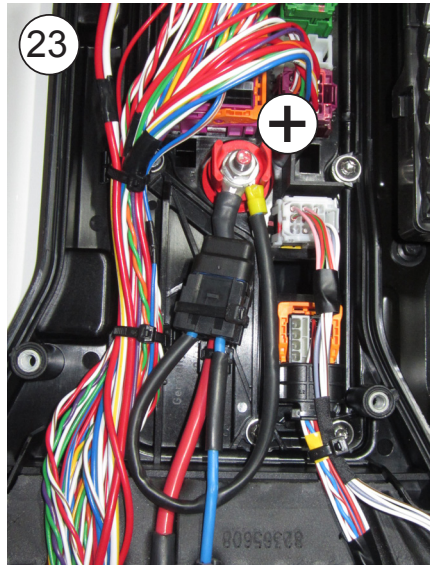

Atención antes de poner el equipo en funcionamiento hay que esperar al menos una hora después de dejar la cabina en posición de marcha.

Esquema eléctrico

¡AVISO IMPORTANTE!

Precaución de no invertir las polaridades al conectar el equipo a la batería. Si esto sucediera la placa no se enciende y el equipo no funciona.

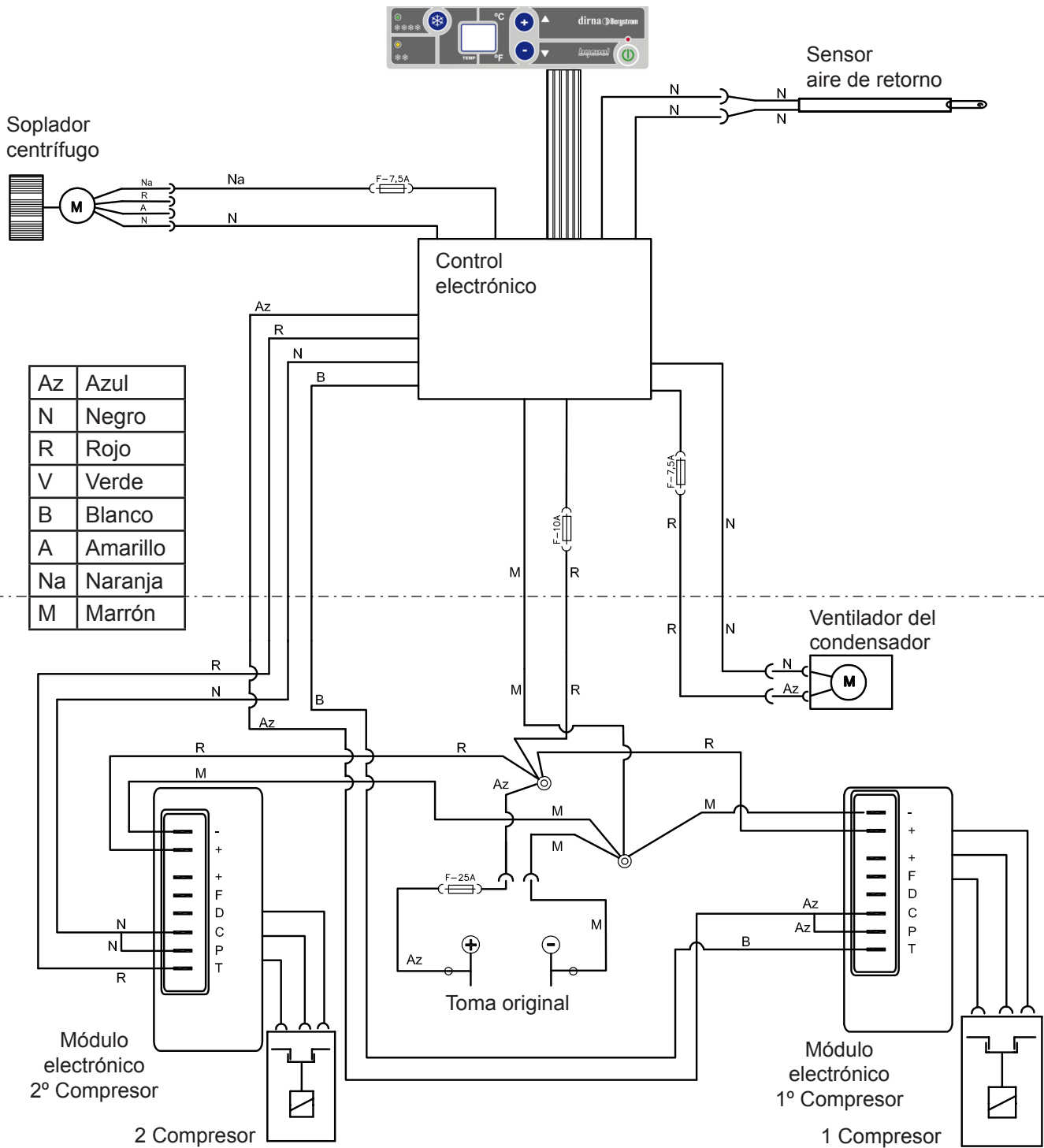

Assembly Recommendations

- Before starting assembly, please read instructions and follow them during installation process.
- Use the adequate tools for each operation.

Electricity

- Disconnect ignition key.
- Disconnect battery before starting assembly.
- Make sure electric components are securely connected, checking their correct fitting.

Warning

If the unit slants during assembly, wait for at least 60 minutes with the unit in horizontal position before starting it up.

Warning

When installing air conditioning equipment on roof, the upper cabin part must be protected with a cloth or a protective blanket to avoid possible scratches. When installing **Compact** on roof, take into account that, normally, cabins equipped with a hatch have a strong enough structure to hold equipment weight. However, if it is not the case and it is necessary to carry out a cut in the roof or, although it has a hatch, the material is not resistant enough (*if roof is made of fibre, plastic, etc...*), it is the installer who will have to decide, under his responsibility, if it is necessary to reinforce the roof to avoid possible deformations, breaks, water entries, etc., habilitating the means required to stop it from occurring.

Tools

Torx wrenches set
 Allen wrenches set
 Open-jawed spanner 10, 13, 14
 Scissors
 Flexo-meter

Documentation included

Mounting instructions	1000977876
User's guide	220AA35378
Troubleshooting	220AA35379
Warranty	220AA10017

Symbology



Fragile









Beware of cuts!



Electrical hazard

Warnings

-  The installing personnel must have a sufficient training in vehicles air conditioning.
-  **dirna Bergstrom, s.l.** shall not be responsible for breakdowns or damages coming from an inadequate handling or installation of the equipment or from modifications and substitutions carried out without our express and written authorisation.
-  **Equipment pre-charged with refrigerating gas, R-134a. (Do not handle refrigerating gas circuit).**
-  Please see product **warranty procedure** included in **Troubleshooting diagnosis**.
-  Please see equipment **User's Guide** for its correct functioning of the remote control and control panel.
-  Once installation is finished, the following documents must be handed over to the user: **User's Guide, Warranty and Troubleshooting Diagnosis**.

 Any changes made to the spoiler must be authorised by the customer. In consequence, dirna Bergstrom shall be released from any liability deriving from modification of the spoiler.

1 Take down the original console, pulling on the end of the lights to access the fastening screws.
If LEDs are fitted (*), pull on them to remove.



2 Take down the hatch by removing the fastening screws (disconnect wire clamp (*) in electrical hatch).

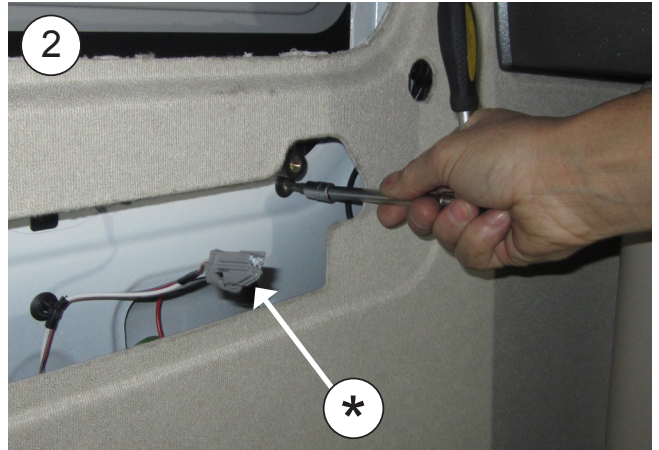

3 Clean the hatch surround and attach 30x25 EPDM seal on the outside of the ridge of the hatch gap.



4 **HOW TO CUT EPDM GASKET TO AVOID WATER FILTRATION INTO THE CABIN**

A- Glue gasket, keeping 100 mm of protection paper at each side.

B- Remove the two pieces of paper.

C- Glue by pressing both ends.

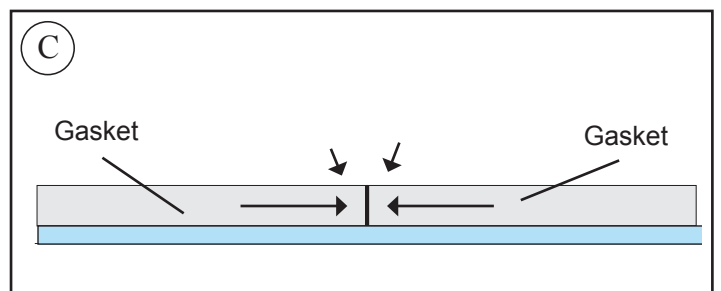
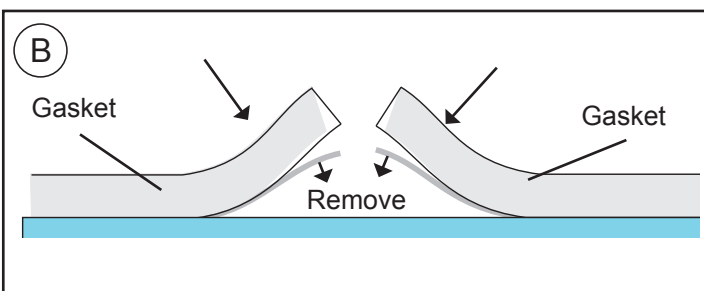
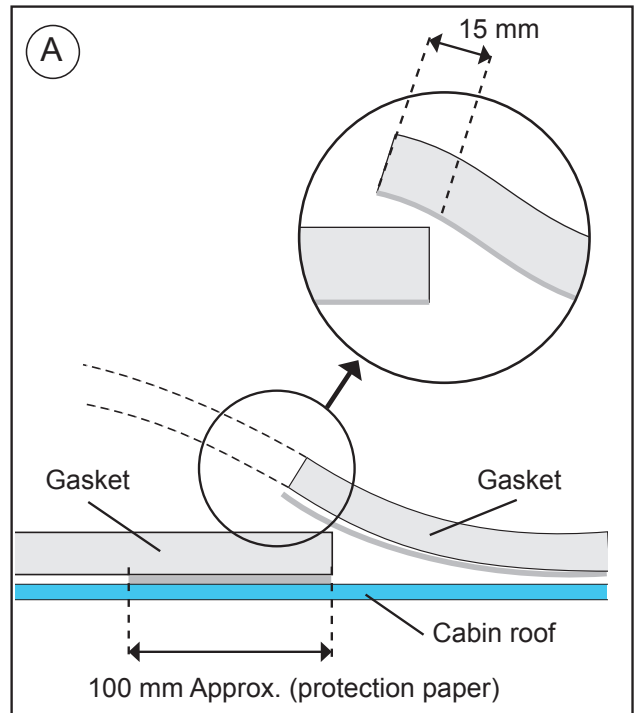

5 Introduce an Ø8 wide-rimmed flat washer and Ø20 x Ø7 x 3 rubber washer.

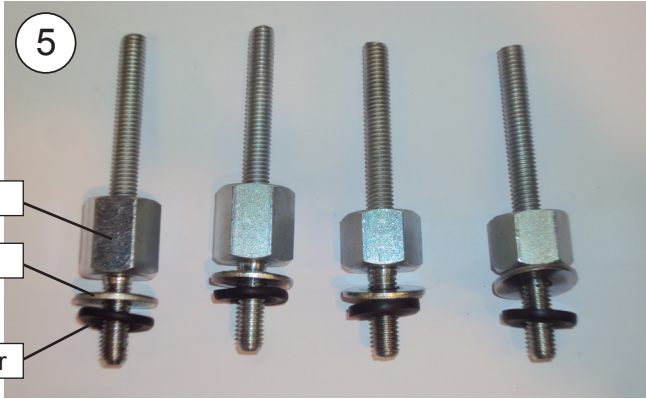

6 Place the unit in vertical position and screw hexagons in the inserts, respecting the indicated position, and tighten with a torque of 12.7±10% Nm.

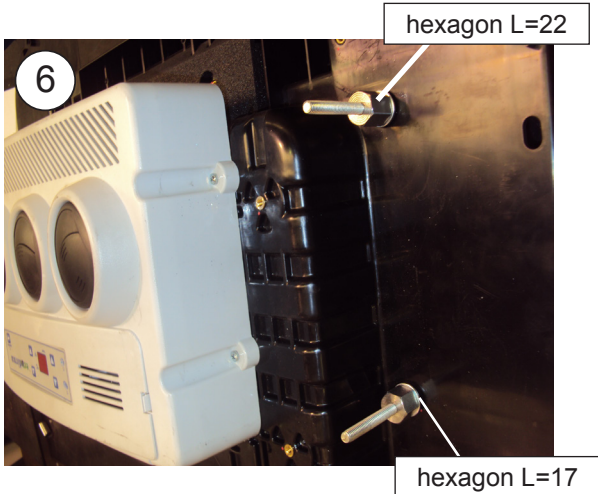
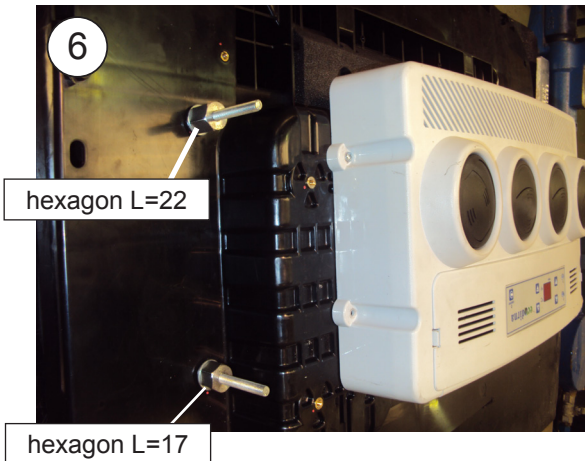

7 Screw (4) aligners on the aligner mounts, respecting the indicated position.

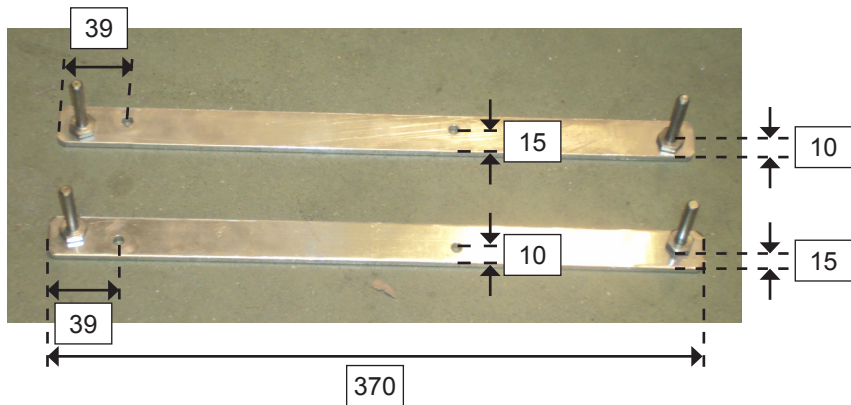

8 Assemble the aligners on the base with (4) 4x16 screws (200TX40016), respecting the indicated position, with tightening torque 4.75x10% Nm.

Front part of unit

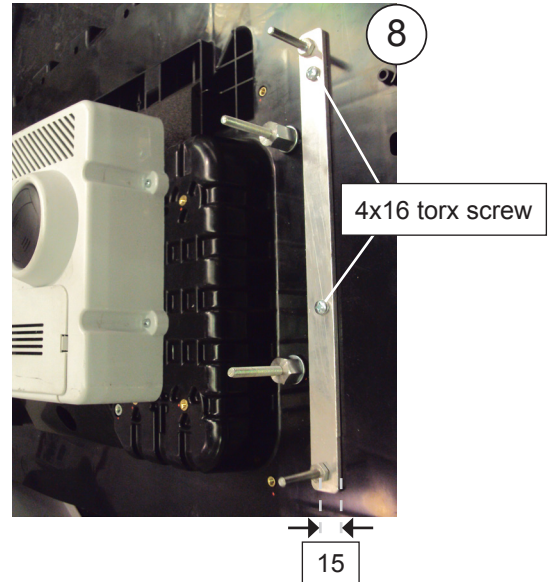
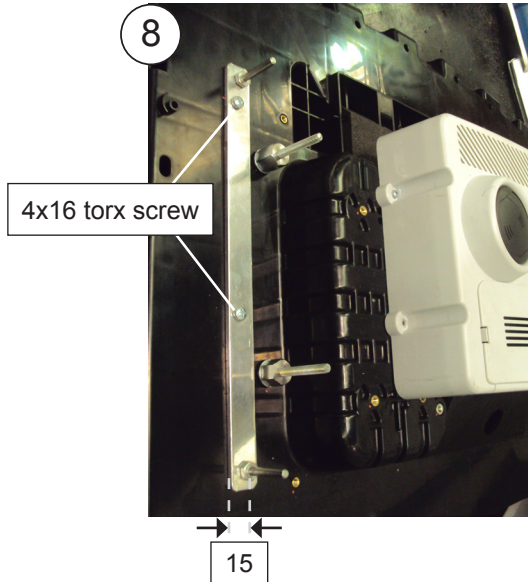

9 Position the unit on the hatch gap, introducing the guides in the boreholes (always with authorisation from the client) of the cabin.

Caution: If the unit is stuck in the spoiler, release it by marking and making a cut.

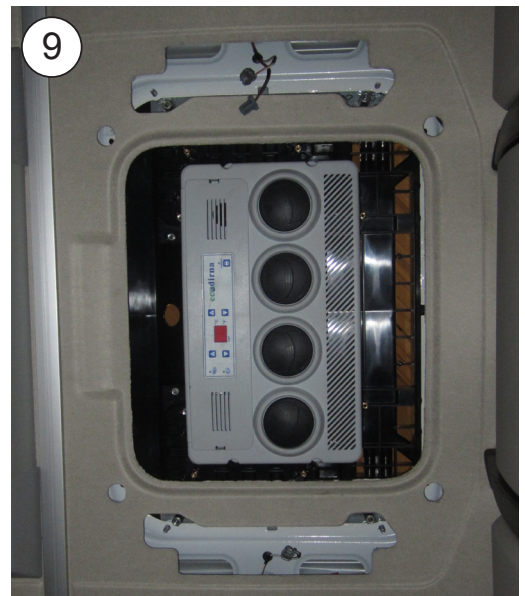
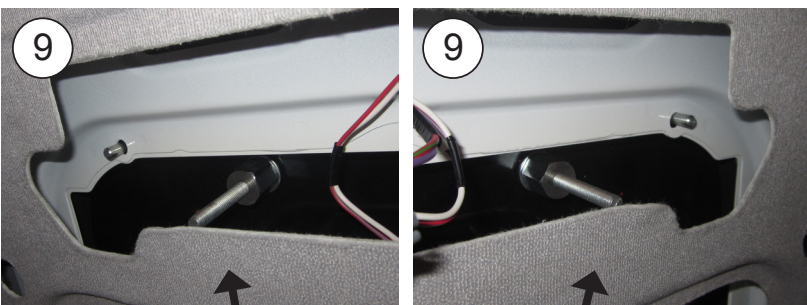

10 Introduce the mounts on M8 studs underneath the upholstery.

Caution: It is very important to remove the hatch wiring clamps to ensure the wiring is not crushed by the mounts.

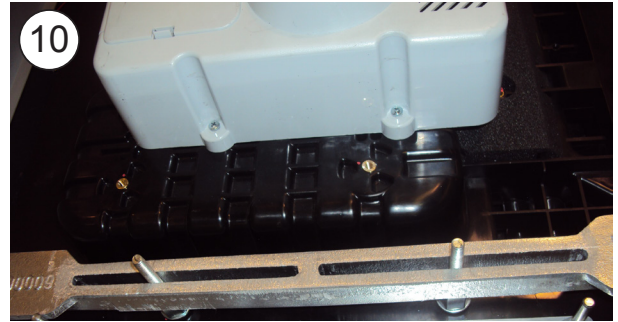
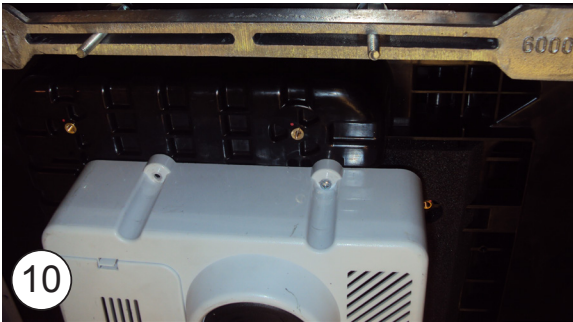
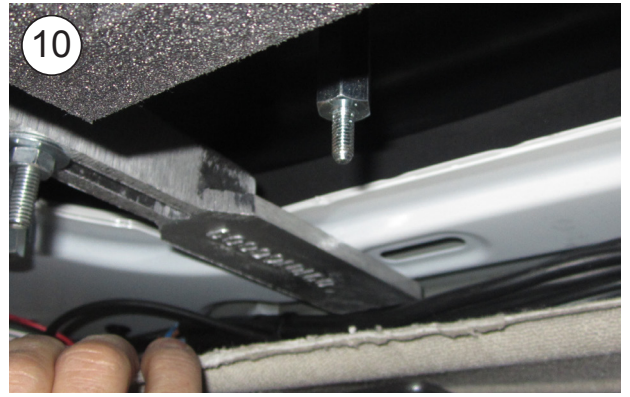

11 Mount M6 hexagons on the mounts, respecting the indicated position and tightening torque.

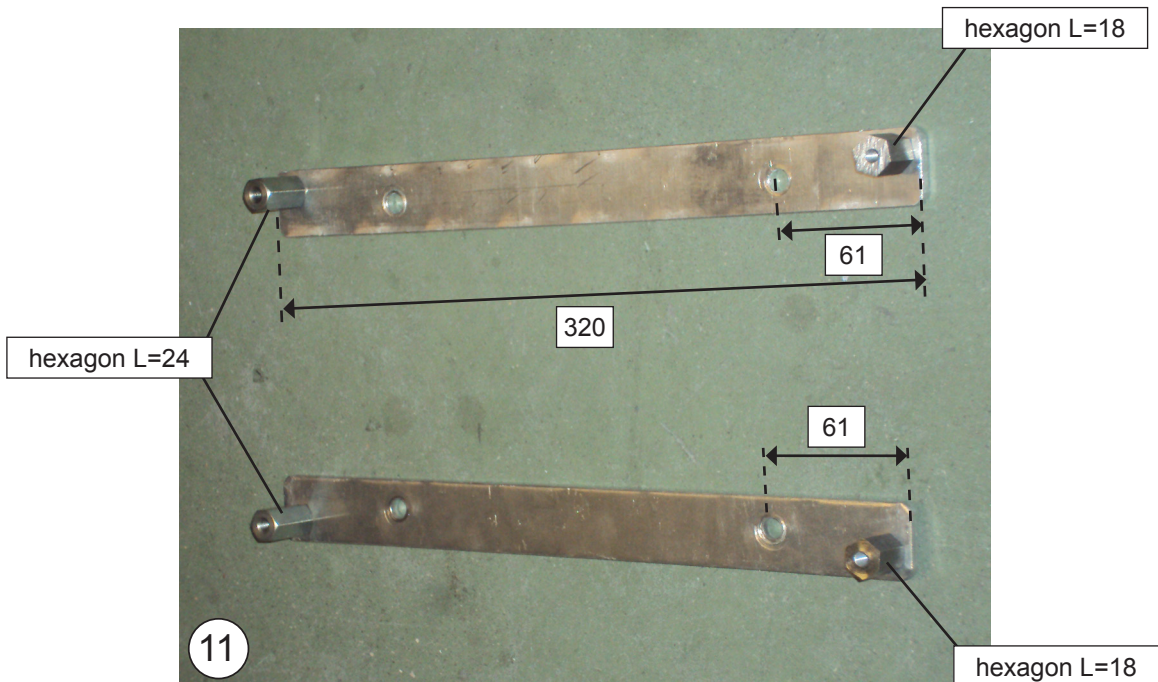

12 Introduce the mounts with hexagons in M8 inserts on the fastening mounts. The hexagons must be: outside the studs, with those of the L=24 remaining at the back of the cabin and those of the L=18 at the front.

Cabin left side view

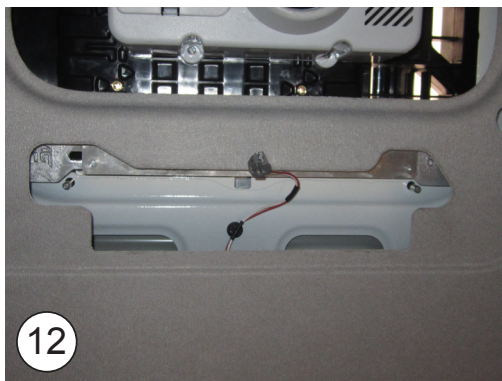
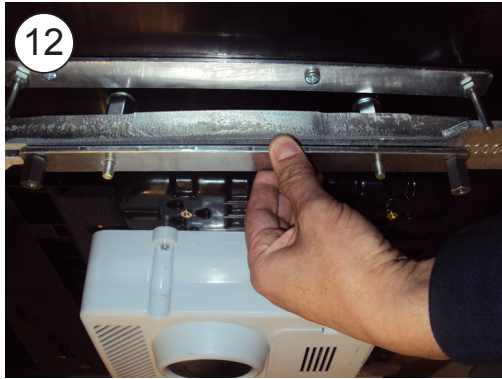

Cabin right side view

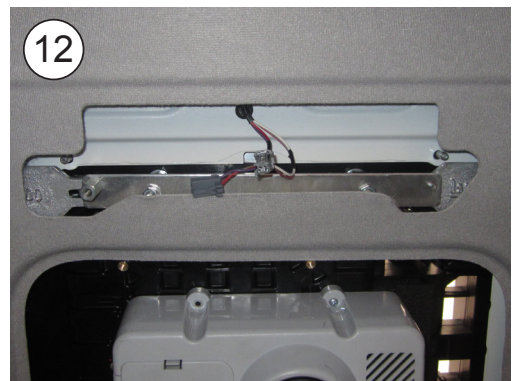
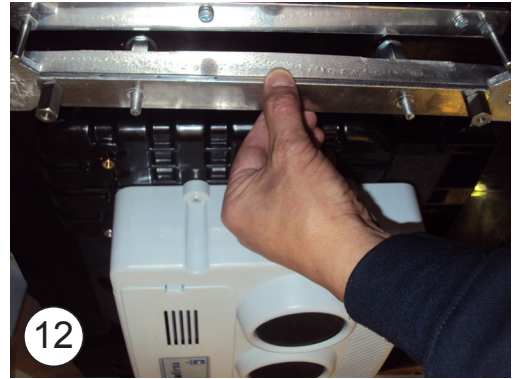

13 Introduce an Ø8 flat washer and a self-locking M8 nut on each stud.

Cabin left side view



Cabin right side view



14

Check that the mounts are properly supported in the front and back and that there is no wiring which can be crushed. Tighten the M8 nuts until the mounts come up against the base hexagons.

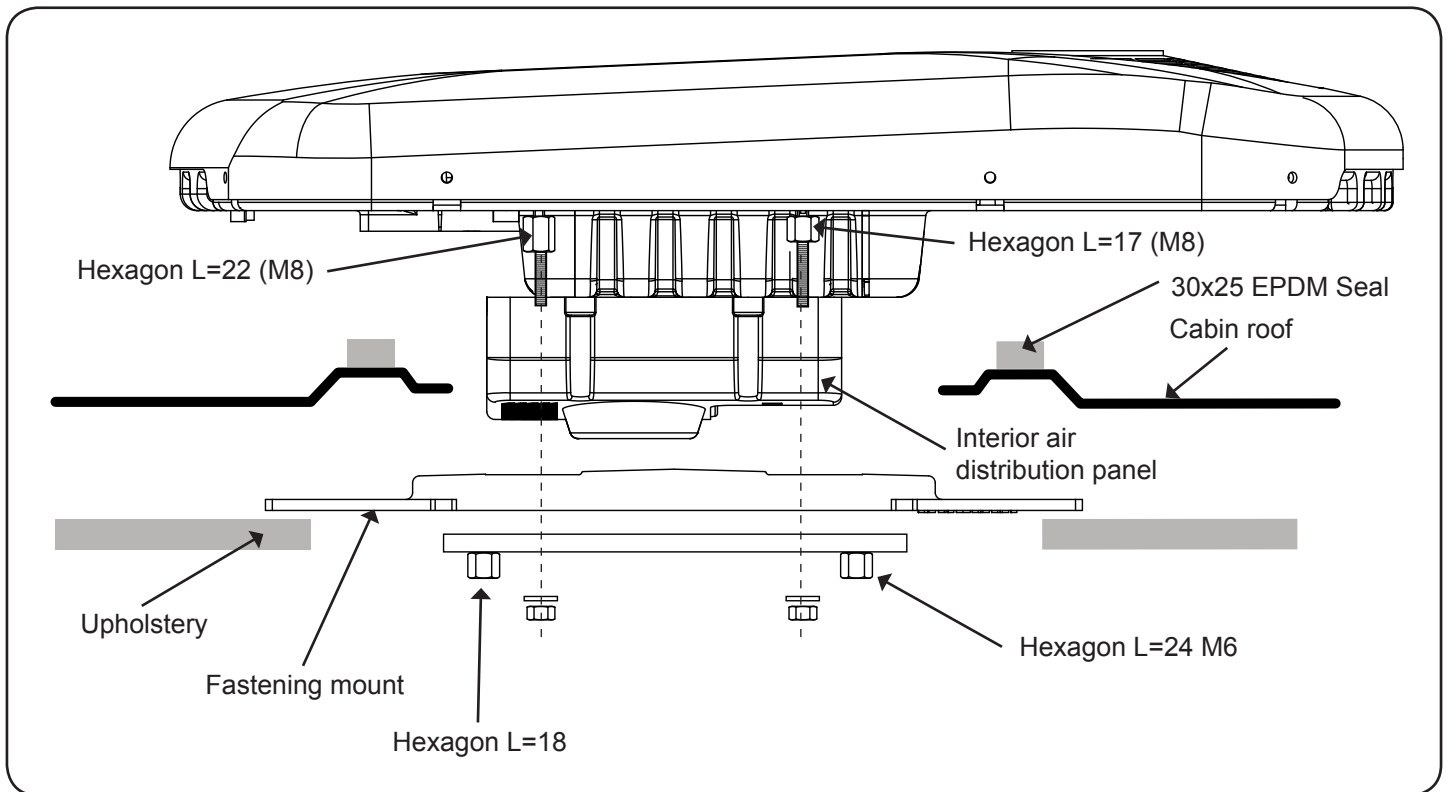
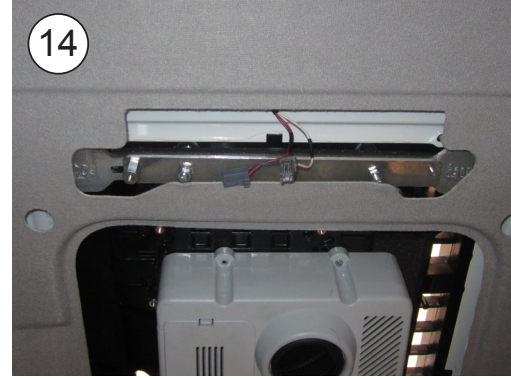

15

Position the console on the interior air distribution panel and secure with (4) 6/100x10 Phillips head screws and (4) Ø6 wide-rimmed flat washers on hexagons.

16

Connect the original lights and introduce them in the console by pressing on them.



17

Connect the power cable to the unit, secure the connection wire clamps to the roof with mounts with adhesive and plastic flanges.

Caution: clean the area thoroughly before attaching the mounts with adhesive.

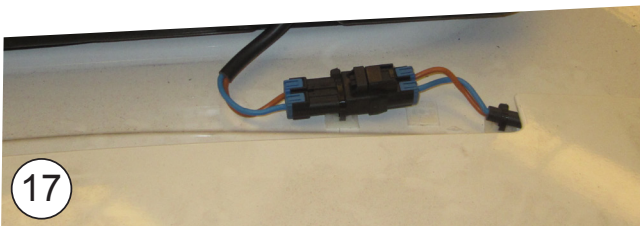
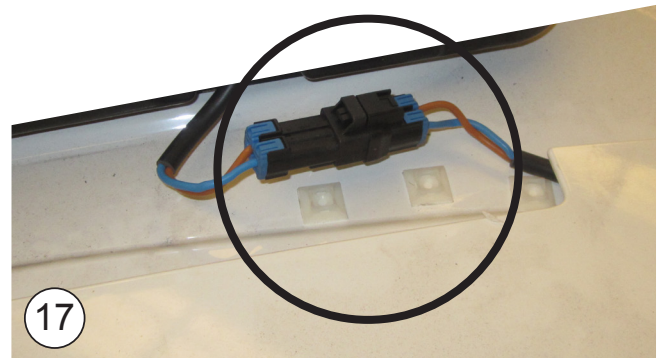

18

Loosen the right side spoiler mounts and pass the wiring underneath, next to the corner of the cabin, and leave the spoiler mounts in original position.



19

Secure the wiring underneath the spoiler with the mounts, with adhesive and plastic flanges.

Caution: clean the area thoroughly before attaching the mounts with adhesive.



20

Secure the wiring with mounts with adhesive and flanges to the cabin, side spoiler mount and original wiring.

Caution: clean the area thoroughly before attaching the mounts with adhesive.

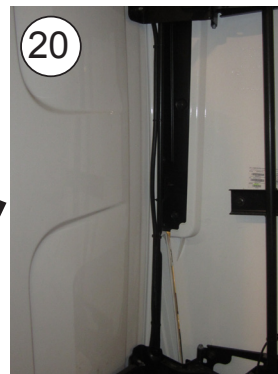

21 Tilt the cabin and run the wiring underneath the protector (*) to the front part of the cabin, securing to the original wires with flanges.

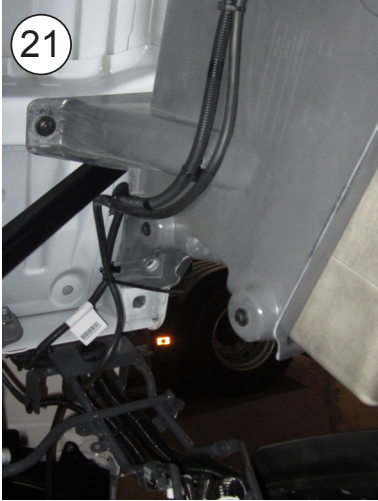
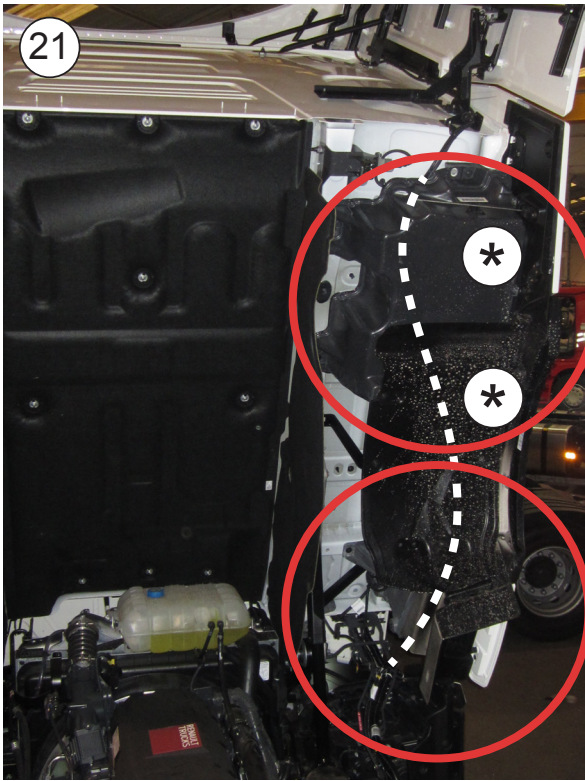

22 Leave the cabin in operating position and take down the original wiring run and connections covers (*).

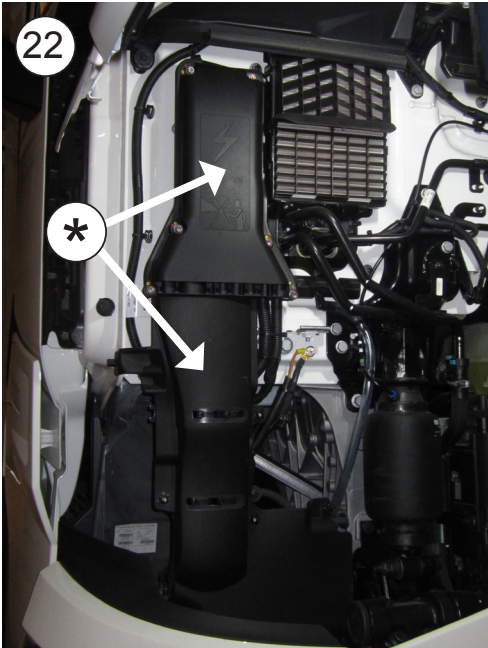

23

Connect the wires to the original (+) and (-) connection points, passing them with the original wiring. Secure the fuse to the original wiring using plastic flanges.

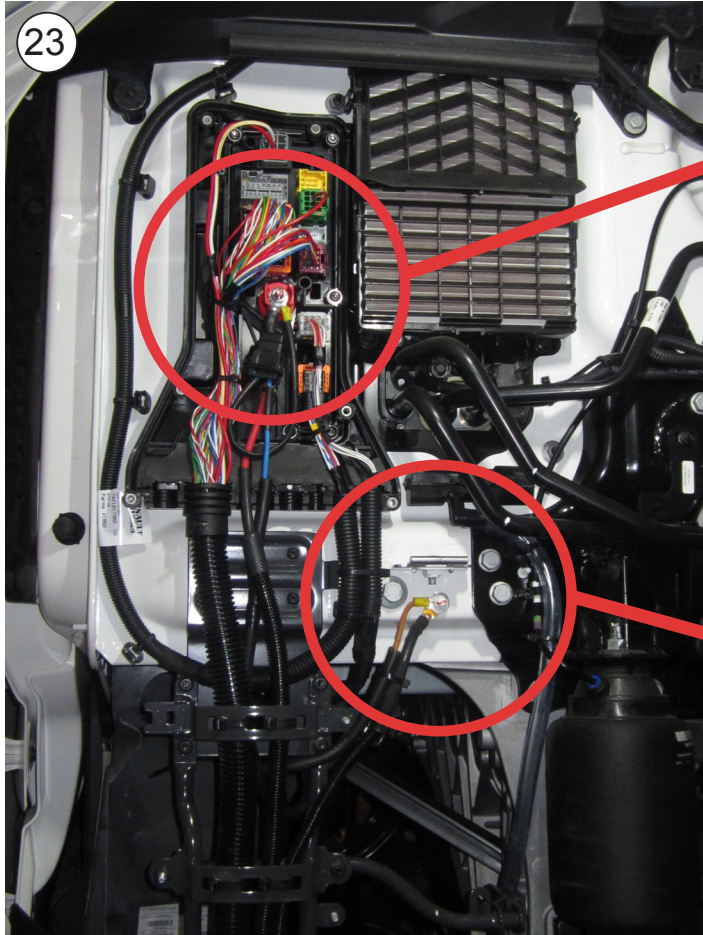
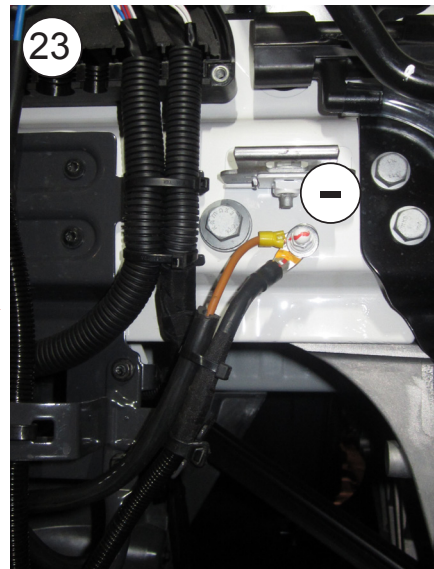
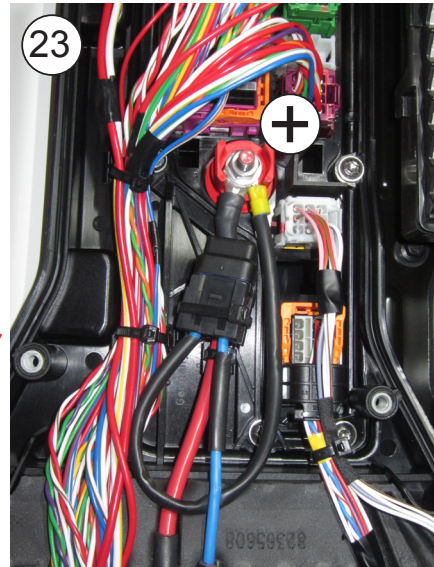

Caution: The unit must not be started up until at least one hour after leaving the cabin in operating position.

IMPORTANT WARNING!

Take care not to invert polarities when connecting the unit to the power supply. If this happens, the plate does not come on and the unit does not work.

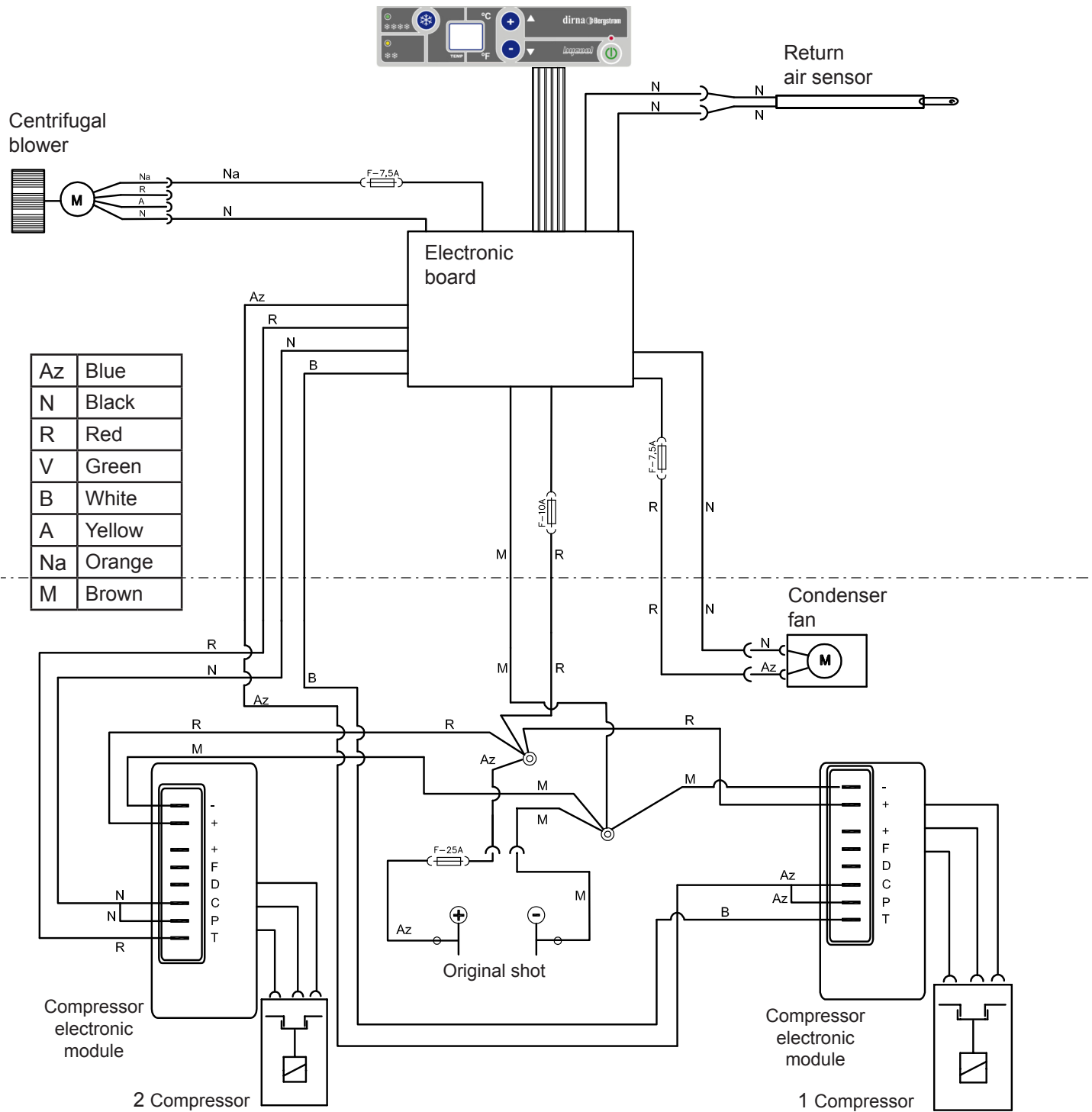

Recommandations Pour Le Montage

- Avant de commencer le montage de l'appareil, prière de lire les instructions et de les suivre attentivement.
- Utiliser les outils convenant à chaque opération.

Electricity

- Déconnecter la clé de contact.
- Déconnecter la batterie avant de commencer le montage.
- Vérifier le câblage des composants électriques et leur correcte installation.



Attention

Si pendant le montage l'équipement est incliné, il faudra attendre au moins 60 minutes avant de le mettre en marche une fois qu'il aura été remis sur sa position horizontale.



Attention

Lors de l'installation de l'appareil d'air conditionné sur le toit, il faudra protéger la partie supérieure de la cabine avec un linge ou une couverture de protection afin d'éviter les éventuelles égratignures.

Durant l'installation du **Compact**, tenir compte du fait que normalement les cabines pourvues d'écoutille possède une structure suffisamment solide pour supporter le poids de l'appareil. Cependant, si ce n'est pas le cas et qu'il est nécessaire de découper le toit ou même si disposant d'écoutille, la structure n'est pas suffisamment rigide (si elle était en fibre, plastique, etc.) il appartiendra à l'installateur de décider s'il faut renforcer le toit pour éviter toute déformation, rupture ou voie d'eau, etc., et prendre les mesures nécessaires à cet effet.

Outils

Jeu de clés Torx

Jeu de clés Allen

Clé fixe 10, 13, 14

Ciseaux

Mètre

Documentation included

Instructions de montage	1000977876
Guide de l'utilisateur	220AA35378
Solution des problèmes	220AA35379
Garantie	220AA10017

Symbologie



Fragile



Attention aux coupures !



Risque électrique



Garantie

⚠ L'installateur devra posséder la formation pertinente en air conditionné sur véhicules.

⚠ **dirna Bergstrom, s.l.**, ne sera pas responsable des dommages ou des bris dérivés d'une installation ou d'une manipulation incorrecte ni des modifications réalisées sans autorisation expresse par écrit.

⚠ **Appareil pré-chargé de gaz réfrigérant R-134. (Ne pas manipuler le circuit de gaz réfrigérant).**

⚠ Voir la **procédure de garantie** du produit au **Diagnostic de problèmes**.

⚠ Voir le **Guide de l'Usager** de l'appareil pour le fonctionnement correcte de la télécommande et du tableau de commande.

⚠ Once installation is finished, the following documents must be handed over to the user: **User's Guide, Warranty and Troubleshooting**.



Les modifications à réaliser sur le spoiler doivent être autorisées par le client. Dirna Bergstrom ne sera en aucun cas responsable des modifications effectuées sur le spoiler.

1

Démonter la console d'origine et tirant sur l'extrémité des lumières pour accéder aux vis de fixation.
Si des leds sont installés (*), il faudra les démonter en les tirant.



2

Démonter ensuite l'écouille en retirant la vis de fixation de cette dernière (dans une écouille électrique, déconnecter la borne (*)).

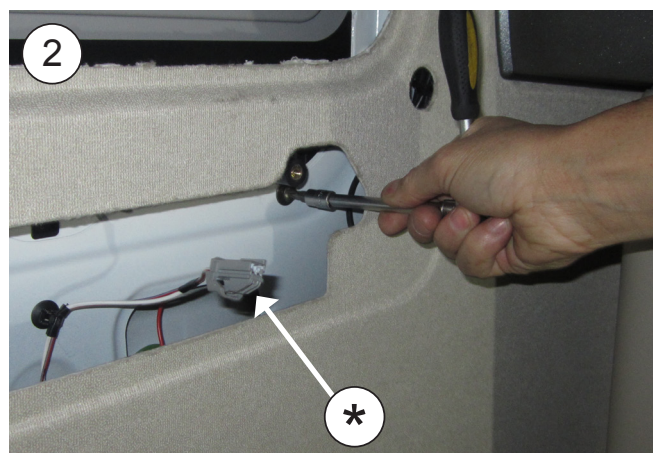

3

Nettoyer le contour de l'écouille et coller le joint EPDM 30x25 à l'extérieur du bossage du contour du creux de l'écouille.



4

COMMENT COUPER LE JOINT EPDM POUR EVITER LES FILTRATIONS DANS LA CABINE

- A- Coller le joint en maintenant une protection en papier de 100 mm de chaque côté.
- B- Retirer les deux morceaux de papier.
- C- Coller en faisant pression sur les deux extrémités.

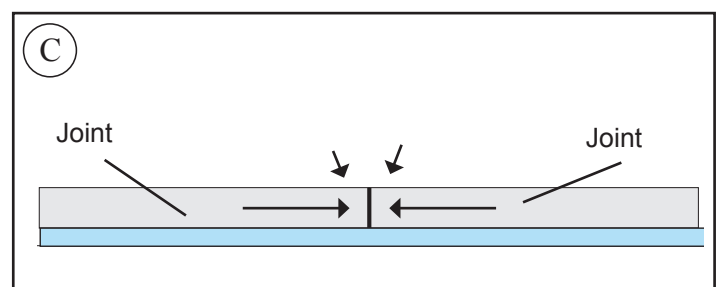
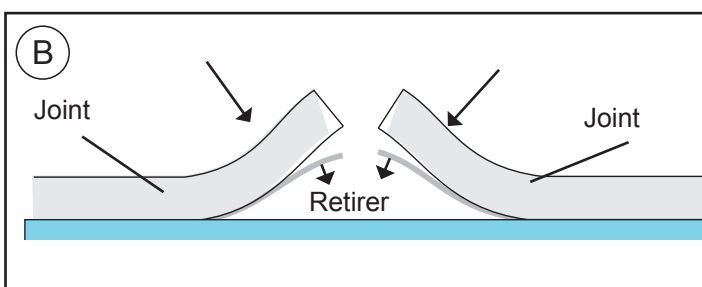
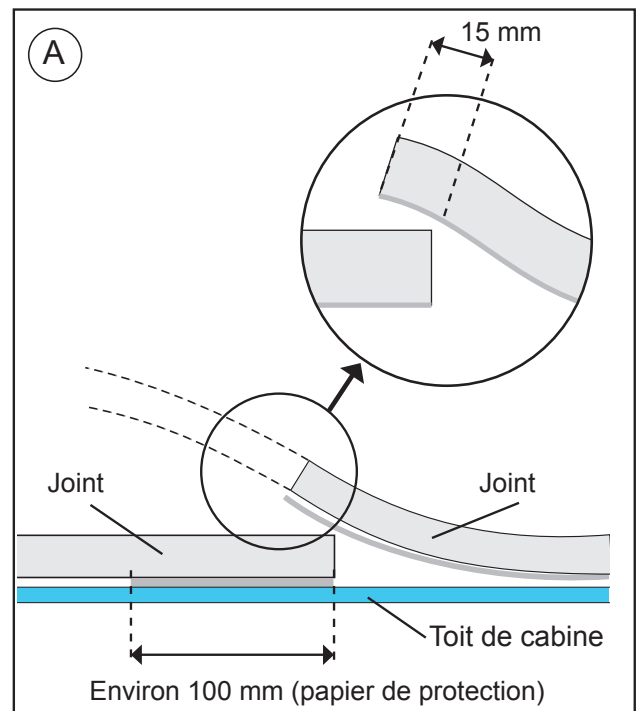

5 Introduire une rondelle plate Ø 8 surface large et une rondelle en caoutchouc Ø 20 x Ø 7 x 3.

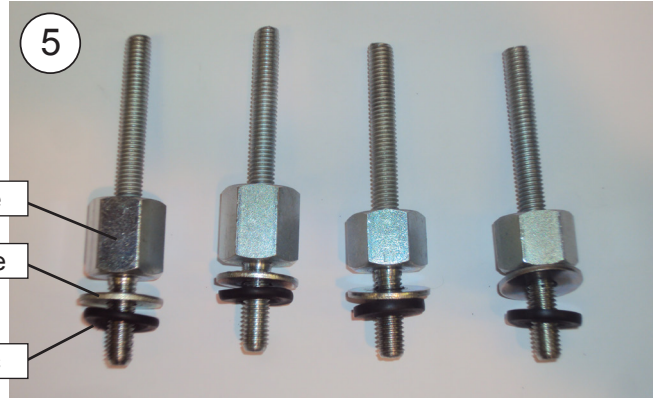

Hexagone
Rondelle plate
Rondelle caoutchouc

6 Placer l'équipement sur la position verticale et visser les hexagones dans les inserts en respectant la position indiquée. Serrer avec un couple de serrage $12,7 \pm 10\%$ Nm.

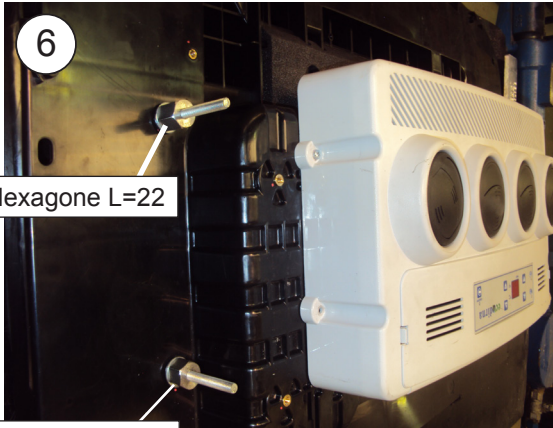

Hexagone L=22
Hexagone L=17

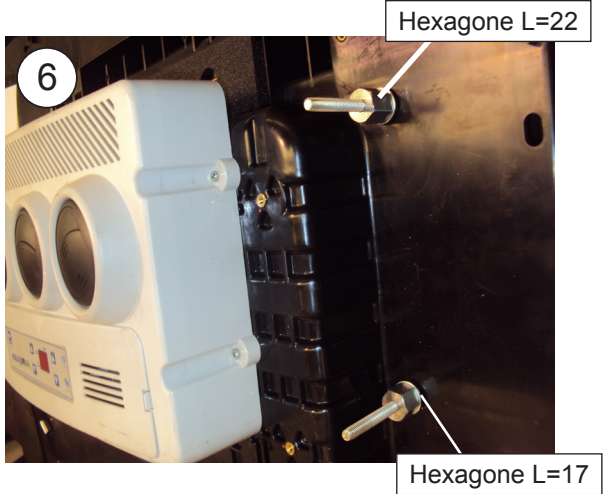

Hexagone L=22
Hexagone L=17

7 Visser (4) centreaux dans les supports centraux en respectant la position indiquée.

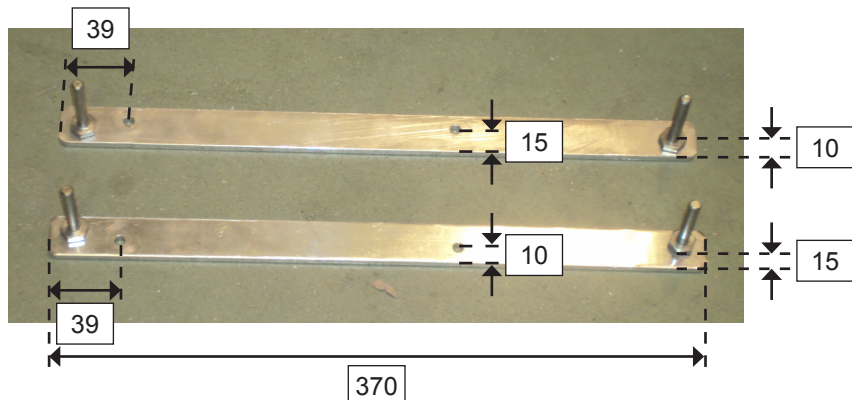

- 8** Monter des centreurs dans la base avec (4) vis (200TX40016) 4x16, en respectant la position indiquée avec un couple de serrage de 4,75x10% Nm.

Partie avant de l'équipement

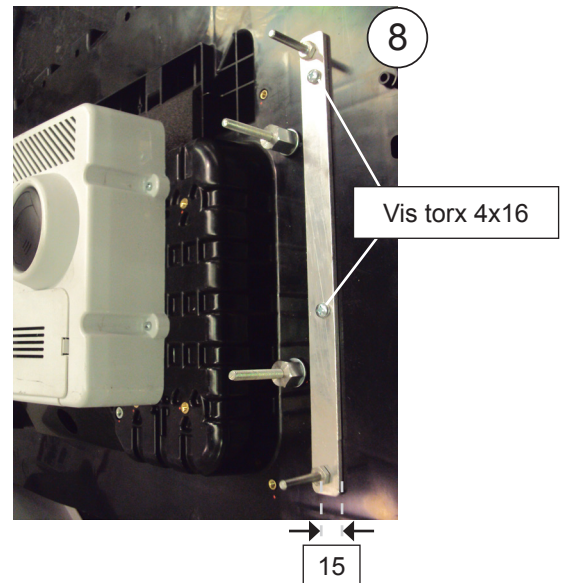
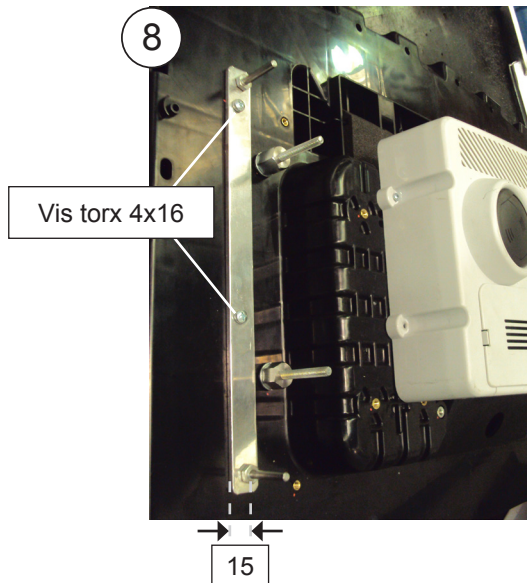

- 9** Placer l'équipement sur le creux de l'écouille en introduisant les guides dans les trous de la cabine (toujours avec l'autorisation du client).
Attention : si l'équipement reste collé au spoiler, marquer et effectuer une coupure sur celui-ci pour le libérer.

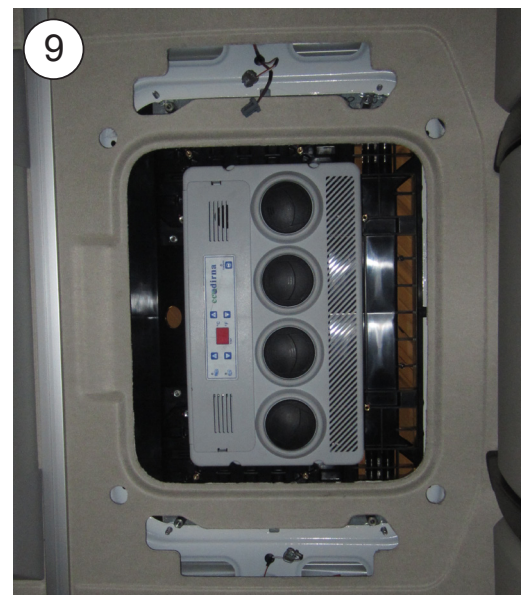
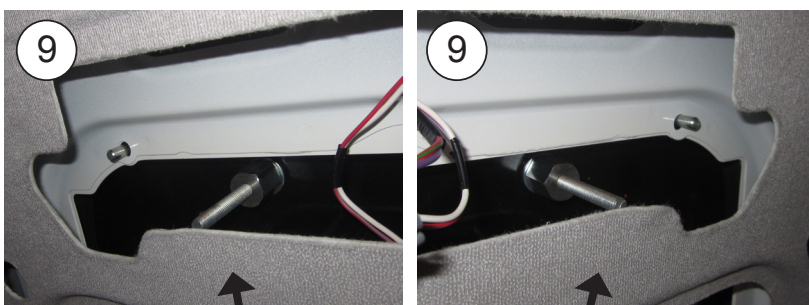

10

Introduire des supports dans les goujons M8 sous la tapisserie.

Attention : il est très important de retirer les agrafes de fixation du câblage de l'écoutille pour que les supports n'écrasent pas les câbles.

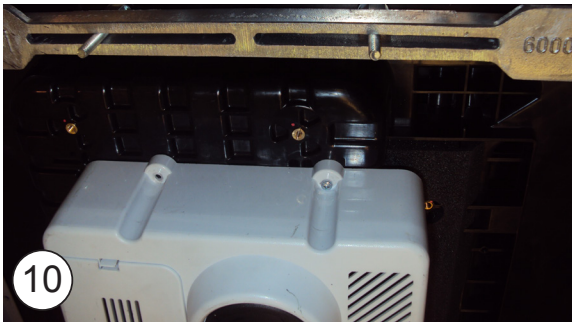
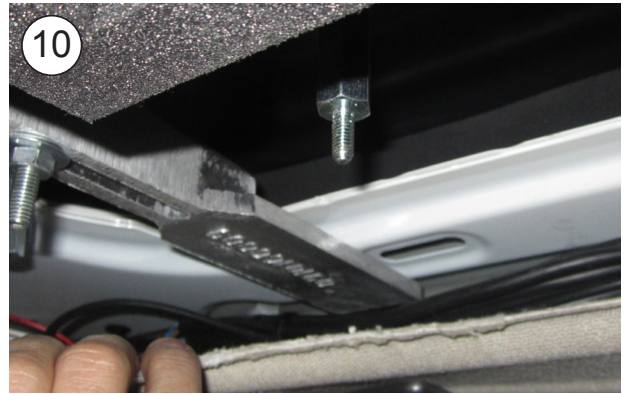

11

Monter les hexagones M6 sur les supports en respectant la position indiquée et en serrant avec un couple de serrage.

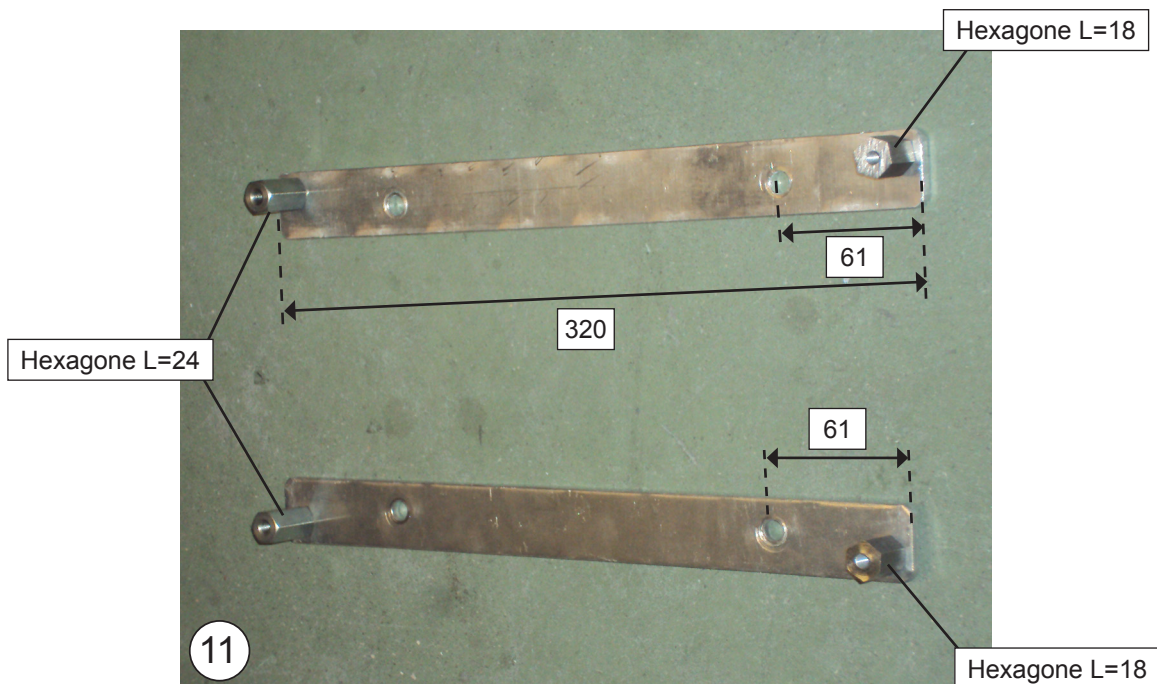

12

Introduire les supports avec des hexagones dans les inserts M8 sur les supports de fixation. Les hexagones doivent rester à l'extérieur des goujons, ceux de L=24 sur la partie arrière de la cabine et ceux de 18 sur la partie avant.

Vue côté gauche cabine

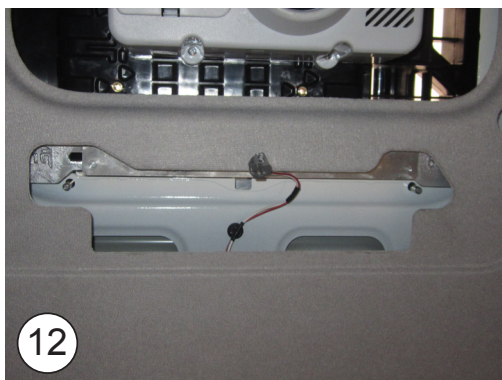
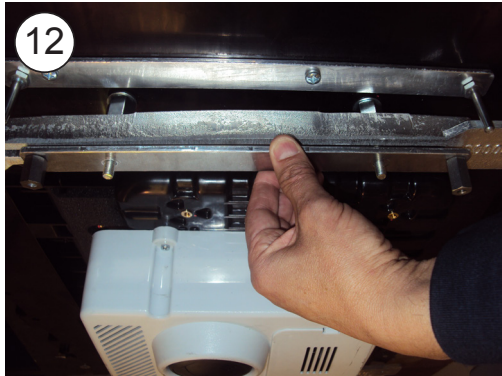

Vue côté droit cabine

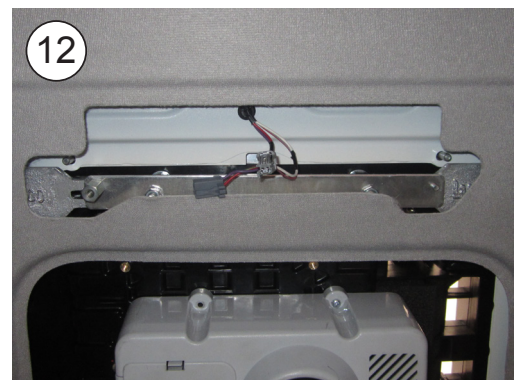
**13**

Introduire une rondelle plate Ø 8 et un écrou M8 autobloquant dans chaque goujon.

Vue côté gauche cabine



Vue côté droit cabine



14

Vérifier que les supports fournissent un appui optimal sur la partie avant et arrière et qu'il n'y ait pas de câbles risquant d'être aplatis. Serrer les écrous M8 jusqu'à ce que les supports atteignent les hexagones de la base.

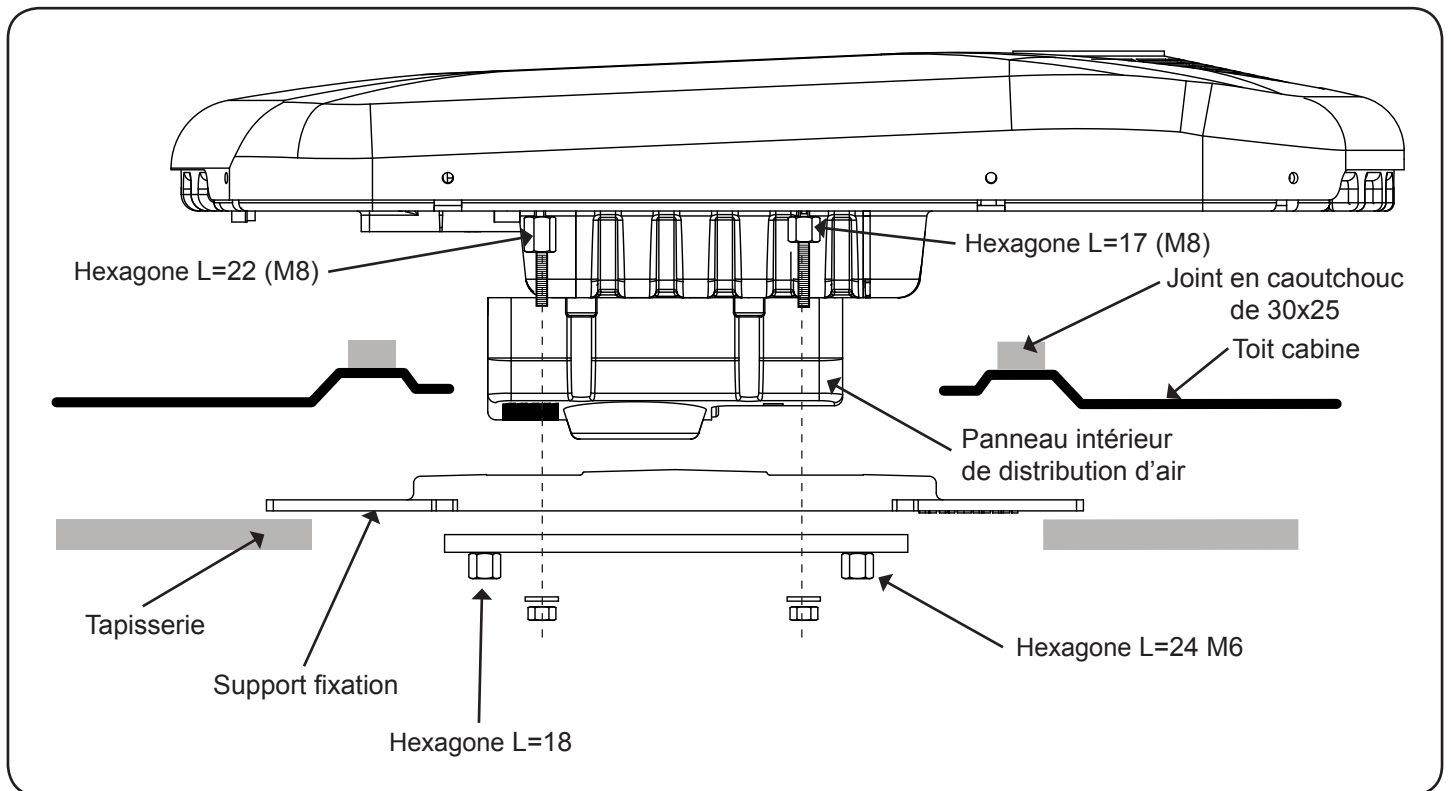
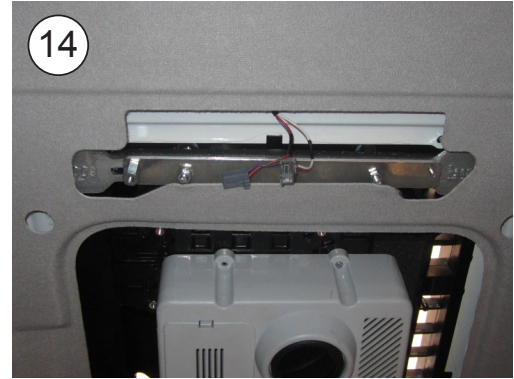
**15**

Placer la console sur le panneau intérieur de distribution d'air et fixer avec (4) vis 6/100x10 tête phillips et avec (4) rondelles plates Ø 6 à larges bords en vissant en hexagones.

16

Connecter les lumières originales et les introduire dans la console en exerçant une pression sur elles.



17

Connecter le câblage d'alimentation à l'équipement, fixer les bornes de connexion au plafond avec des supports avec de l'adhésif et des brides en plastique.

Attention : nettoyer correctement la zone avant de coller les supports avec de l'adhésif.

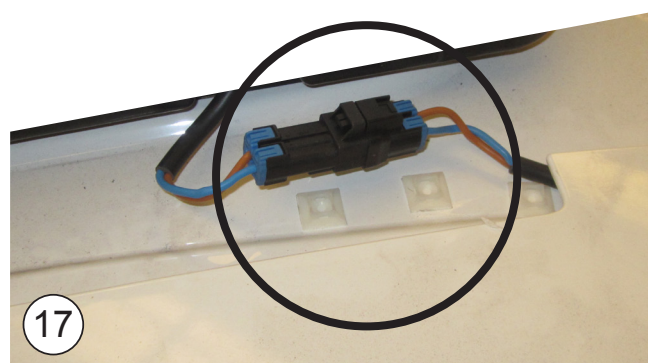
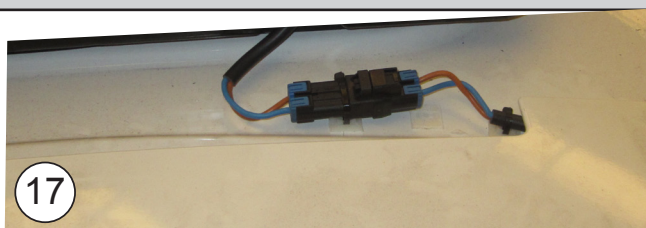

18

Desserrer les supports du spoiler, côté droit, et passer le câblage par dessous, collé à l'angle de la cabine. Laisser les supports spoiler sur leur position d'origine.



19

Fixer le câblage sous le spoiler avec des supports avec de l'adhésif et des brides en plastique.

Attention : nettoyer correctement la zone avant de coller les supports avec de l'adhésif.



20

Fixer le câblage avec des supports avec de l'adhésif et des brides à la cabine, support spoiler latéral et câblage original.

Attention : nettoyer correctement la zone avant de coller les supports avec de l'adhésif.

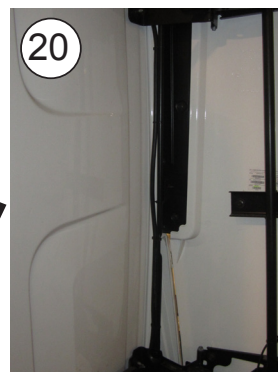

21

Abattre la cabine et passer le câblage sous le protecteur (*) jusqu'à la partie avant de la cabine en la fixant avec des brides au câble original.

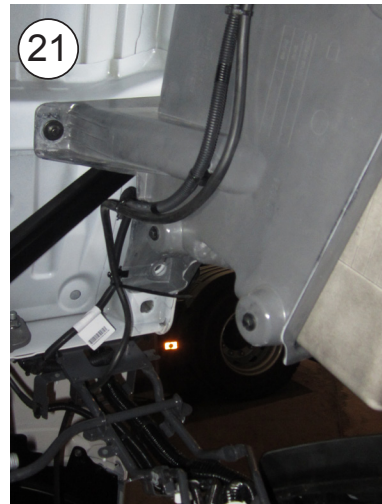
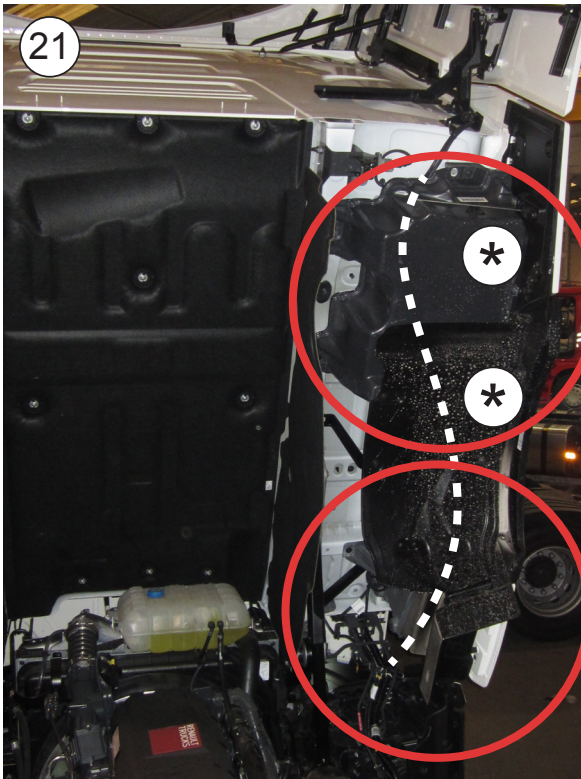

22

Laisser la cabine sur la position de marche et démonter les couvercles des connexions et le passage des câblages d'origine (*).

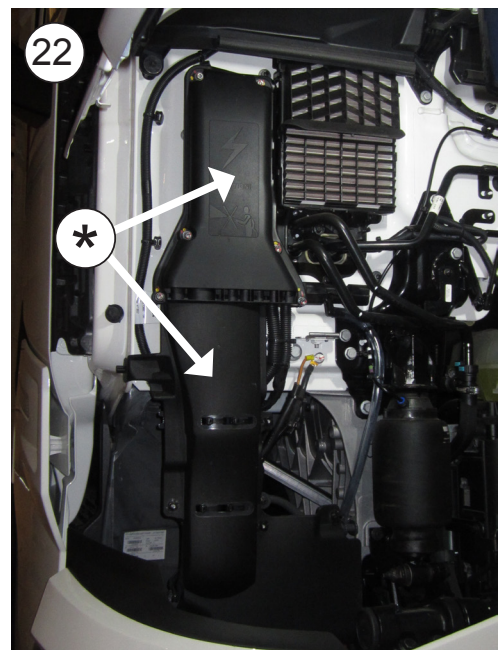

23

Connecter le câblage aux prises originales de (+) et (-) en le passant avec les câblages originaux. Fixer le fusible avec une bride en plastique au câblage d'origine.

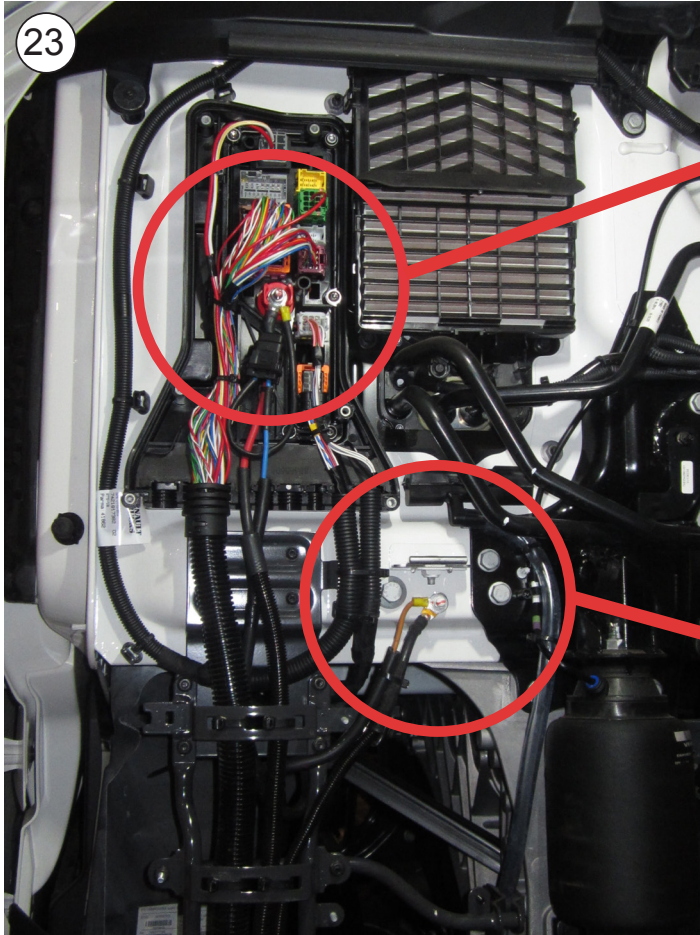
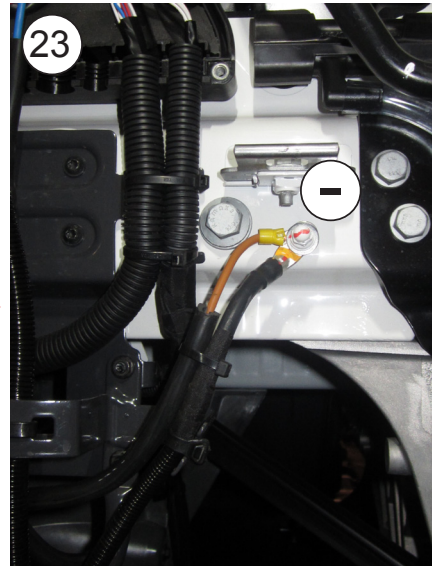
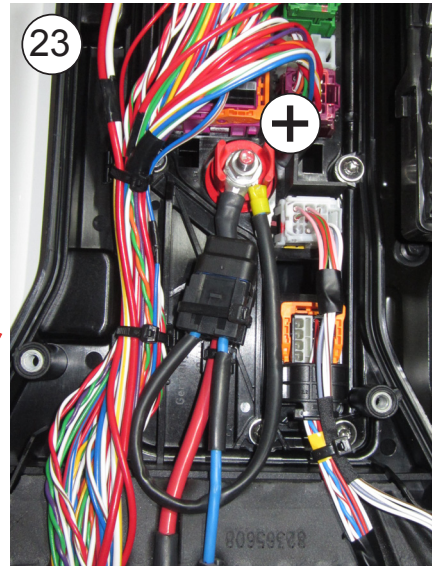

Attention : avant de mettre l'équipement en fonctionnement, il faut attendre au moins une heure après avoir laissé la cabine en position de marche.

Câblage électrique

AVERTISSEMENT IMPORTANT!

Attention de ne pas inverser les polarités au moment de connecter l'alimentation à l'équipement. Si cela se produisait, la plaque ne s'allumerait pas et l'équipement ne fonctionnerait pas.

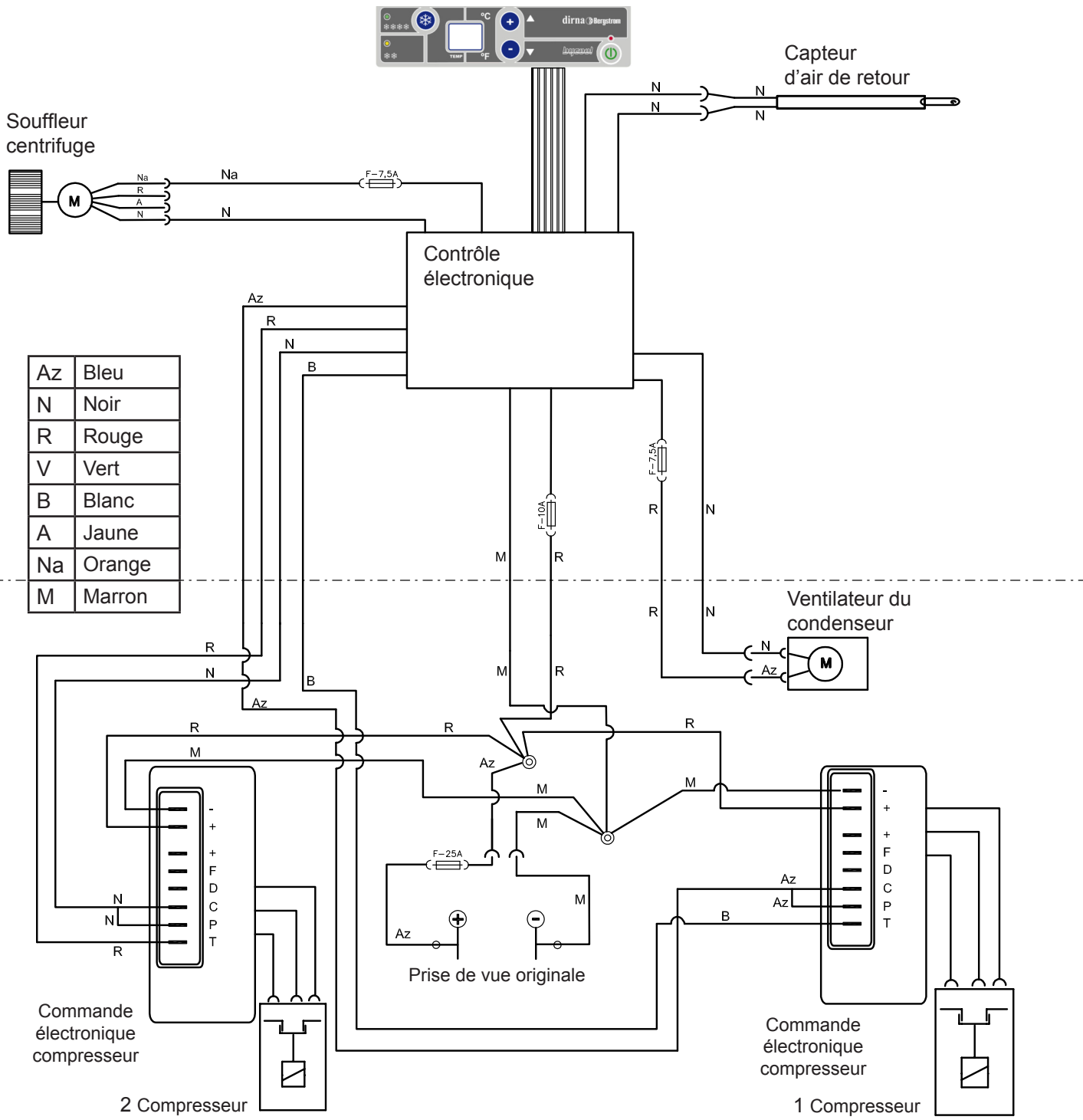

Empfehlungen Zur montage

- Vor und während der Montage bitte diese Anweisungen lesen und beachten.
- Benutzen Sie für jeden Arbeitsschritt die geeigneten Werkzeuge.

Elektrizität

- Zündschlüssel abziehen.
- Vor Montagebeginn die Batterie abklemmen.
- Den ordnungsgemäßen Anschluss und die korrekte Installation der Elektrokomponenten überprüfen.

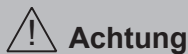

Sollte sich das Gerät während der Montage neigen, muss man mindestens 60 Minuten warten, nachdem es wieder in die horizontale Lage gebracht wurde, um es wieder einzuschalten.

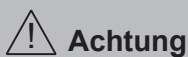

Wird die Klimaanlage im Kabinendach installiert, muss der obere Teil der Kabine mit einem Tuch oder einer Decke gegen eventuelle Kratzer geschützt werden. Bei der Installation der **Compact** auf dem Kabinendach muss darauf geachtet werden, dass mit Luken ausgestattete Kabinen über eine ausreichend stabile Struktur verfügen, um das Gewicht des Geräts stand zu halten. Sollte das Fahrzeug über keine Luke verfügen und sollte es notwendig sein, das Kabinendach aufzuschneiden, bzw. sollte die vorhandene Struktur nicht ausreichend stabil sein (z.B. wenn sie aus Faser, Kunststoff usw. hergestellt ist), obliegt es dem Installateur zu entscheiden, ob das Kabinendach zur Vermeidung von Verformungen, Brüchen, undichten Stellen usw. verstärkt werden muss, und die hierfür notwendigen Mittel bereit zu stellen.

Werkzeuge

- Torx-Schraubenschlüssel
- Inbusschraubenschlüssel
- 10er, 13er, 14er Schraubenschlüssel
- Schere
- Metermaß

Mitgelieferte unterlagen

Montageanweisungen	1000977876
Benutzerleitfaden	220AA35378
Fehlerdiagnose	220AA35379
Garantie	220AA10017

Symbolik



Fragile



Achtung Gericht!



Elektrische Gefährdung

Warnhinweise



Der Installateur muss im Bereich Fahrzeug-Klimaanlagen ausreichend geschult sein.



dirna Bergstrom, s.l. übernimmt keine Verantwortung für Schäden oder Brüche aufgrund einer nicht ordnungsgemäßen Installation oder Bedienung des Geräts oder den Austausch von Teilen bzw. Umbauten, die ohne die erforderliche schriftliche Genehmigung durchgeführt wurden.



Mit Kältemittel vorgefülltes Gerät R-134a. (Kältemittelkreislauf nicht manipulieren).



Siehe **Garantieverfahren** des Produkts in der **Fehlerdiagnose**.



Siehe **Benutzerleitfaden** des Geräts für den ordnungsgemäßen Betrieb der Fernbedienung und des Bedienfelds.



Die folgenden Unterlagen müssen dem Benutzer nach der Installation ausgehändigt werden: **Benutzerleitfaden, Garantie und Fehlerdiagnose.**



Die am Spoiler durchzuführenden Änderungen müssen vom Kunden genehmigt werden. Darum übernimmt dirna Bergstrom keinerlei Haftung für Umbauten am Spoiler.

1

Originalkonsole für den Zugriff auf die Befestigungsschrauben durch Ziehen am Ende der Lampen abnehmen.
Sind Leds (*) vorhanden, für die Demontage an diesen ziehen.



2

Luke durch Lösen der Befestigungsschrauben ausbauen (bei elektrischen Luken deren Klemme (*) abziehen).

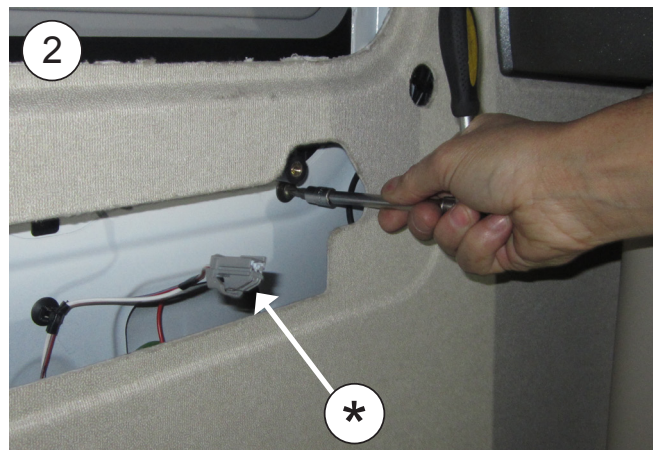

3

Lukenausparung reinigen und EPDM-Dichtung 30x25 von der Außenseite des herausstehenden Teils der Lukenausparung aufkleben.



4

WIE DIE EPDM-DICHTUNG GESCHNITTEN WIRD, UM WASSERUNDICHTIGKEITEN IN DIE KABINE ZU VERMEIDEN

A- Dichtung aufkleben und dabei einen Papierschutz von 100 mm auf jeder Seite beibehalten.

B- Die zwei Papierstücke entfernen.

C- Unter Anpressen beider Enden aufkleben.

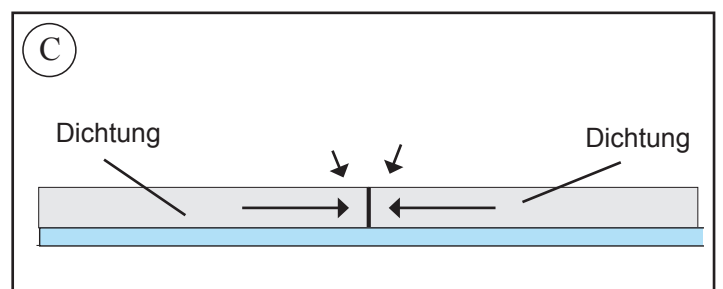
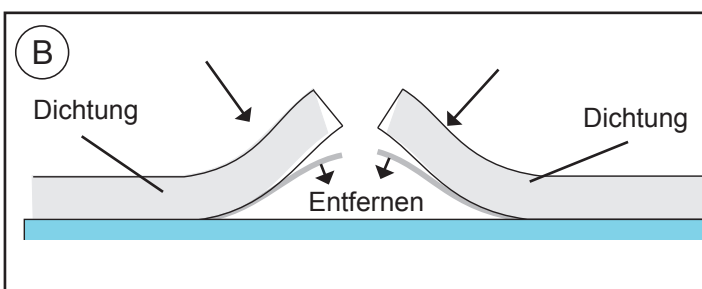
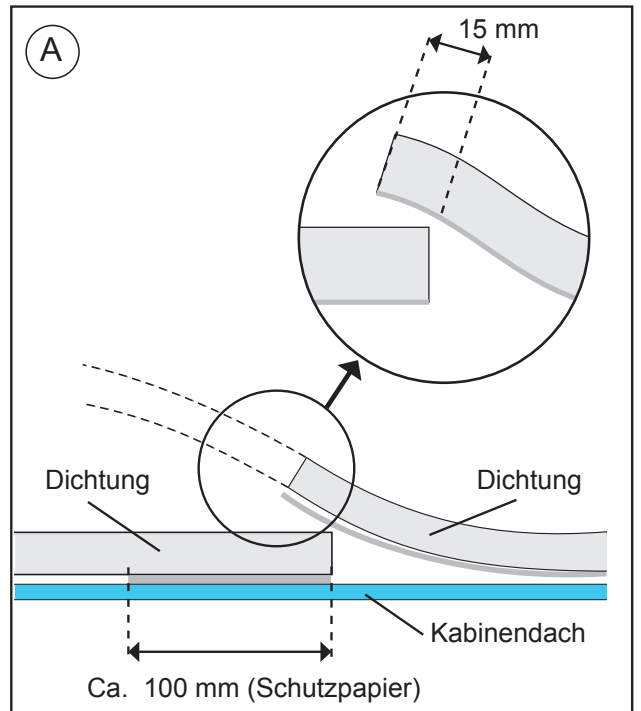

5 Breitflansch-Flachscheibe $\text{\O} 8$ und Gummiauflageplatte $\text{\O} 20 \times \text{\O} 7 \times 3$ anbringen.

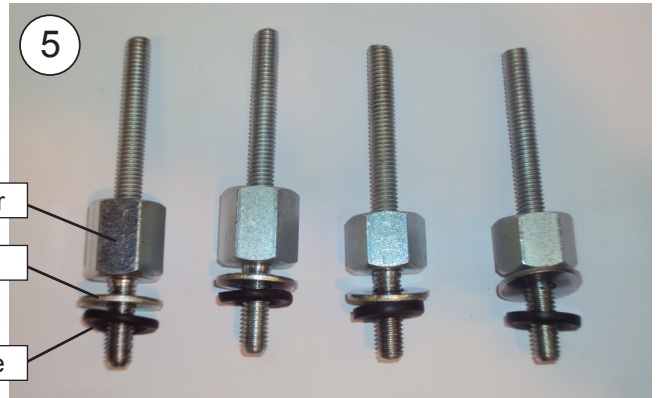

Sechskant-Verbindungs Mutter

Flachscheibe

Gummiauflageplatte

6 Anlage senkrecht stellen und Sechskant-Verbindungs Muttern unter Berücksichtigung der angegebenen Position in die Einsätze schrauben und mit einem Anzugsmoment von $12,7 \pm 10\%$ Nm anziehen.

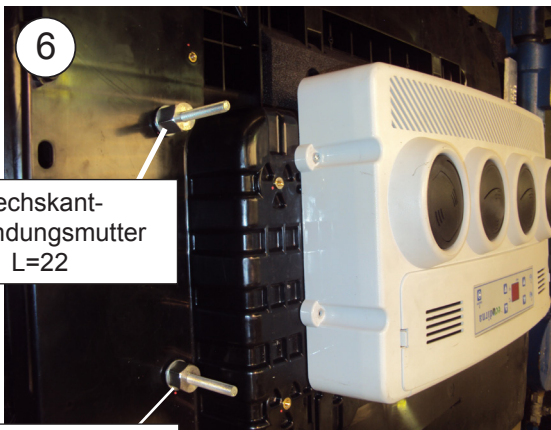

Sechskant-Verbindungs Mutter L=22

Sechskant-Verbindungs Mutter L=17

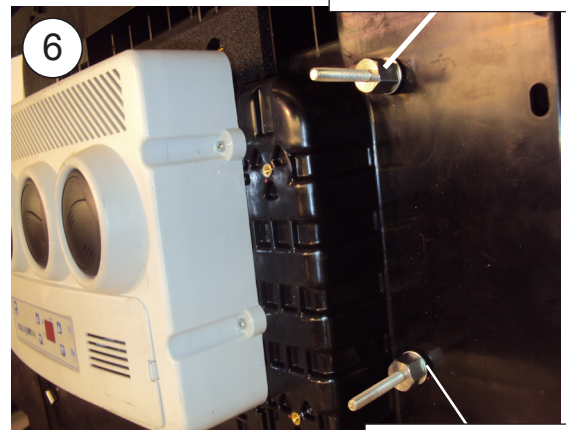

Sechskant-Verbindungs Mutter L=22

Sechskant-Verbindungs Mutter L=17

7 (4) Zentrierer unter Berücksichtigung der angegebenen Position in die Zentrierhalterungen schrauben.

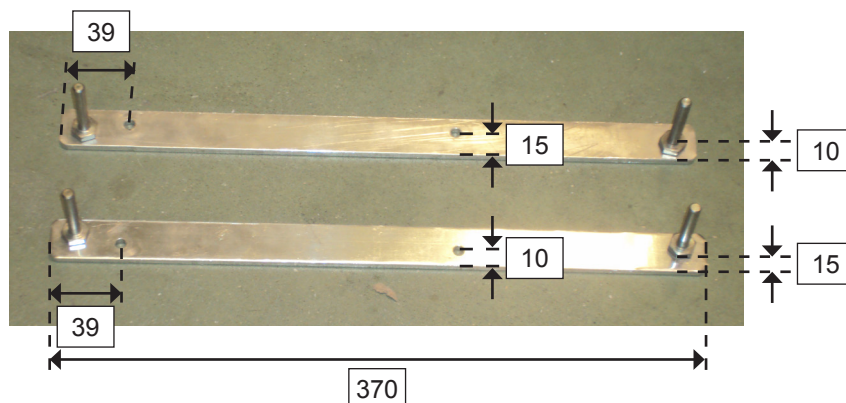

8 Zentrierstifte unter Berücksichtigung der angegebenen Position anhand von (4) Schrauben (200TX40016) 4x16 mit einem Anzugsmoment von $4,75 \pm 10\%$ Nm in die Grundplatte schrauben.

Vorderseite der Anlage

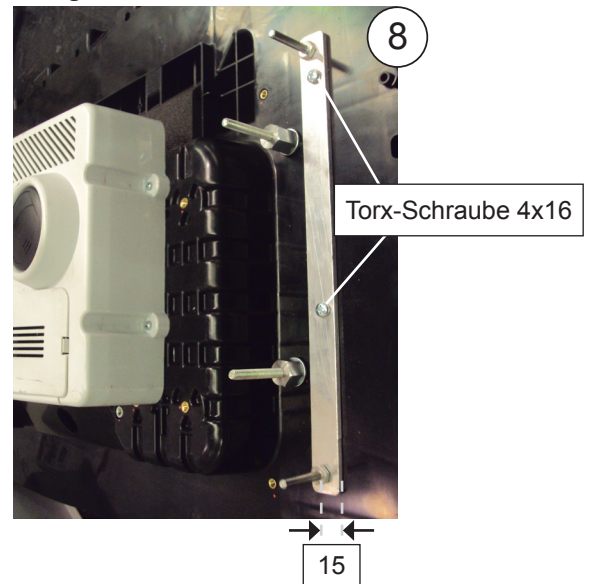
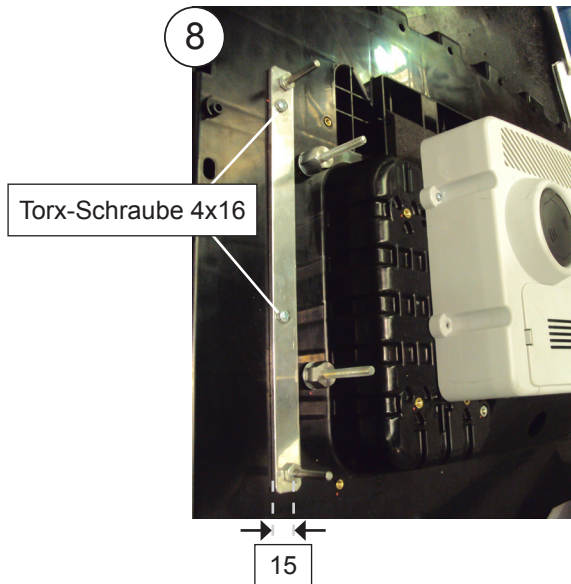

9 Anlage auf die Lukenausparung legen und die Führungen in die Bohrlöcher (immer mit Genehmigung des Kunden) der Kabine stecken.

Achtung: Wenn das Gerät zu dicht am Spoiler ist, diesen entsprechend markieren und aufschneiden.

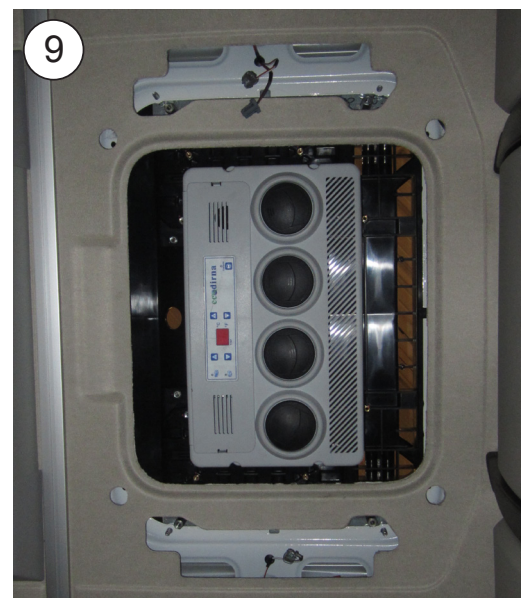
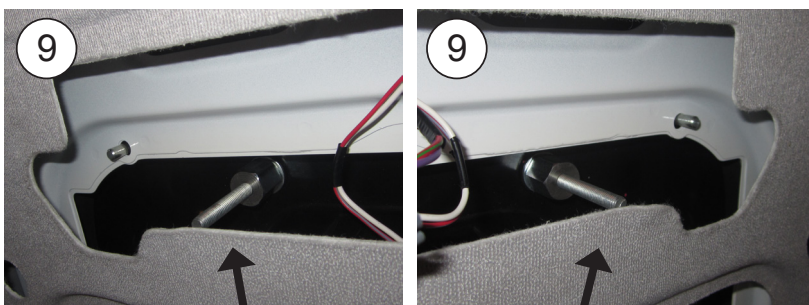

10

Halterungen unter der Verkleidung auf Stiftschrauben M8 stecken.

Achtung: Es ist sehr wichtig, die Befestigungsklammern der Lukenkabel zu entfernen, damit die Halterungen die Kabel nicht abklemmen.

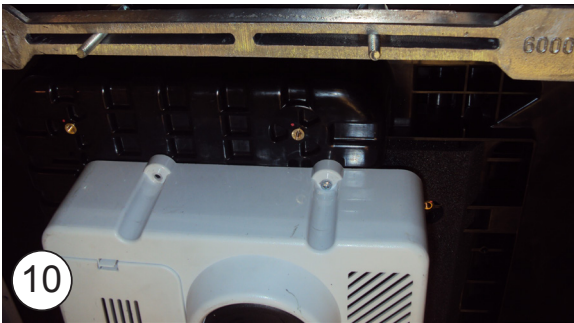
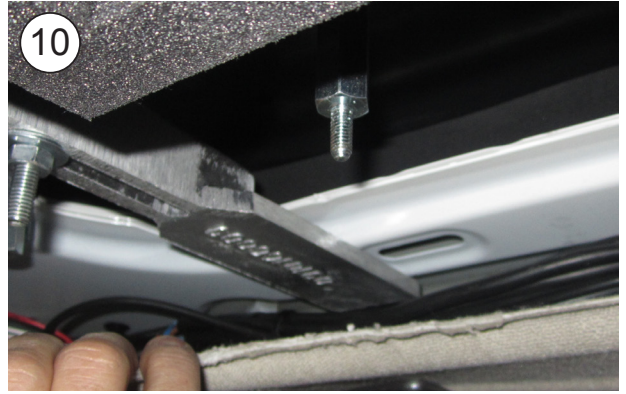

11

Sechskant-Verbindungs-muttern M6 unter Berücksichtigung der angegebenen Position auf die Halterungen schrauben und mit Anzugsmoment anziehen.

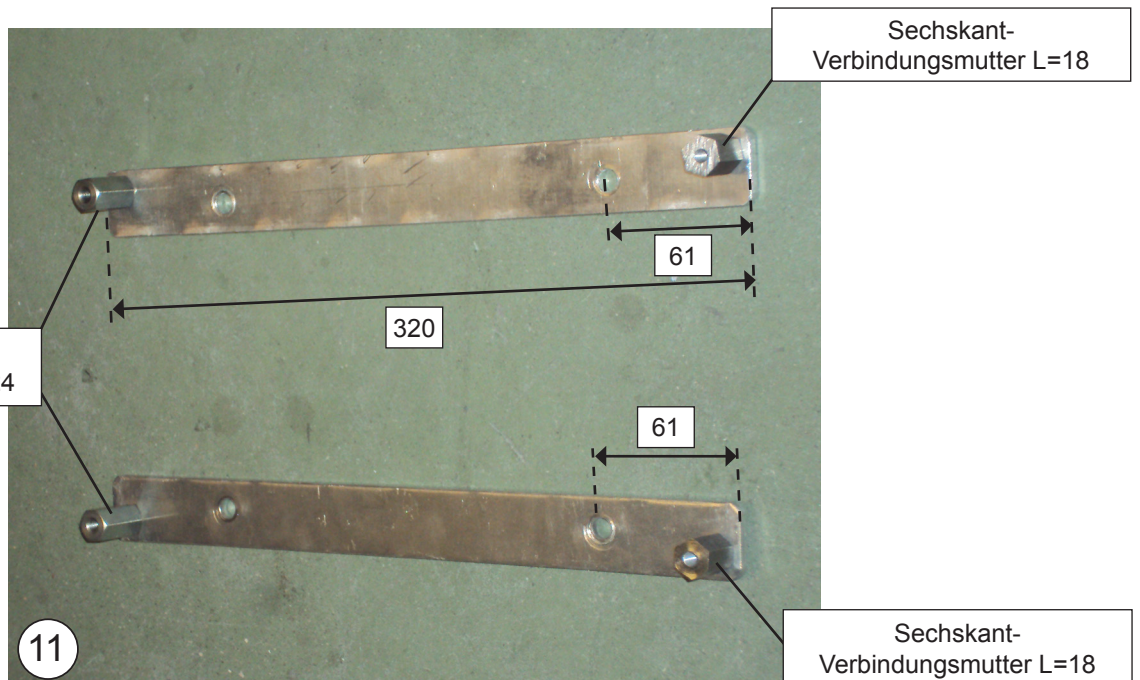

12 Halterungen mit Sechskant-Verbindungs-muttern in Einsätze M8 auf den Befestigungshalterungen schrauben. Die Sechskant-Verbindungs-muttern müssen außerhalb der Stiftschrauben bleiben, wobei sich die L=24 an der Rückseite der Kabine und die L=18 an der Vorderseite der Kabine befinden.

Ansicht Seite links Kabine

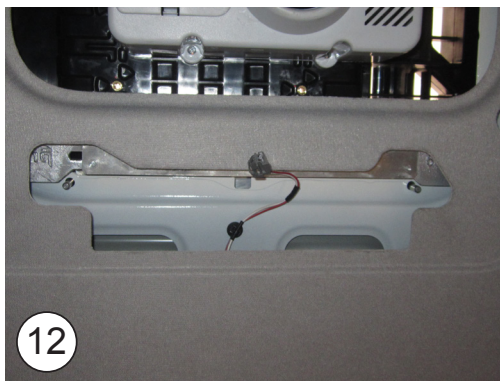

Ansicht Seite rechts Kabine

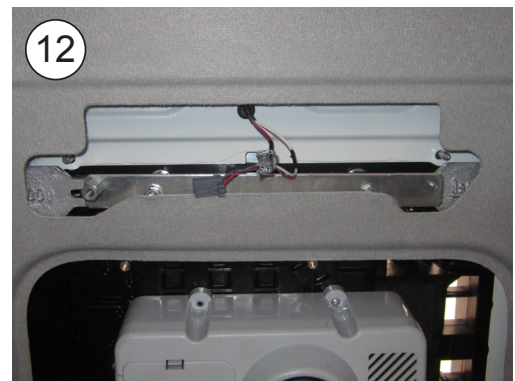
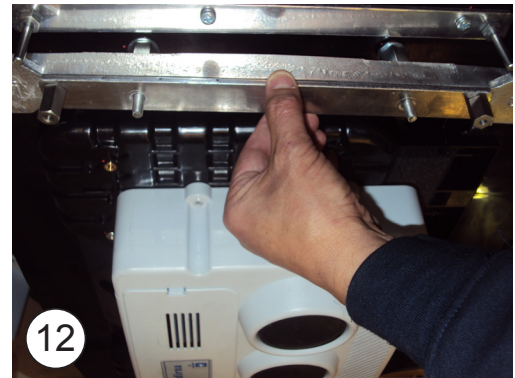

13 Eine Flachscheibe Ø8 und eine selbstsichernde Mutter M8 auf jede Stiftschraube stecken.

Ansicht Seite links Kabine



Ansicht Seite rechts Kabine



14

Prüfen, ob die Halterungen vorne und hinten gut aufliegen und dass keine Kabel abgeklemmt werden können. Muttern M8 anziehen, bis die Halterungen an die Sechskant-Verbindungsmuttern der Grundplatte anschlagen.

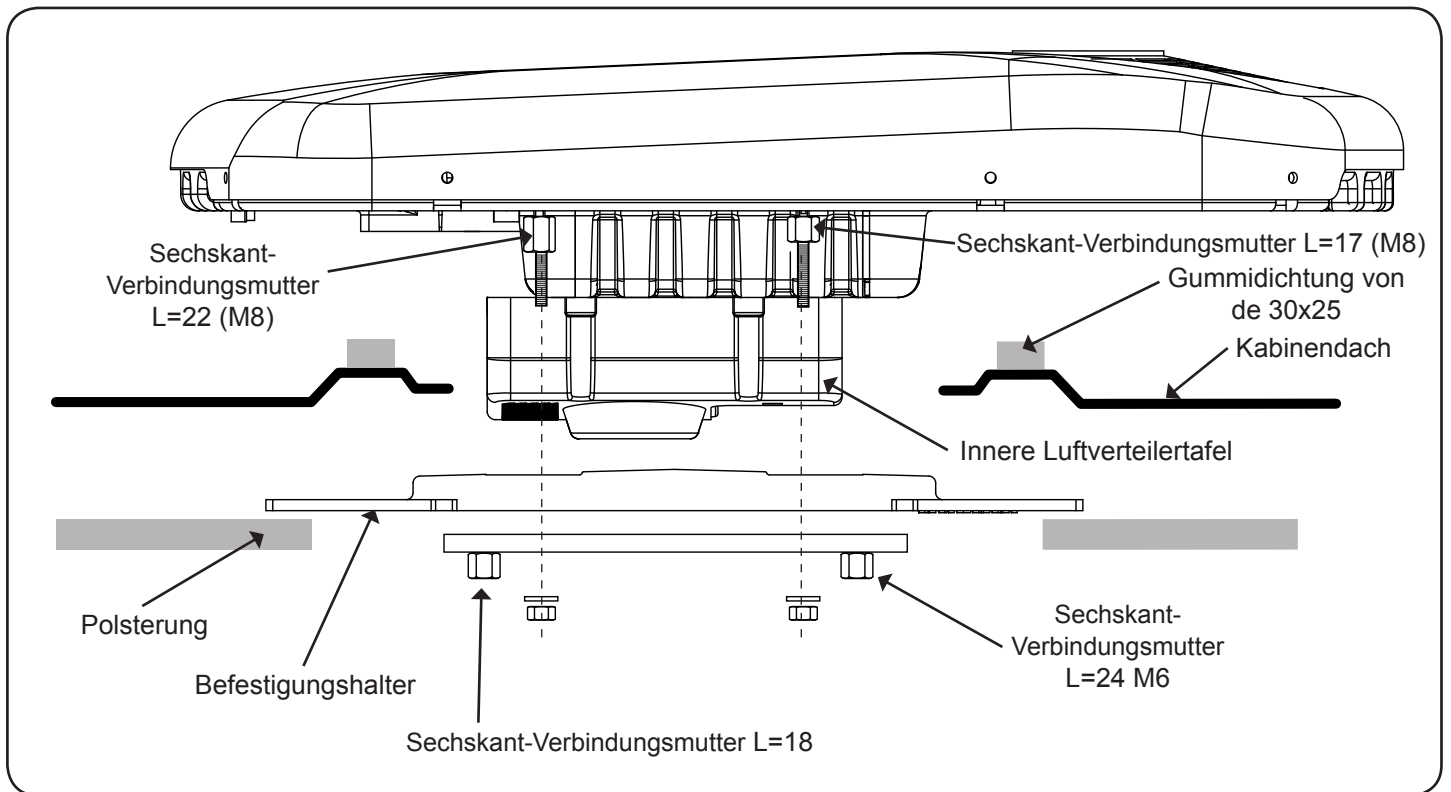
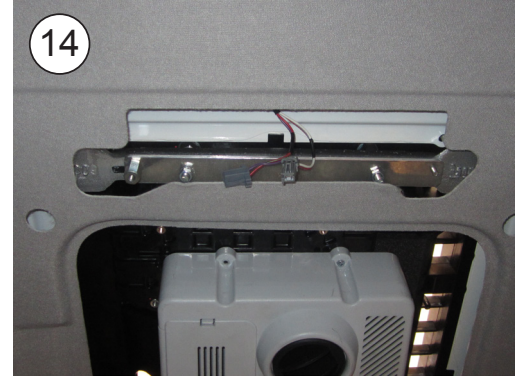

15

Die Konsole auf die untere Luftverteiltertafel legen und mit (4) Kreuzschrauben 6/100x10 und (4) Breitflansch-Flachscheiben $\varnothing 6$ befestigen und in Sechskant-Verbindungsmuttern einschrauben.

16 Originallampen anschließen und an der Konsole durch Drücken befestigen.



17 Netzkabel an der Anlage anschließen. Anschlussklemmen am Dach mit Kabelhaltern und Kleber sowie Kunststoff-Kabelbindern befestigen.

Achtung: Den Bereich vor dem Aufkleben der Halter sorgfältig reinigen.

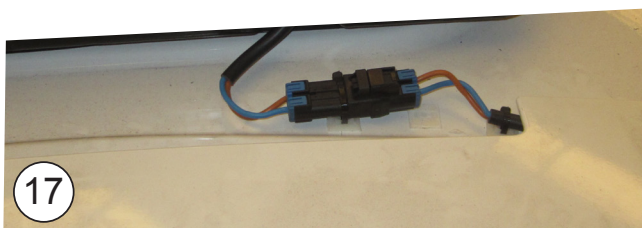
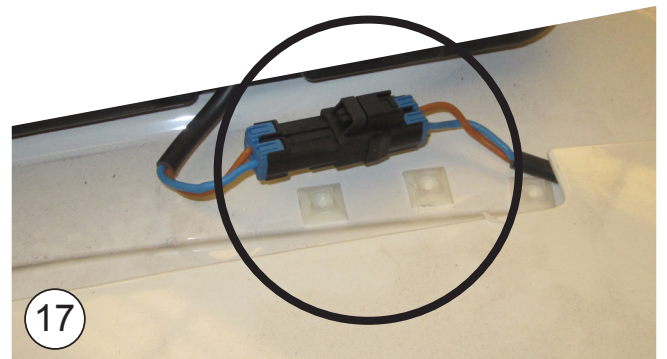

18 Spoilerhalterungen rechts lockern und Kabel direkt an der Kabinenecke darunter hindurchführen. Spoilerhalterungen wieder in die Originalposition bringen.



19

Kabel unter dem Spoiler mit Klebehaltern und Kabelbindern befestigen.

Achtung: Den Bereich vor dem Aufkleben der Halter sorgfältig reinigen.



20

Kabel mit Klebehaltern und Kabelbindern an Kabine, seitlichem Spoilerhalter und Originalkabel befestigen.

Achtung: Den Bereich vor dem Aufkleben der Halter sorgfältig reinigen.

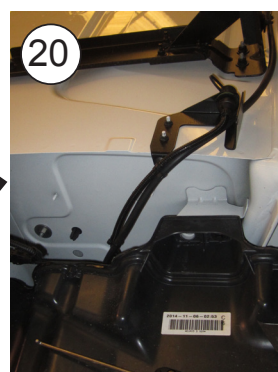

21 Kabine abklappen und Kabel unter der Schutzvorrichtung (*) bis zum vorderen Teil der Kabine hindurchführen. Mit Kabelbindern an den Originalkabeln befestigen.

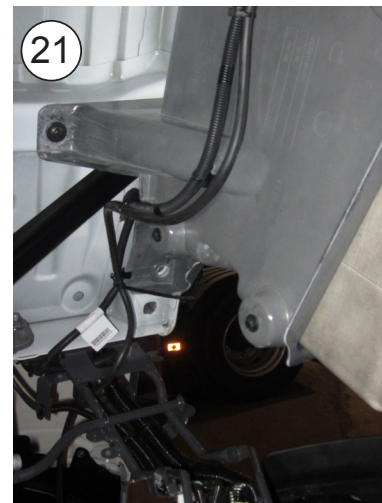
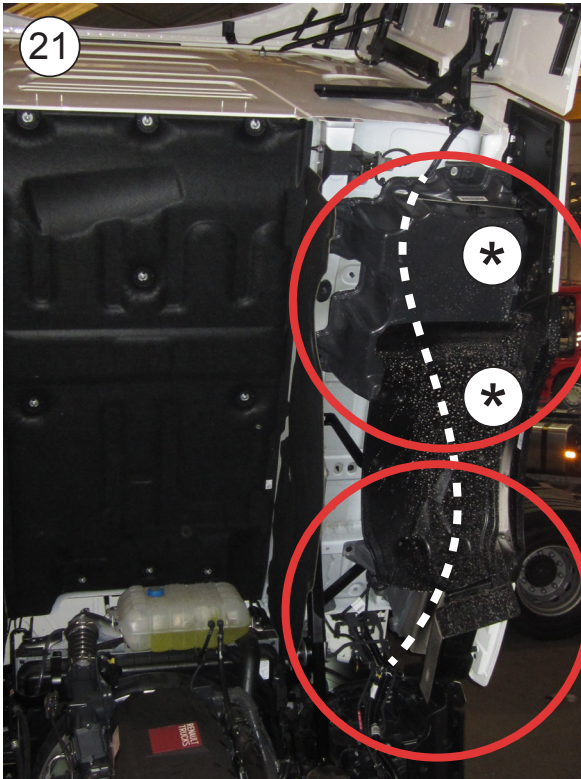

22 Kabine in Fahrposition bringen und Abdeckungen der Anschlusskästen sowie Original-Kabelführungen abnehmen (*).

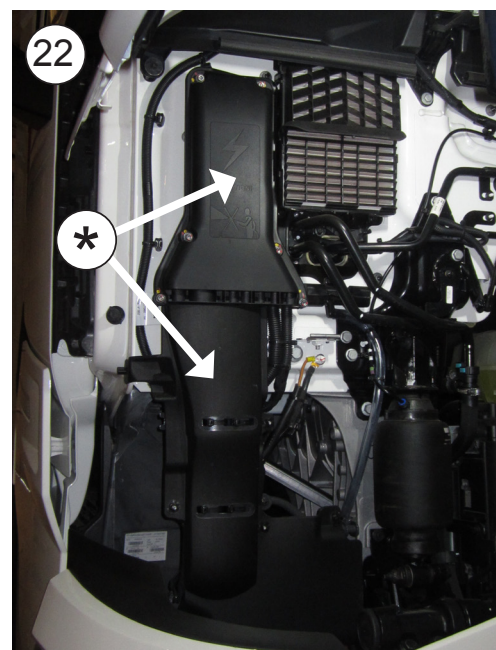

23

Kabel an Originalanschlüsse (+) und (-) anschließen und zusammen mit den Originalkabeln durchführen. Sicherung mit Kunststoff-Kabelbinder an der Originalverkabelung befestigen.

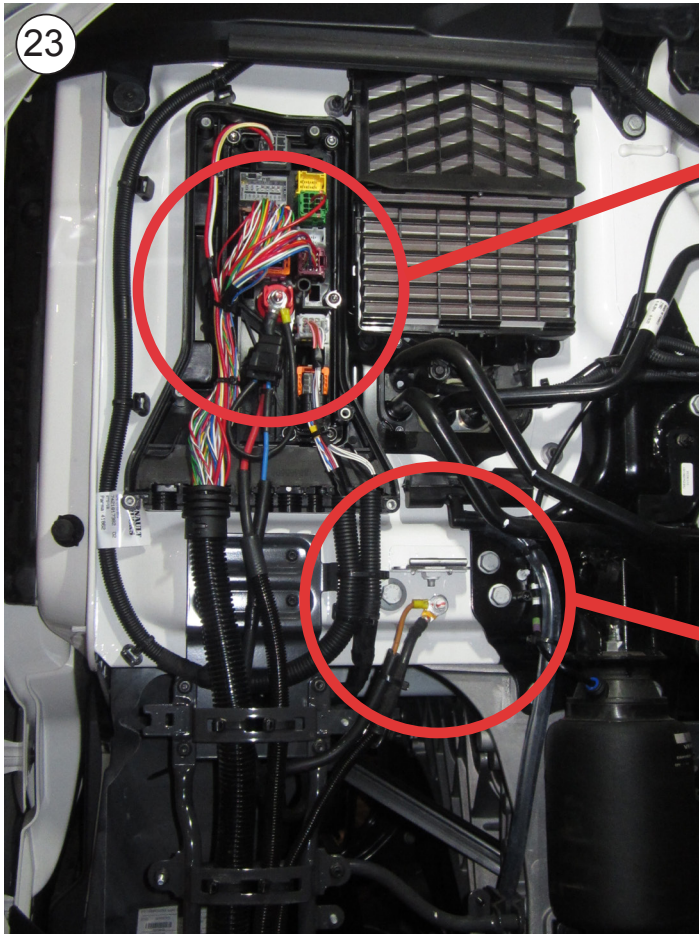
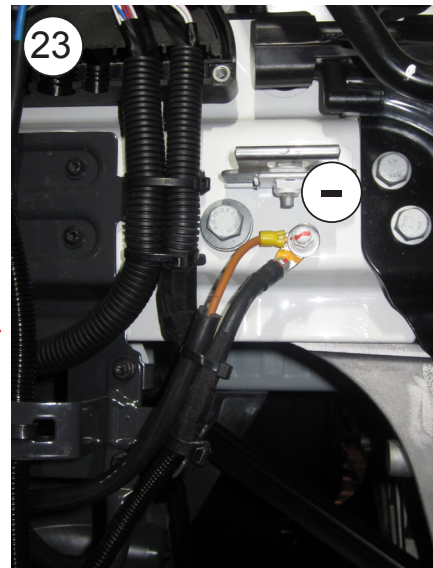
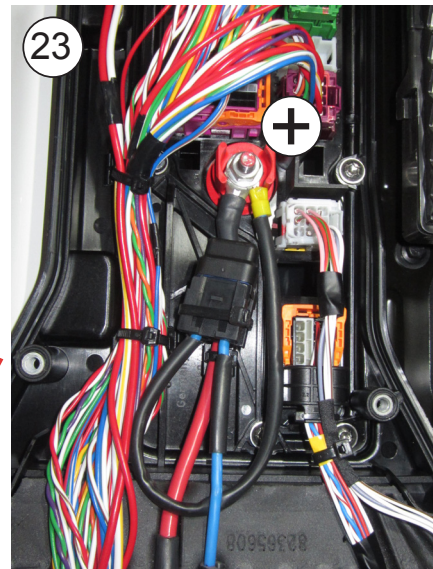

Achtung! Vor der Inbetriebnahme des Geräts mindestens eine Stunde warten, nachdem die Kabine in Fahrposition gebracht worden ist.

Elektrische Verkabelung

WICHTIGER WARNHINWEIS!

Darauf achten, dass die Polaritäten beim Anschluss der Stromversorgung an das Gerät nicht vertauscht werden. Ist dies der Fall, schaltet sich die Elektroniktafel nicht ein und das Gerät funktioniert nicht.

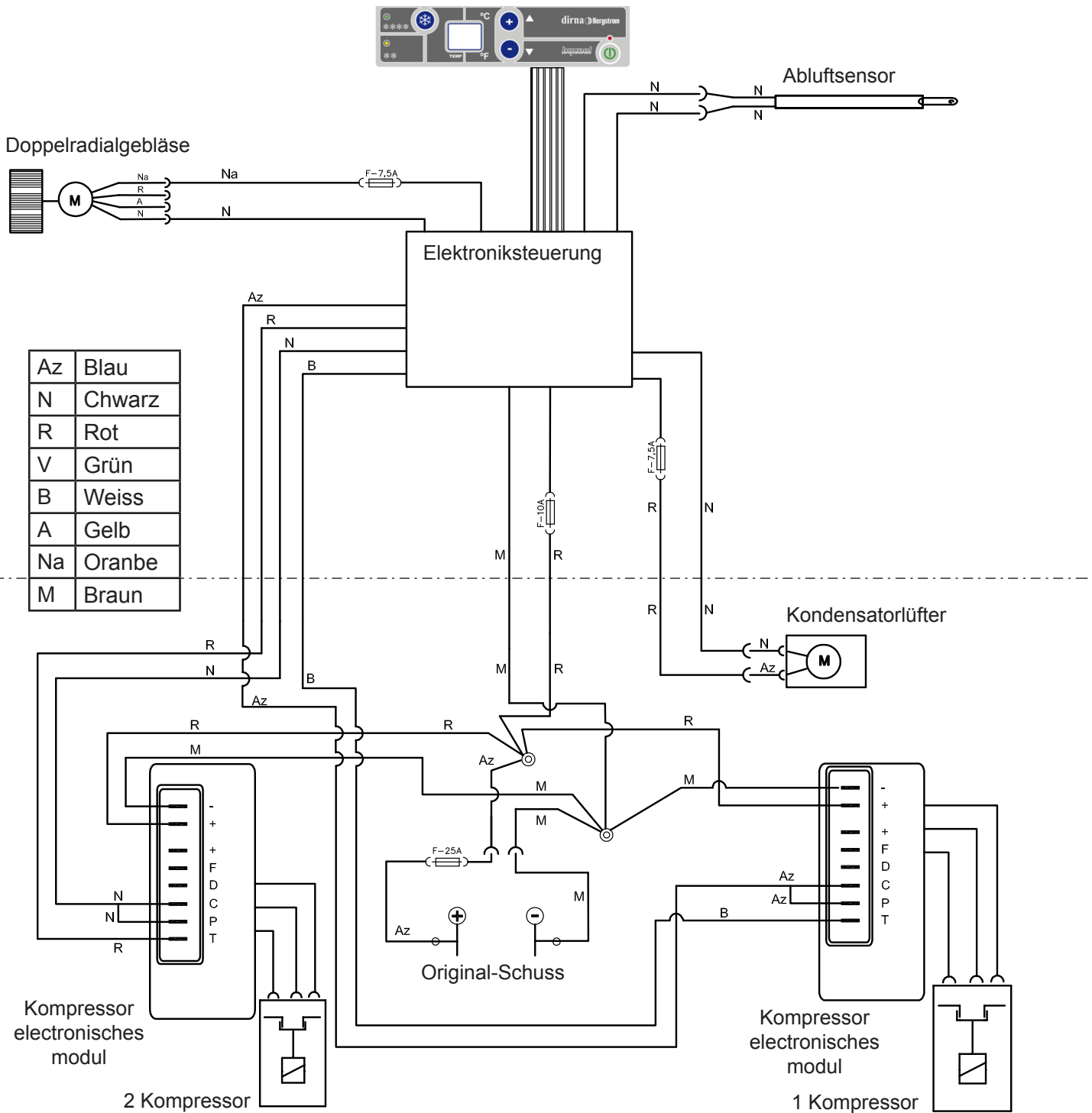

Suggerimenti per il montaggio

- Prima di cominciare il montaggio, leggere attentamente le istruzioni e rispettarle nel corso dello stesso.
- Usare gli attrezzi più adatti ad ogni operazione.

Elettricità

- Scollegare la chiave di contatto.
- Scollegare la batteria prima di cominciare il montaggio.
- Assicurarsi di avere effettuato correttamente l'installazione e il collegamento dei componenti elettrici.

Attenzione

Se durante il montaggio si inclina l'impianto, prima di rimetterlo in funzione occorre attendere almeno 60 minuti dal momento in cui è di nuovo in posizione orizzontale.

Attenzione

Quando si installa l'impianto di aria condizionata sul tettuccio, bisogna proteggere la parte superiore della cabina con uno straccio o una coperta per evitare eventuali graffi. Per l'installazione del **Compact**, tenere presente che normalmente le cabine munite di oblò dispongono di una struttura abbastanza solida per sostenere il peso dell'impianto. Tuttavia, se così non fosse e se fosse necessario tagliare il tettuccio, o se in presenza di oblò la struttura non fosse abbastanza rigida (se fosse di fibra, plastica, ecc.), è responsabilità dell'installatore decidere se occorre rinforzare il tettuccio per evitare qualsiasi deformazione, rottura o penetrazione d'acqua, ecc., prendendo le misure necessarie per evitarlo.

Attrezzi

Kit di chiavi Torx
 Kit di chiavi Allen
 Chiave fissa 10, 13, 14
 Forbici
 Metro a nastro

Documentazione allegata

Istruzioni di montaggio	1000977876
Guida dell'utente	220AA35378
Soluzione dei problemi	220AA35379
Garanzia	220AA10017

Simbologia



Fragile



Attenzione alle mani



Tensione elettrica pericolosa

Avvertenze



L'installatore deve essere in possesso della formazione necessaria in materia di aria condizionata per veicoli.



dirna Bergstrom, s.l. declina ogni responsabilità per danni o rotture derivanti dall'errata installazione o dall'errato uso dell'impianto o da sostituzioni o modifiche effettuate senza la necessaria autorizzazione per iscritto.



Impianto precaricato con gas refrigerante R-134. (Non manomettere il circuito di gas refrigerante).



Vedi la **procedura di garanzia** del prodotto in **Diagnosi dei problemi**.



Vedi la **Guida dell'utente** dell'impianto per il corretto funzionamento del telecomando e del pannello di controllo.



I seguenti documenti devono essere consegnati all'utente una volta conclusa l'installazione: **Guida dell'utente, Garanzia e Diagnosi dei problemi**.



Le modifiche da eseguire sullo spoiler devono essere autorizzate dal cliente. Perciò dirna Bergstrom declina ogni responsabilità per la modifica dello spoiler.

1

Smontare la console originale, tirando l'estremità delle luci per accedere alle viti di fissaggio.

In presenza di led (*) smontare tirando questi ultimi.

**2**

Smontare il tettuccio apribile svitando le viti di fissaggio (in caso di tettuccio elettrico, disinserire il relativo morsetto [*]).

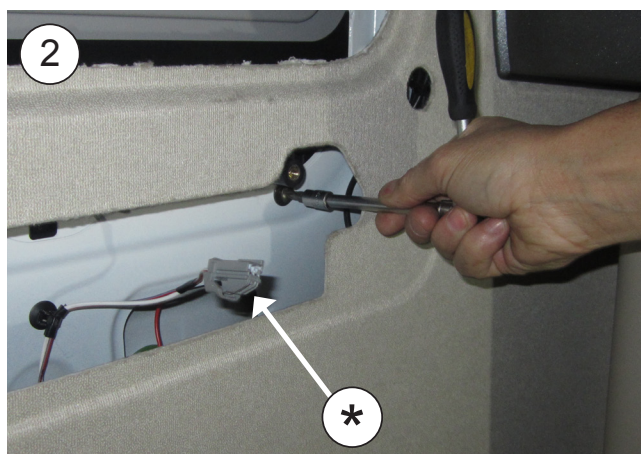

3

Pulire il contorno del vano e incollare la guarnizione EPDM 30x25, dall'esterno della sporgenza perimetrale.



4

COME TAGLIARE LA GUARNIZIONE EPDM PER EVITARE INFILTRAZIONI NELLA CABINA

A- Incollare la guarnizione mantenendo una protezione di carta di 100 mm su ogni lato.

B- Rimuovere i due pezzi di carta.

C- Incollare premendo su entrambe le estremità.

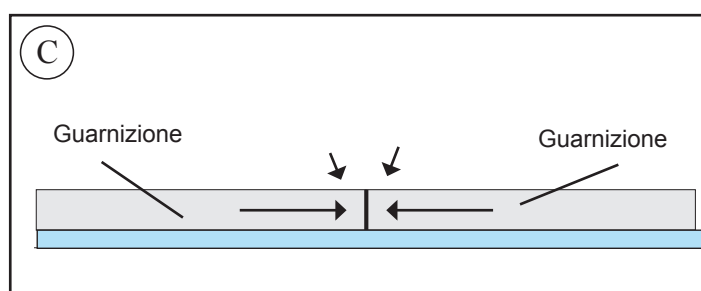
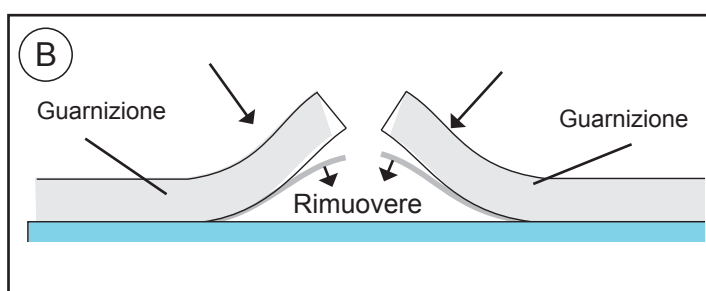
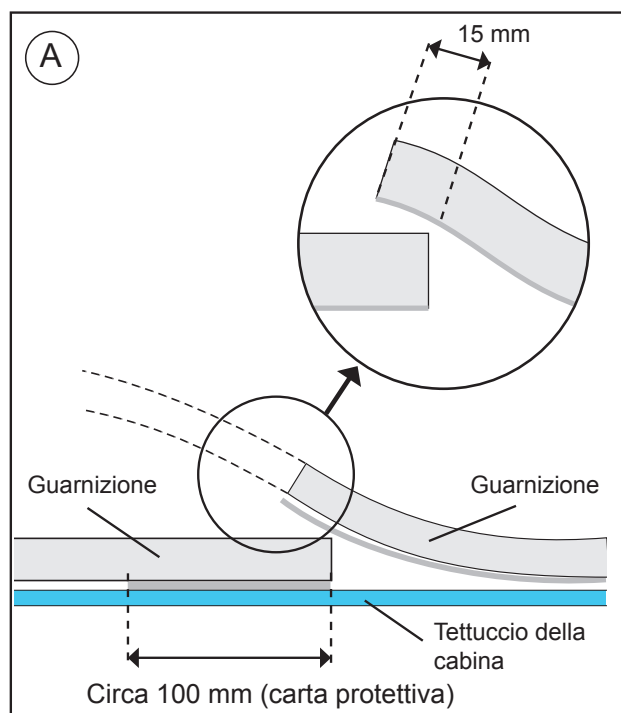

5 Inserire una rondella piana Ø 8 a testa larga e una rondella di gomma Ø 20 x Ø 7 x 3.



6 Sistemare l'impianto in posizione verticale, avvitare i perni esagonali negli inserti, rispettando la posizione indicata, e stringere con coppia di $12,7 \pm 10\%$ Nm.

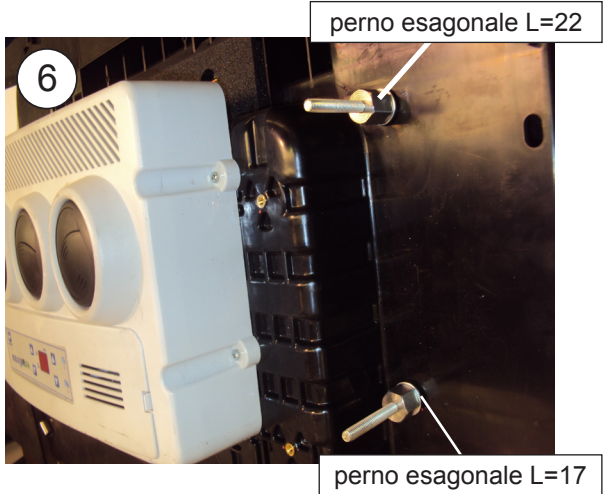
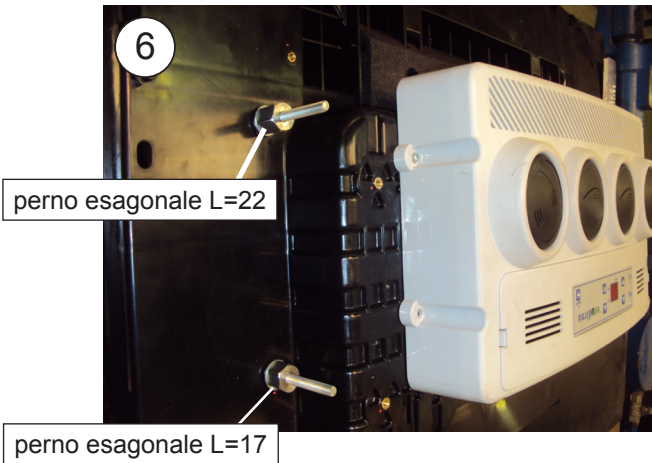

7 Avvitare (4) centratori sui supporti centratori rispettando posizione indicata.

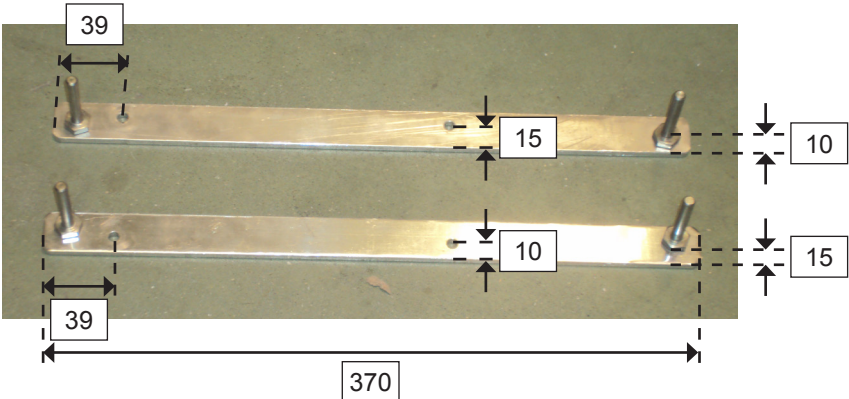

- 8** Montare i centratori sulla base con (4) viti (200TX40016) 4x16, rispettando la posizione indicata, con coppia di serraggio di 4,75x10% Nm.

Parte anteriore dell'impianto

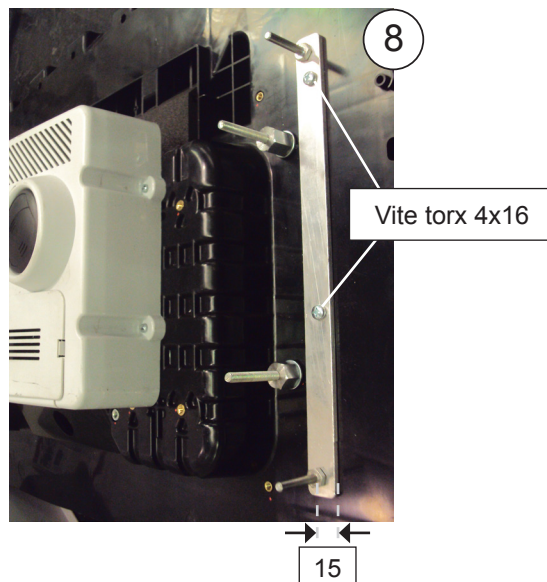
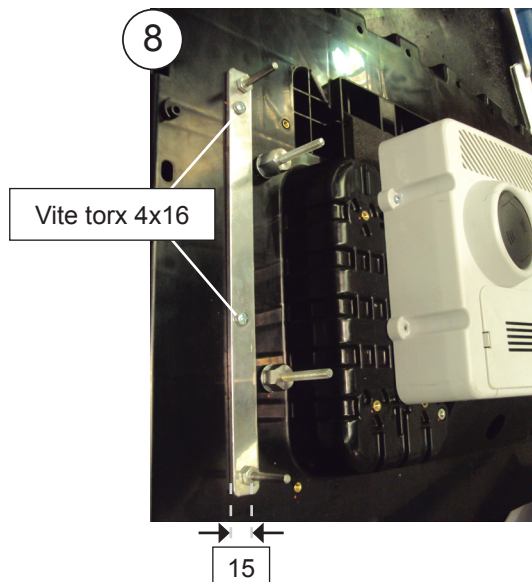

- 9** Sistemare l'impianto sul vano del tettuccio apribile, inserendo le guide nei fori (effettuati con l'autorizzazione del cliente) della cabina.

Attenzione: se l'impianto urta lo spoiler, segnare e tagliare quest'ultimo per agevolare l'inserimento.

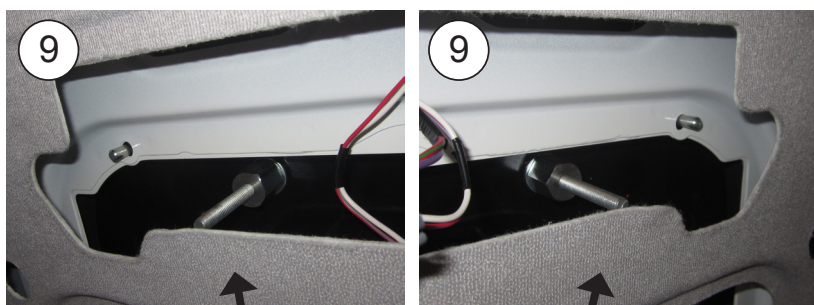

10 Inserire i supporti sulle viti prigioniere M8, al di sotto della tappezzeria.

Attenzione: è molto importante rimuovere le graffe di fissaggio del cablaggio del vano del tettuccio apribile, per evitare che i supporti schiaccino i cavi.

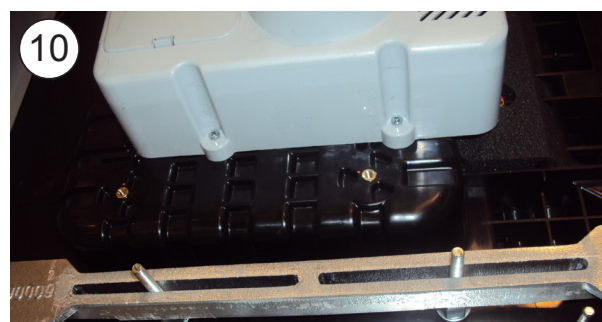

11 Montare i perni esagonali M6 sui supporti rispettando la posizione indicata e stringendo con coppia di serraggio.

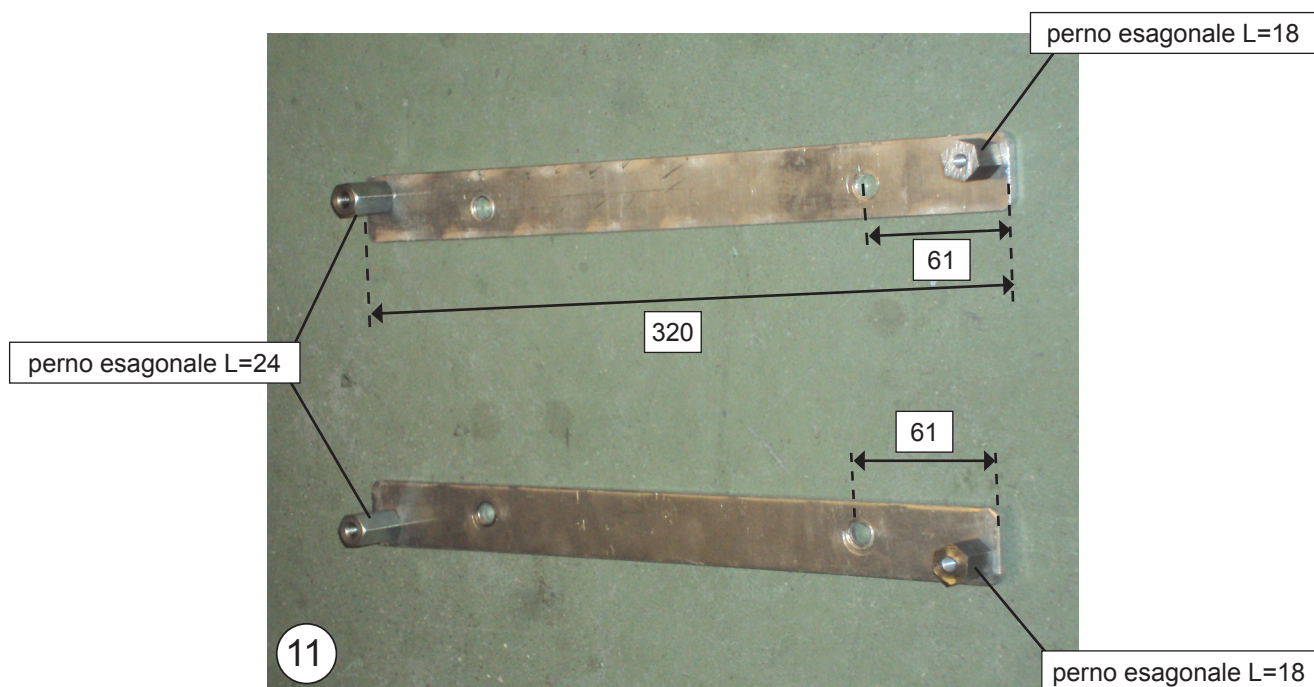

12

Inserire i supporti con i perni esagonali negli inserti M8, sui supporti di fissaggio. I perni esagonali devono stare all'esterno delle viti prigioniere: quelli con L=24 nella parte posteriore della cabina e quelli da 18 nella parte anteriore.

Vista lato sinistro cabina

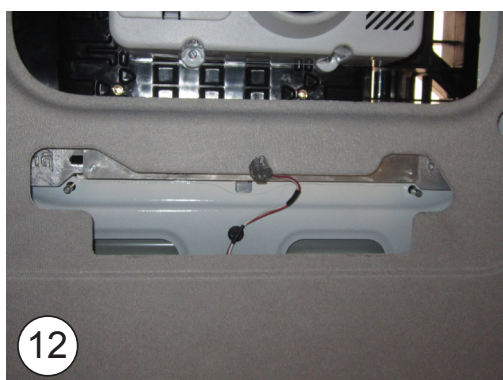

Vista lato destro cabina

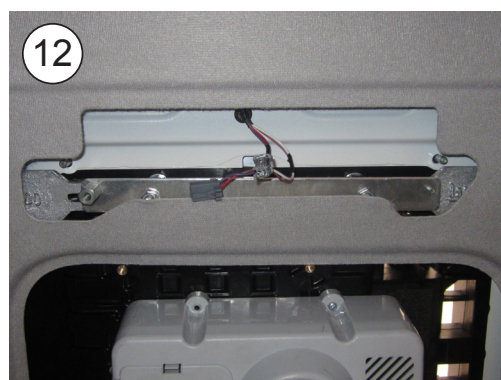
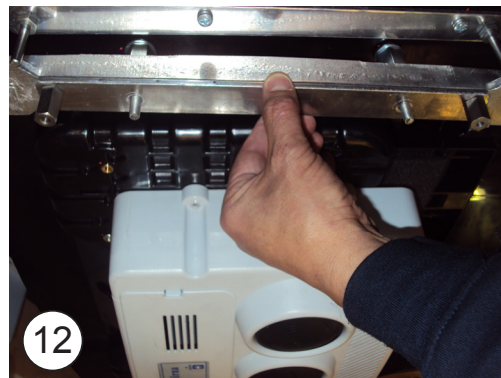
**13**

Inserire una rondella piana Ø 8 e un dado M8 autobloccante su ogni vite prigioniere.

Vista lato sinistro cabina



Vista lato destro cabina



14

Controllare che i supporti poggino correttamente sia sulla parte anteriore che su quella posteriore e che non si schiacci alcun cavo. Stringere i dadi M8 finché i supporti non sono a battuta con i perni esagonali della base.

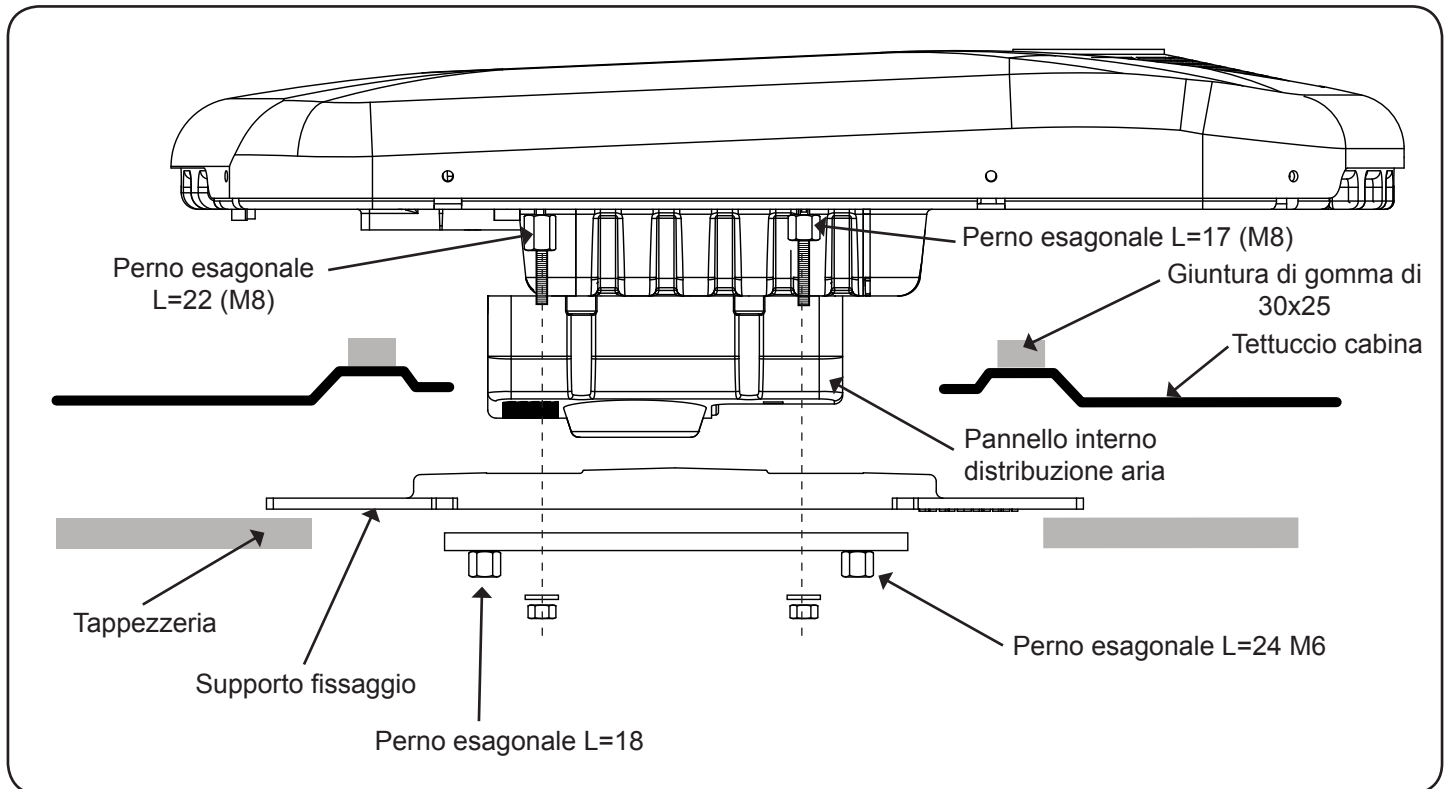
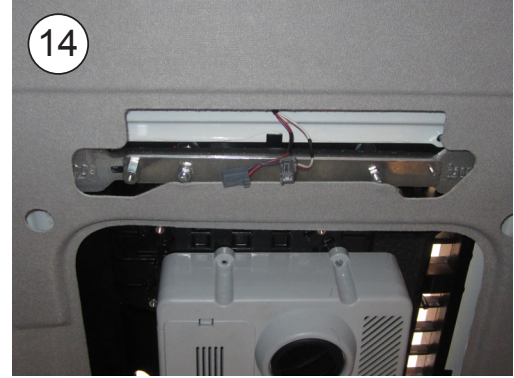
**15**

Montare la console sul pannello interno di distribuzione dell'aria e fissare con (4) viti 6/100x10 con testa Phillips e con (4) rondelle piane Ø 6 a testa larga avvitando sui perni esagonali.

- 16** Collegare le luci originali e inserirle nella console esercitando una leggera pressione.



- 17** Collegare il cablaggio di alimentazione dell'impianto, fissare i morsetti di connessione al tettuccio con supporti adesivi e fascette di plastica.

Attenzione: pulire bene la zona prima di incollare i supporti adesivi.

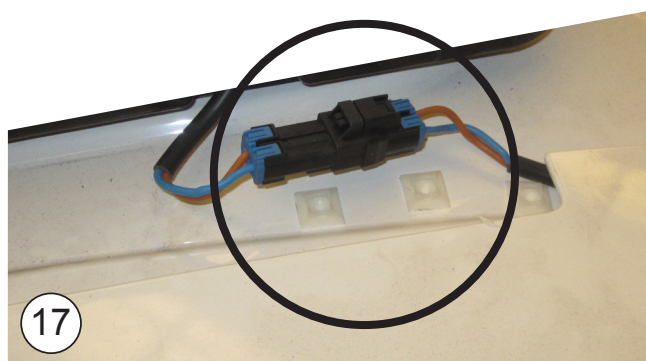
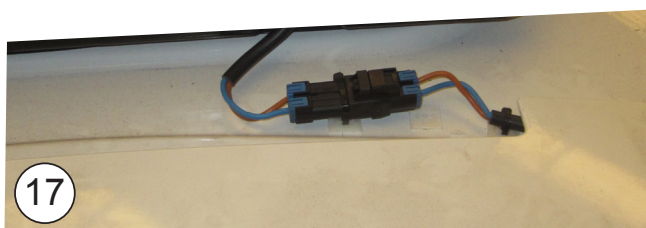

- 18** Allentare i supporti dello spoiler, lato destro, e farvi passare sotto il cablaggio attaccato allo spigolo della cabina e rimettere a posto i supporti dello spoiler.



19 Fissare il cablaggio sotto lo spoiler con supporti adesivi e fascette di plastica.

Attenzione: pulire bene la zona prima di incollare i supporti adesivi.



20 Con supporti adesivi e fascette, fissare il cablaggio alla cabina, al supporto dello spoiler laterale e al cablaggio originale.

Attenzione: pulire bene la zona prima di incollare i supporti adesivi.

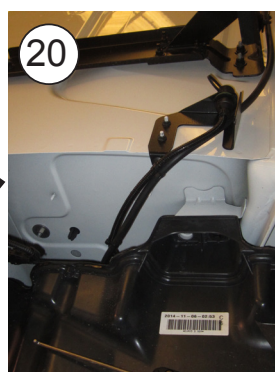
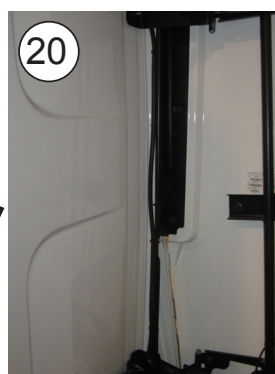

21

Ribaltare la cabina e passare il cablaggio sotto la protezione (*) verso la parte anteriore della cabina, fissandolo con le fascette al cavo originale.

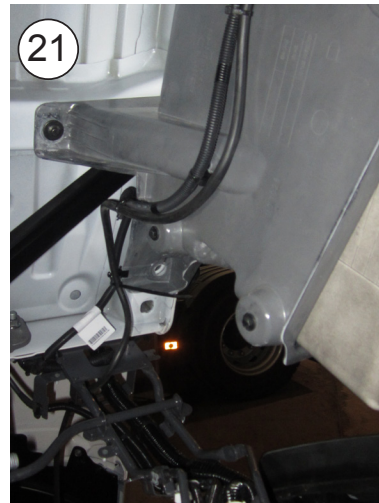
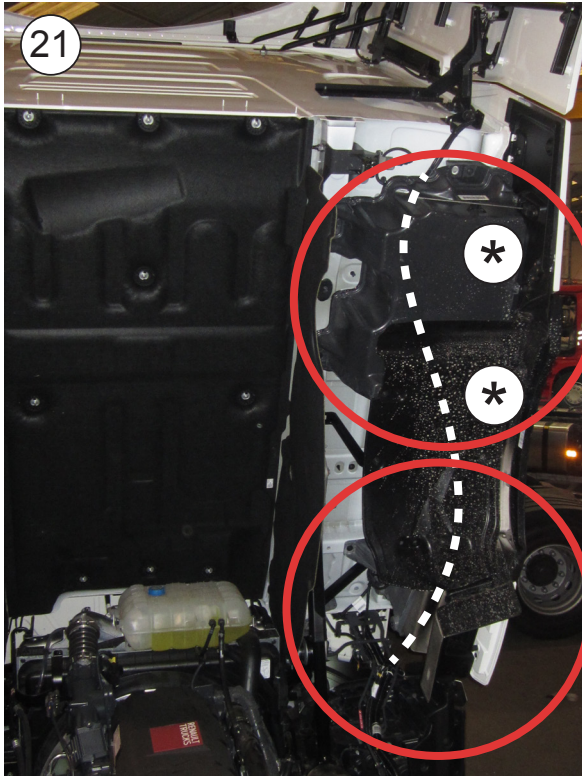

22

Rimettere la cabina in posizione di marcia e smontare i coperchi delle connessioni e del passaggio dei cablaggi originali (*).

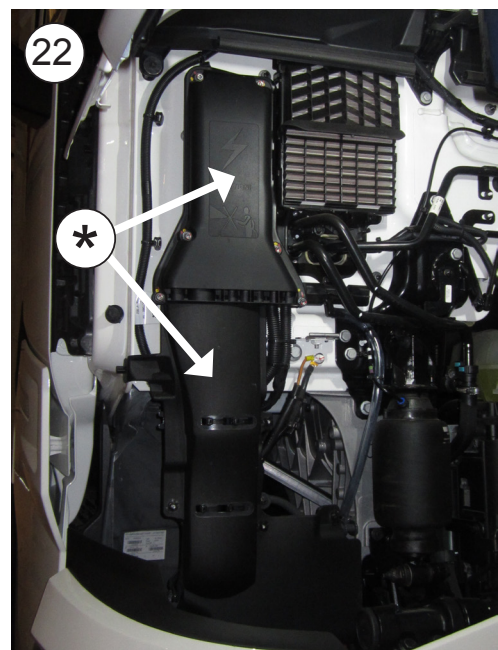

23

Collegare il cablaggio alle prese originali (+) e (-) facendolo passare con i cablaggi originali. Fissare il fusibile al cablaggio originale con una fascetta di plastica.

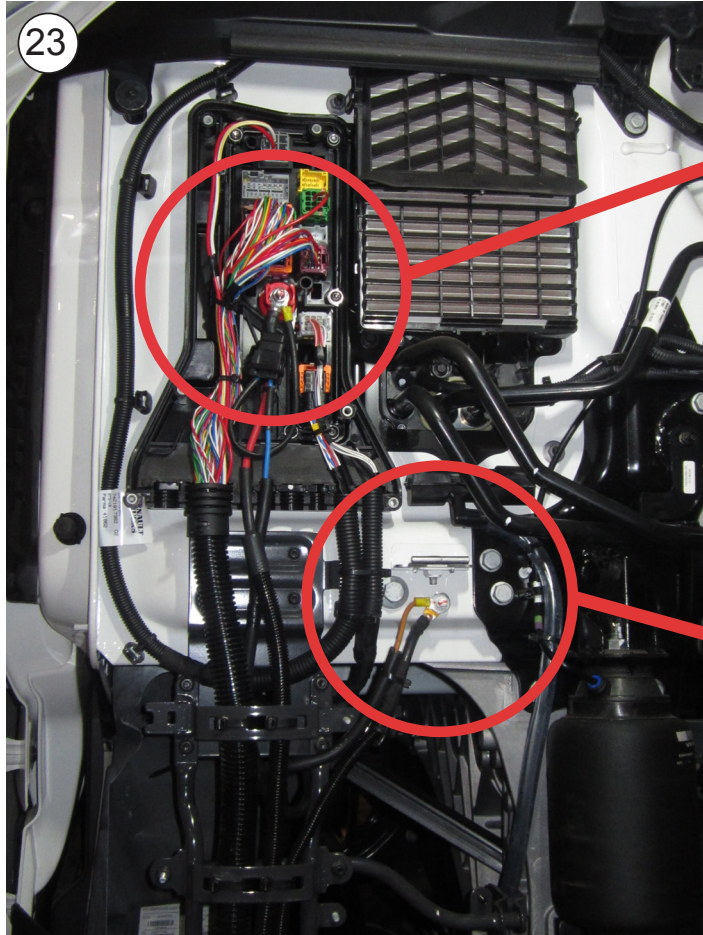
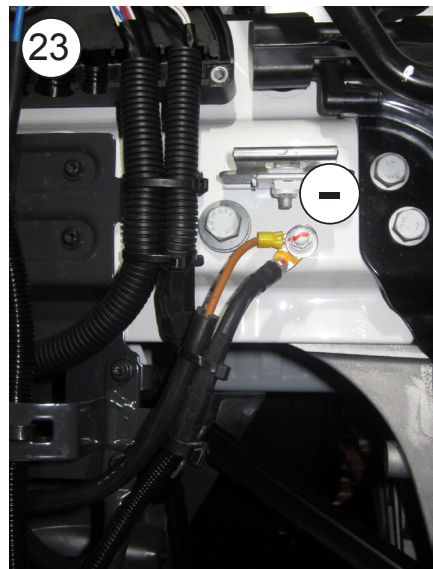
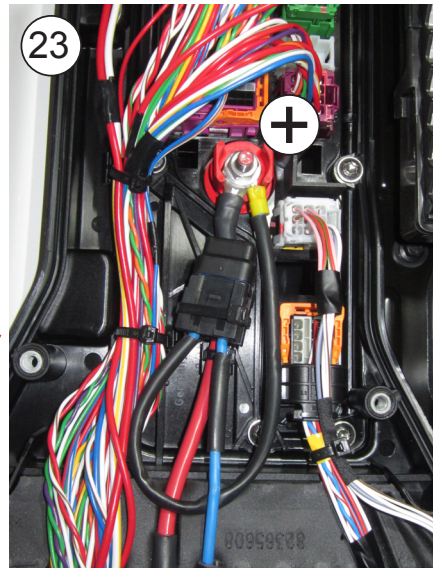

Attenzione: prima di mettere in funzione l'impianto, attendere almeno un'ora dopo aver lasciato la cabina in posizione di marcia.

Cablaggio elettrico

AVVISO IMPORTANTE!

Fare attenzione a non invertire le polarità quando si esegue il collegamento dell'impianto. Infatti, in tal caso il quadro comandi non si accende e l'impianto non funziona.

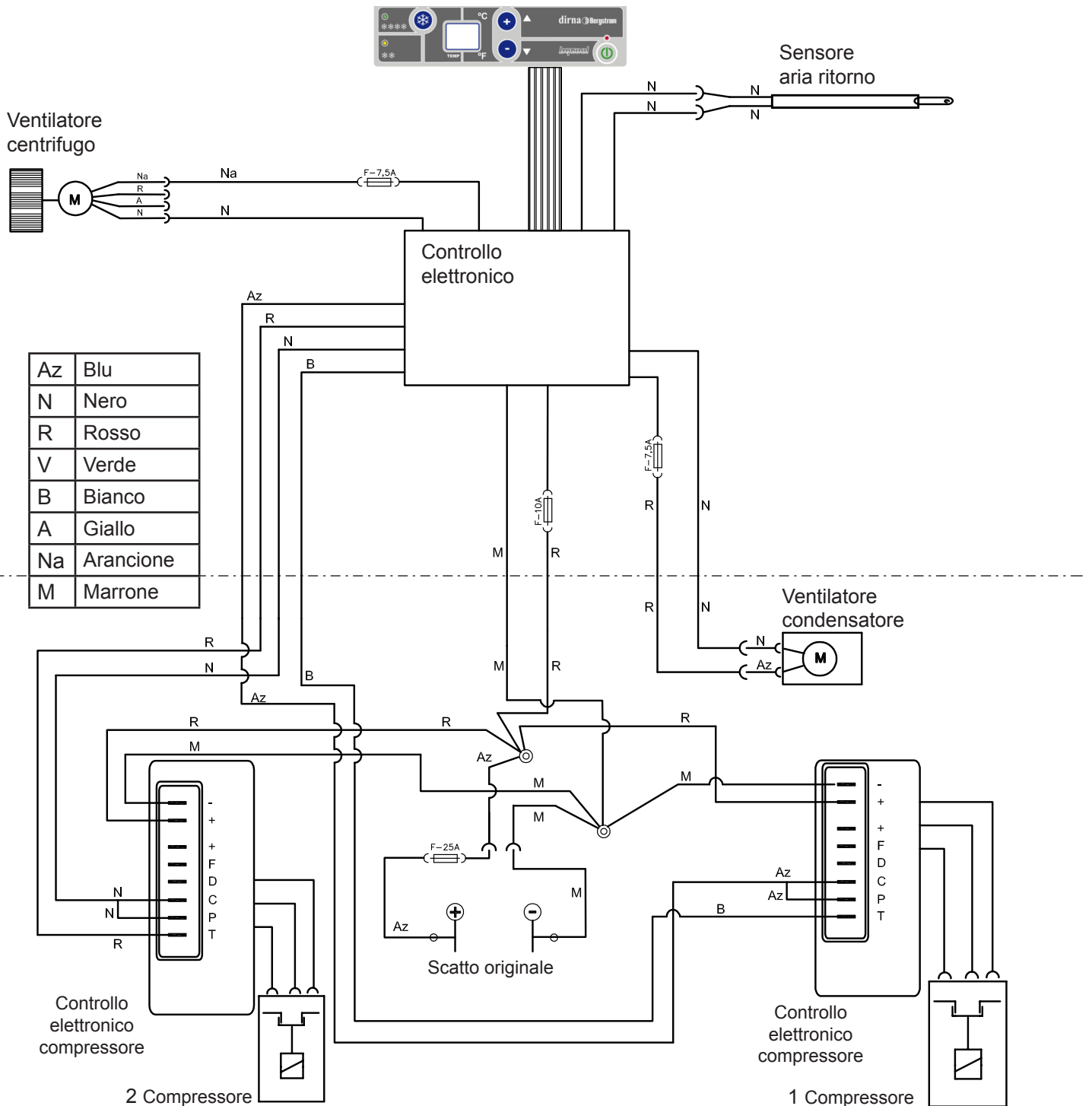

Ed:	30/06/2015
Md:	28/08/2019

d



Francisco Alonso, 6
28806 Alcalá de Henares, Madrid
SPAIN

Contact	Phone	Fax	E-Mail
Sales (Ventas Internacional)	+34 91 8770510	+34 91 8771158	sales@dirna.bergstrominc.com
Comercial Nacional	+34 91 8775841	+34 91 8836321	ventas@dirna.bergstrominc.com
Orders & Deliveries (Logística internacional)	+34 91 8775846	+34 91 8771158	export@dirna.bergstrominc.com
Orders & Deliveries (Logística nacional)	+34 91 8775840	+34 91 8836321	comercial@dirna.bergstrominc.com
Technical Assistance (Internacional)	+49 511 86679681	+49 511 86679710	technicalassistance@dirna.bergstrominc.com
Technical Assistance (Nacional)	+34 91 8775845	+34 91 883 6321	oblanco@dirna.bergstrominc.com

www.dirna.com

	ATENCIÓN:	Dirna Bergstrom se reserva el derecho de efectuar modificaciones en cualquier momento de los datos contenidos en esta publicación, por razones técnicas o comerciales.
	NOTE:	<i>For technical and commercial reasons, Dirna Bergstrom reserves the right to change the data contained in this brochure.</i>
	ATTENTION:	Dirna Bergstrom se réserve le droit d'effectuer à tout moment des modifications des données reprises sur cette publication, pour des raisons techniques ou commerciales.
	HIWEIS:	<i>Dirna Bergstrom behält sich vor, aus technischen oder kaufmännischen Gründen jederzeit Änderungen der Angaben dieser Veröffentlichung vorzunehmen.</i>
	ATTENZIONE:	Dirna Bergstrom si riserva il diritto di effettuare modifiche in qualsiasi momento ai dati contenuti in questa pubblicazione, per motivi tecnici o commerciali.